

Max-Planck-Institut für Mathematik Bonn

Apparent contours of nonsingular real cubic surfaces

by

Sergey Finashin
Vyatcheslav Kharlamov

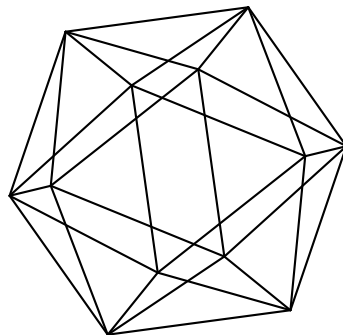

Apparent contours of nonsingular real cubic surfaces

Sergey Finashin
Vyatcheslav Kharlamov

Max-Planck-Institut für Mathematik
Vivatsgasse 7
53111 Bonn
Germany

Middle East Technical University
Department of Mathematics
Ankara 06800
Turkey

Université de Strasbourg
et IRMA (CNRS)
7 rue René Descartes
67084 Strasbourg Cedex
France

APPARENT CONTOURS OF NONSINGULAR REAL CUBIC SURFACES

SERGEY FINASHIN, VYATCHESLAV KHARLAMOV

We give a complete deformation classification of real Zariski sextics, that is of generic apparent contours of nonsingular real cubic surfaces. As a by-product, we observe a certain "reversion" duality in the set of deformation classes of these sextics.

CONTENTS

| | |
|--|----|
| 1. Introduction | 3 |
| 1.1. Main problem and principal results | 3 |
| 1.2. Contents of the paper | 4 |
| 1.3. Terminology conventions and notation | 4 |
| 1.4. Acknowledgements | 5 |
| 2. Zariski sextics | 5 |
| 2.1. Generic projection in the complex setting | 5 |
| 2.2. Generic projection in the real setting | 6 |
| 2.3. Restrictions on the arrangements of ovals and real cusps | 7 |
| 2.4. The code of a Zariski sextic | 8 |
| 2.5. The types I and II of (M-d)-curves | 9 |
| 2.6. Reversion of Zariski sextics | 9 |
| 2.7. The relation between the topology of cubic surfaces and their Zariski sextics | 10 |
| 2.8. Relation to the double covering cuspidal K3-surface Y | 11 |
| 2.9. Deformation classification statement | 12 |
| 3. Preliminaries on lattice theory | 12 |
| 3.1. Even lattices and their discriminants | 12 |
| 3.2. Groups with inner products and quadratic refinements | 14 |
| 3.3. The p-components | 14 |
| 3.4. The p-ranks of lattices | 15 |
| 3.5. The Brown invariant | 16 |
| 3.6. Elementary 2-groups with a quadratic refinement | 16 |
| 3.7. Elementary 3-groups with an inner product | 17 |
| 3.8. Extensions of lattices | 18 |
| 3.9. Gluing of lattices | 18 |
| 3.10. The orthogonal complement of ± 2 -elements | 19 |
| 3.11. Involutions via gluing | 20 |
| 3.12. Stability | 20 |
| 3.13. Different involutions with the same eigenlattices | 21 |
| 4. Topology and arithmetics of the covering K3-surfaces | 21 |
| 4.1. Covering K3 after desingularization | 21 |

2010 *Mathematics Subject Classification.* Primary 14P25, 14J28, 14J70, 14N25, 14H45.

The second author acknowledges a financial support by the grant ANR-09-BLAN-0039-01 of *Agence Nationale de la Recherche*.

| | |
|---|----|
| 4.2. Deficiency in the Smith inequalities | 22 |
| 4.3. Real varieties of type I | 23 |
| 4.4. Resolution decoration of $H_2(\tilde{Y})$ | 24 |
| 4.5. The Galois S_3 -coverings | 25 |
| 4.6. Abstract K3-lattice conical (Δ, h) -decorations | 27 |
| 4.7. S^0 -eigenlattices | 28 |
| 4.8. Geometric involutions | 28 |
| 4.9. T-pairs and T-halves | 29 |
| 4.10. Admissible T-halves and pairs of Möbius involutions | 30 |
| 5. Arithmetics of geometric involutions | 31 |
| 5.1. Automorphisms of 3-elementary inner product groups of small rank | 31 |
| 5.2. Reduction homomorphism | 32 |
| 5.3. Equivariant epistability of S^0 | 32 |
| 5.4. Gluing of involutions | 33 |
| 5.5. Realizability of T-pairs by geometric involutions | 34 |
| 6. Deformation classes via periods | 35 |
| 6.1. The complex period map | 36 |
| 6.2. The real period map | 39 |
| 6.3. Deformation classification via geometric involutions | 40 |
| 6.4. From a trigonal curve in Σ_4 to Zariski sextics in P^2 | 41 |
| 7. Arithmetics of the T-pairs | 42 |
| 7.1. Geography of the ascending T-pairs | 42 |
| 7.2. The list of T-halves | 45 |
| 7.3. Stability of the T-halves | 46 |
| 7.4. Simplest cases | 46 |
| 7.5. The case of $r_2 = r, r_3 = r - 1$ | 48 |
| 7.6. The case of $r_3 = r - 1, r_2 < r$ | 49 |
| 7.7. The list of ascending T-pairs | 51 |
| 7.8. Property of $(-\frac{1}{2})$ -transitivity for the eigenlattices T_- | 51 |
| 8. Back to Zariski curves | 54 |
| 8.1. Classification of geometric involutions | 54 |
| 8.2. Reversion roots | 54 |
| 8.3. Reversion partners of T-pairs | 54 |
| 8.4. Classification of real Zariski sextics | 56 |
| 8.5. The IDs of real Zariski sextics | 57 |
| 8.6. Proof of Theorem 2.9.1 | 59 |
| 9. Concluding Remarks | 59 |
| 9.1. Purely real statements | 59 |
| 9.2. Transversal pairs of conic and cubic | 60 |
| 9.3. Ordering of IDs | 61 |
| 9.4. Nonsingular partners | 62 |
| 9.5. Polygamy | 62 |
| References | 63 |

“*Tout n’est qu’apparence, non ?*”

Alberto Giacometti

1. INTRODUCTION

1.1. Main problem and principal results. There exist many ways to visualize cubic surfaces. One of those that take into account not only the internal geometry of the surface but also its position in the space, consists in “viewing the surface from an external point”, that is in considering central projections of the surface onto a plane and thus representing the surface as a 3-fold covering of the plane branched over a certain curve, called the *apparent contour* of the surface. If the cubic surface is nonsingular, such an apparent contour is a curve of degree 6 whose singular locus, for a generic choice of the center of projection, is formed by six cusps lying on a conic. Here, the condition of “generic choice” means certain transversality of the cubic surface to its first two polars with respect to the selected point, see Section 2.1 (in fact, the same kind of generic choice assumption is specific to the literature on Chisini conjecture, see, for example, [Mo] and [Ku1]).

The sextics with six cusps lying on a conic are called below *Zariski sextics*, following the “Arnold principle” [A]. The converse statement that any such a sextic is an apparent contour of some nonsingular cubic surface with respect to a generic center of projection is a classical observation (see [Sal], XIV.445 for the direct statement, and [Z1],[Z2] for the converse one). This correspondence establishes an isomorphism between the space of projective classes of pairs formed by a nonsingular cubic surface with a generic center of projection, and the space of projective classes of Zariski sextics. Therefore, studying of the former ones is reduced to studying of the latter, and it works equally well over \mathbb{C} and over \mathbb{R} .

G. Mikhalkin has undertaken analysis of the apparent contours of real nonsingular cubic surfaces and reported the results he obtained in [M]. Namely, he looked for a topological classification of the real apparent contours that are enhanced by specifying the topological type of the real locus of the cubic surface (such an enhancing can be expressed by coloring the part of the plane where the projection is three-to-one). Mikhalkin listed 49 *enhanced isotopy classes* of apparent contours that he constructed, mentioned 7 enhanced isotopy classes whose existence is uncertain, and claimed that there are no others. Our research resulted from attempts to understand Mikhalkin’s results, to find the proofs, to complete the classification and, overall, to sharpen it by providing a classification up to *equisingular deformations*. Recall that for plane reduced curves, which is our case, equisingular deformations can be defined in topological terms, as continuous families of algebraic curves preserving the quantity of singular points and their Milnor numbers. Thus, in our setting the equisingular deformation classes of the apparent contours of nonsingular real cubic surfaces are nothing but the connected components of the space of real Zariski sextics.

To obtain such a *deformation classification* of apparent contours, we analyze the K3-surfaces that we obtain as double covers of the plane branched along Zariski curves. This is an approach, which had already proved its efficiency in many real algebraic classification problems related to sextic curves, see [Kh2], [N1], [It] (as well as in related problems of complex geometry, see [N2], [D1]). Kulikov’s theorem of surjectivity of the period map for K3-surfaces (see [Ku2]) allows us to reduce the classification up to deformation to a classification of certain involutions on the K3-lattice (so called “geometric involutions”, see Section 4.8 for precise definitions) and Nikulin’s results on arithmetics of integral lattices (see [N1]) help to make the final classification explicit.

As a result, we prove that there exist precisely 68 deformation classes of apparent contours. In turn, we find that 7 Mikhalkin’s uncertain enhanced isotopy classes are actually realizable and that, moreover, there exist 6 more enhanced isotopy classes missing in his list; the full list of enhanced isotopy classes contains 62 items. The difference, also equal to 6, between the number of deformation classes and the number of enhanced isotopy classes is due to existence of 6 pairs-twins of deformation classes, such that the twins in each pair give the same isotopy class of

apparent contours and the same topological type of the cubic surface, but differ by the complex type of the underlying Zariski sextic, which can be dividing or not dividing.

The final classification is presented at two levels. The first level classification statement consists in establishing a one-to-one correspondence between the set of deformation classes and the set of geometric involutions on the K3-lattice (see Theorem 6.3.1). The second level of classification consists, on one hand, in an enumeration of geometric involutions in terms of their eigenlattices, a kind of “imaginary invariants” of the apparent contours (see Theorem 7.7.1), and, on the other hand, in an enumeration of the ID’s of Zariski sextics (see Theorem 2.9.1), which look more like “real invariants”. Here an ID is, roughly speaking, just an enhanced isotopy type with an additional bit of information specifying whether a sextic is dividing or not dividing.

The list of the ID’s of Zariski sextics that we give in Theorem 2.9.1 is organized in a way to emphasize some duality resulted from the classification. This duality splits 62 of the deformation classes into 31 pairs (so that only 6 remaining deformation classes are left without a pair). Geometrically, in terms of arrangement of components (and their cusps) of a real Zariski sextic, this duality can be described as a certain reversion, see details in Section 2.6. In Section 6.4 we give a “conceptual” explanation of this duality via a “wall crossing” of special faces that can be found on all but six exceptional fundamental period domains in the period space of our K3-surfaces. Such special faces correspond to degeneration of Zariski sextics to a triple conic by means of families of the form $Q^3 + tf_2Q^2 + t^2f_4Q + t^3f_6$ (more precisely, of the form $Q^3 + t(f_1(x, y, z)Q + tf_3(x, y, z))^2 = 0$), and the K3-surface resulting in the limit of such a family at $t = 0$ is an appropriate double cover of the ruled surface Σ_4 , so that the duality in terms of these K3 surfaces results in twisting the real structure by the deck transformation of the covering, or equivalently, in terms of the families, it results in changing the sign of t , that is in switching to $Q^3 - tf_2Q^2 + t^2f_4Q - t^3f_6$ (which is equivalent to switching the sign of Q).

1.2. Contents of the paper. The paper is organized as follows. In Chapter 2 we introduce Zariski sextics, establish their relation to cubic surfaces and study the principal properties of Zariski sextics and the double planes branched along the Zariski sextics; we conclude the chapter with our main deformation classification statement. In Chapter 3, which is devoted to the arithmetics of integral lattices, we recall the basic definitions and some well-known results on lattices (their discriminant finite forms, gluing of lattices, and involutions), slightly developing them and making a special emphasis on the lattices that have only discriminant factors 2 and 3, since it is this kind of lattices that appear later on in the proofs of the main results. Chapter 4 deals with our main object of investigation, the K3-surfaces that are the double coverings of the plane branched along the Zariski sextics. Here, we relate topological and geometrical properties of these surfaces with the arithmetics of K3-lattices. In particular, we introduce and study *geometric involutions* on the K3-lattices and associated with them *admissible T-pairs*.

Chapter 5 is devoted to studying the action of geometric involutions on the lattice generated by exceptional divisors. There we prove the realizability of all the admissible *T-pairs* via geometric involutions. In Chapter 6 we introduce the period space for K3-surfaces that are double coverings of the plane branched along Zariski sextics, check that up to codimension two the periods of our K3-surfaces fill out the fundamental domains of a group generated by reflections, and deduce from that the bijection between the set of deformation classes of real Zariski sextics and the set of conjugacy classes of ascending geometric involutions. In Chapter 7 we classify admissible ascending *T-pairs* and prove their stability. Finally, in Chapter 8 we apply the results of preceding Chapters and enumerate the geometric involutions, and hence the deformation classes of real Zariski sextics, in terms of *T-pairs*. We conclude with translating the classification into the language of IDs of real Zariski sextics, which proves the deformation classification statement formulated in Chapter 2. A few final remarks are collected in Chapter 9.

1.3. Terminology conventions and notation. A *real algebraic variety* is always considered

as a pair (X, c) , where X is a complex one and $c: X \rightarrow X$ is an anti-holomorphic involution called *the complex conjugation*, or *the real structure*. The locus of complex points of X is denoted by $X(\mathbb{C})$, and the real locus, $\text{Fix } c$, by $X(\mathbb{R})$. In some cases, when it causes no confusion, we denote also the induced involution in the homology.

When we speak on singular points and on (equisingular) deformations, we take into account not only the real points but the complex ones as well. For example, from such a viewpoint, the real Zariski sextics having no real points can be not only different but even non equivalent up to equisingular deformations; in fact, such “empty Zariski sextics” form two distinct deformation classes (a twin pair of dual classes in the sense mentioned above).

Working with homology or cohomology we use by default \mathbb{Z} -coefficients, dropping them from the notation. In the case of compact oriented even dimensional manifolds, especially in the case of complex $K3$ -surfaces, we identify the middle homology and cohomology lattices via Poincaré duality up to omitting, with a slight abuse of notation, the duality operator.

The symbol \square is used to mark the end of a remark.

1.4. Acknowledgements. We thank G. Mikhalkin for sending to us his personal notes with the figures illustrating construction of the Zariski sextics listed in [M]. This work was essentially done during the visits of the first author to Strasbourg University and partially during our visits to MPIM (Bonn); we thank the both institutions for providing good working conditions.

2. ZARISKI SEXTICS

2.1. Generic projection in the complex setting. Let X be a non-singular cubic surface in P^3 defined by a homogeneous cubic polynomial $f = f(x_0, \dots, x_3)$, $\xi = [\xi_0 : \dots : \xi_3]$ a point in $P^3(\mathbb{C}) \setminus X(\mathbb{C})$, and $\pi = \pi_{X, \xi}: X \rightarrow P^2$ the central projection from ξ . The critical set of π is the curve $B = B_{X, \xi} = X \cap X_\xi$ traced on X by *the polar quadric*, X_ξ , defined by $f_\xi = \sum_{i=0}^3 \xi_i f_{x_i}$. We call this curve $B \subset X$ the *rim-curve*. The set of critical values, $A = \pi(B)$, is called the *apparent contour of X with respect to ξ* . The lines passing through ξ and intersecting B trace on X another curve, B' , which we call the *shadow contour*, so that $\pi^{-1}(A) = B \cup B'$.

We say that a point ξ is *X-generic* if X_ξ is transverse to X , and B is transverse to *the Hessian plane* $X_{\xi\xi}$ defined by $f_{\xi\xi} = \sum_{i,j=0}^3 \xi_i \xi_j f_{x_i x_j}$. Clearly, the set of X -generic points ξ is a Zariski-open subset of P^3 .

Let us choose a coordinate system so that $\xi = [0 : 0 : 0 : 1]$ and f turns in a depressed form $f = x_3^3 + px_3 + q$, where p and q are homogeneous polynomials in x_0, x_1, x_2 of degrees 2 and 3 respectively. We say that such a coordinate system is *associated with X and ξ* (it is well-defined up to a coordinate change in the projection plane $P^2 = \{[x_0 : x_1 : x_2]\}$).

2.1.1. Lemma. *In a coordinate system associated with X and ξ ,*

- (1) *the polar quadric X_ξ is $\{3x_3^2 + p = 0\}$,*
- (2) *the Hessian plane $X_{\xi\xi}$ is $\{x_3 = 0\}$,*
- (3) *the apparent contour A is the sextic defined by the discriminant polynomial $D_f = 4p^3 + 27q^2$ of f ,*
- (4) *the shadow-contour B' is given by equations $3x_3^2 + 4p = 0, x_3^3 + px_3 + q = 0$.*

Proof. Straightforward calculation. \square

2.1.2. Corollary. *Assume that ξ is X -generic. Then,*

- (1) *the rim curve B and the shadow-contour B' are nonsingular and intersect each other at the 6 points $X \cap X_\xi \cap X_{\xi\xi}$ with multiplicity 2 (i.e., B and B' have simple tangency at these points);*
- (2) *the apparent contour A is smooth except the 6 cuspidal points at $\pi(X \cap X_\xi \cap X_{\xi\xi})$. \square*

2.1.3. Corollary. *The point ξ is X -generic if and only if the conic p and cubic q intersect transversely, and the sextic A has no other singularities except the 6 cusps at $p = q = 0$. \square*

If a sextic has six cusps on a conic and no other singular points, we call it *Zariski sextic*. The following fact is well known and can be deduced from various results found in the literature; for the reader's convenience we supply it with an elementary straightforward proof.

2.1.4. Proposition. *A plane sextic is a Zariski sextic if and only if it is the apparent contour of a nonsingular cubic surface X with respect to an X -generic point. In particular, a Zariski sextic is presented by equation $4p^3 + 27q^2$, where p and q are homogeneous polynomials of degree 2 and 3 defining a conic and a cubic intersecting transversely. Such a presentation is unique up to rescaling $(p, q) \mapsto (t^2p, t^3q)$. \square*

Proof. Consider a Zariski sextic $A = \{f_6 = 0\}$ that have cusps at points P_1, \dots, P_6 lying on a conic $B = \{f_2 = 0\}$. Note that, first, for any irreducible cubic passing through the points P_i , $i = 1, \dots, 6$, these points are smooth, and, second, there exists a cubic $\{f_3 = 0\}$ whose tangents at P_1, P_2, P_3 are also tangent to the cusps of A .

Then, for some $\alpha \neq 0$, $g = f_6 - \alpha(f_3)^2$ has at least multiplicity 3 at P_1 , and thus, by the Bezout theorem, it is reducible, $g = f_2f_4$. The residual quartic $Q = \{f_4 = 0\}$ has at least multiplicity 2 at P_1 and passes through P_i , $2 \leq i \leq 6$. Localizing the equation of f_6 at points P_2 and P_3 , we can see that $f_6 = \alpha(f_3)^2 + f_2f_4$ cannot yield a cusp tangent to $f_3 = 0$, if f_4 is smooth at these points. This implies that f_4 has at least multiplicity 2 at P_2 and P_3 , so that by the Bezout theorem, $f_4 = f_2f'_2$. Here the conic $f'_2 = 0$ passes through P_1, P_2, P_3 , and does not pass through some of P_i , $4 \leq i \leq 6$, unless it coincides with B . Localizing $f_6 = \alpha(f_3)^2 + f_2^2f'_2$ at such a point, we obtain a non-degenerate double point rather than a cusp. Therefore, f'_2 coincides with B , and thus, $f_6 = \alpha(f_3)^2 + \beta(f_2)^3$.

If $f_6 = 4p^3 + 27q^2$, then the cubic $q = 0$ is tangent to each of the 6 cusps of f_6 . Hence, it is unique up to rescaling (indeed, by Bezout theorem two different cubics can not be tangent at 6 points). \square

2.1.5. Corollary. *The central projection provides an isomorphism between the space of projective classes of Zariski sextics and the space of projective classes of pairs (X, ξ) , where X is a nonsingular cubic surface and a point ξ is X -generic. \square*

Proof. The both spaces are quasi-projective varieties and by Proposition 2.1.4 the map provided by the central projection is one-to-one. \square

2.2. Generic projection in the real setting. From now on, we restrict our considerations to cubic surfaces X defined over \mathbb{R} and points ξ in $P^3(\mathbb{R}) \setminus X(\mathbb{R})$. However, we assume everywhere that the chosen point ξ is X -generic over \mathbb{C} , in the sense of Section 2.1.

Since X, ξ are real, their Zariski sextic is real as well, and vice versa. More precisely, Proposition 2.1.4 and Corollary 2.1.5 imply the following.

2.2.1. Proposition. *The central projection provides an isomorphism between the three spaces:*

- (1) *the set of real projective classes of real Zariski sextics,*
- (2) *the set of pairs (p, q) where p and q are real homogeneous polynomials of degree 2 and 3, respectively, considered up to simultaneous real projective transformations of variables and satisfying two restrictions: first, the conic $p = 0$ and the cubic $q = 0$ intersect transversally, and, second, the sextic $p^2 + q^3 = 0$ has no other singularities than 6 cusps;*
- (3) *the set of real projective classes of pairs (X, ξ) , where X stands for a nonsingular real cubic surface and ξ for a real X -generic point. \square*

Remark. Recall that according to our convention, transversality is assumed at all the complex points, and that some of the six cusps of a real Zariski curve may be imaginary.

Let \mathcal{P}_\pm denote the region $\{\pm p \leq 0\}$ bounded in $P^2(\mathbb{R})$ by our real conic p . Next, $P^2(\mathbb{R})$ is divided into two ‘‘halves’’ bounded by $A(\mathbb{R})$, namely $\mathcal{A}_\pm = \{[x] \in P^2(\mathbb{R}) \mid \pm D_f(x) \geq 0\}$. Note that a Zariski sextic determines uniquely the sign of its degree 6 polynomial $D_f = 4p^3 + 27q^2$, as well as the sign of p , and therefore determines the signs of the above regions, \mathcal{P}_\pm and \mathcal{A}_\pm .

2.2.2. Lemma.

- (1) *The real part of the apparent contour, $A(\mathbb{R})$, lies entirely in \mathcal{P}_+ .*
- (2) *The projection $p_{\mathbb{R}} = p|_{X(\mathbb{R})}$ is three-to-one over the interior points of \mathcal{A}_- and one-to-one over the interior of \mathcal{A}_+ .*
- (3) *The region \mathcal{A}_- lies entirely in \mathcal{P}_+ and bounds the real cusps of A from the sharp side, see Figure 1.*



FIGURE 1. Zariski sextic on the right is obtained by a small perturbation $4(\epsilon p)^3 + 27q^2 = 0$ of the conic $p = 0$ and cubic $q = 0$ shown on the left; $p < 0$ inside the conic and $\epsilon > 0$.

Note that one of the regions \mathcal{A}_\pm is orientable, and the other is not; let us denote them respectively \mathcal{A}_o and \mathcal{A}_n , thinking of o and n as functions of (X, ξ) taking opposite values $o, n \in \{+, -\}$. Then, in accordance with Lemma 2.2.2, $o = +$ if and only if the projection $p_{\mathbb{R}} = p|_{X(\mathbb{R})}$ is three-to-one over the interior points of the non-orientable component of $P^2(\mathbb{R}) \setminus A(\mathbb{R})$. Due to Lemma 2.1.4, these functions o and n can be also considered as functions of A .

The connected components of $A(\mathbb{R})$ will be called *ovals*. An oval may have real cusps; it is called *cuspidal* in this case and *smooth* otherwise.

2.3. Restrictions on the arrangements of ovals and real cusps.

2.3.1. Lemma. *Every cuspidal oval of a real Zariski sextic has an even number of cusps.*

Proof. Every component of the real rim-curve $B(\mathbb{R})$ is two-sided on $X(\mathbb{R})$, hence, null-homologous in $P^3(\mathbb{R})$. Therefore, $B(\mathbb{R})$ intersects the plane $X_{\xi\xi}$ at an even number of points. But it is these points that are projected into the cusps of the corresponding oval, see Corollary 2.1.2. \square

We denote by $2\nu_i$ the number of the imaginary cusps of A , and by $2\nu_r$ the number of real ones, so that $\nu_i, \nu_r \geq 0$, and $\nu_i + \nu_r = 3$.

Every oval, O , of a Zariski sextic A is obviously null-homologous in $P^2(\mathbb{R})$, and thus, divides the latter into *the interior of O* (homeomorphic to a disc), and *the exterior of O* (homeomorphic to a Möbius band). A cusp on O may be directed towards the interior, or the exterior, of O and we call it an *inward cusp*, or *outward cusp*, respectively. The following statement follows directly from the definition of \mathcal{P}_\pm and \mathcal{A}_\pm .

2.3.2. Lemma. *Any cusp of an oval $O \subset A(\mathbb{R})$ is inward, if the region \mathcal{P}_+ lies in the interior of O , and outward, if it lies inside the exterior. All the real cusps are directed from \mathcal{A}_- to \mathcal{A}_+ . \square*

2.3.3. Corollary. *All the cusps on an oval of a real Zariski curve are alike: either all inward, or all outward. \square*

2.3.4. Corollary. *For any real Zariski sextic the following properties hold:*

- (1) *there can not be more than one oval with inward cusps;*
- (2) *all the ovals in the exterior of an oval with inward cusps are smooth;*
- (3) *all the ovals in the interior of an oval with outward cusps are smooth;*
- (4) *if one of external ovals has an outward (inward) cusp, or one of internal ovals has an inward (resp. outward) cusp, then $o = -$ (resp. $o = +$). \square*

2.3.5. Lemma. *If some oval of a real Zariski sextic is non-empty, then no other its oval may contain (a) an inward cusp, (b) more than two outward cusps.*

Proof. (a) If an inward cusp is on an external oval, then we take a line passing through this cusp and a point inside an internal oval. If an inward cusp is on an internal oval, then it contains another cusp and we take a line through both of them. In each of the cases there will be a contradiction to the Bezout theorem.

(b) If there is more than two outward cusps on an external oval, Ω , then we take a line passing through an internal oval and one of the four cusps on Ω chosen so that this line intersects Ω at some other point (it is possible, since it contains > 2 cusps). If more than two, and thus, at least four outward cusps lie on an internal oval, Ω , then we can find a line passing through two of the cusps and intersecting Ω in at least one more point. This will also contradict to the Bezout theorem. \square

2.3.6. Lemma. *There cannot be more than one smooth empty oval bounding a disc containing in \mathcal{A}_- . In particular, there cannot be more than one smooth empty oval neither in the interior of an oval with inward cusps, nor in the exterior of a non-empty oval with outward cusps.*

Proof. The projection $p_{\mathbb{R}}$ is 3-fold over \mathcal{A}_- , so, smoothness of the ovals implies that $X(\mathbb{R})$ must have spherical components projecting to the discs in \mathcal{A}_- bounded by these ovals. On the other hand, $X(\mathbb{R})$ has at most one spherical components. \square

2.4. The code of a Zariski sextic. The ambient differential-topological type of $A(\mathbb{R})$ in $P^2(\mathbb{R})$, A being a Zariski sextic, is characterized by a certain code of A , which is defined as follows.

An oval with $2 \leq 2k \leq 6$ cusps has code 1_k if the cusps are outward, and 1_{-k} if the cusps are inward; a smooth oval has code 1. The codes n and n_1 are abbreviations for $1 \sqcup \dots \sqcup 1$ and $1_1 \sqcup \dots \sqcup 1_1$ that denote a group of n empty ovals, which are all smooth, or respectively, all have 2 outward cusps (recall that according to Corollary 2.3.4 groups of $n \geq 2$ ovals with inward cusps are impossible). For an arrangement in which an oval O contains inside a set of ovals with the code S , we use the code $1_k \langle S \rangle$, $1_{-k} \langle S \rangle$, or $1 \langle S \rangle$ (depending on the number and the direction of cusps on O). A few examples are shown on Figure 2.

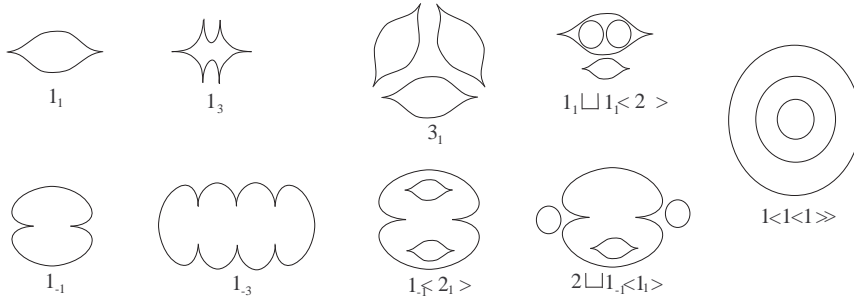

FIGURE 2.

We may also ignore the cusps and describe the purely topological (i.e., class C^0) arrangements of ovals by dropping the subscripts from the codes. The result is called *the simple code of A* : it looks like α if all the ovals are empty, like $\alpha \sqcup 1\langle\beta\rangle$ if one of the ovals contains β ovals inside and α ovals outside, or like $1\langle 1\langle 1\rangle\rangle$, if there is a nest of three ovals. It is convenient to allow sometimes an alternative form of this code, and write $\alpha \sqcup 1\langle 0\rangle$ for an arrangement of $\alpha + 1$ empty ovals. For the empty set of ovals ($A(\mathbb{R}) = \emptyset$), we use the code 0 and call it the *null-code*. The code $1\langle 1\langle 1\rangle\rangle$ is called the *3-nest code*.

2.4.1. Lemma. *Assume that a real sextic A has six cusps and no other singular points. Then the arrangement of its ovals has one of the following simple codes:*

- (1) $\alpha \sqcup 1\langle\beta\rangle$, $0 \leq \alpha, \beta \leq 4$, $\alpha + \beta \leq 4$,
- (2) 0,
- (3) $1\langle 1\langle 1\rangle\rangle$.

Proof. It follows from the Bezout theorem and Harnack's estimate of the number of ovals (see Subsection 2.5), like in the well-studied case of non-singular sextics, see, for example, Gudkov's survey [G]. \square

2.4.2. Lemma. *A real sextic cannot have real singular points, if its real locus is a union of three nested ovals.*

Proof. A line through a point inside the internal oval of the nest intersects such a sextic in 6 real points, which should be all non-singular not to contradict to the Bezout theorem. \square

2.5. The types I and II of (M-d)-curves. Recall that the *Harnack inequality* $\ell(A) \leq g(A) + 1$, which bounds the number of connected components, $\ell(A)$, of $A(\mathbb{R})$ for a non-singular real curve A in terms of its genus, $g(A)$, extends to singular irreducible curves as soon as one understands by $\ell(A)$ and $g(A)$ the number of components and the genus after normalization. Real curves with $\ell(A) = g(A) + 1$ are called *M-curves*. Let $d(A) = g(A) + 1 - \ell(A)$. If $d = d(A) > 0$, then a curve is called an *(M-d)-curve*.

An irreducible curve A is said to be of *type I* if $A(\mathbb{C}) \setminus A(\mathbb{R})$ is disconnected (i.e., has two components), and of *type II* otherwise. The following is well-known.

2.5.1. Lemma. *Assume that A is a real irreducible curve. Then:*

- (1) A is of type I, if it is an M-curve.
- (2) A is of type II, if it is an (M-d)-curve, where d is odd.

If A is a real sextic whose real locus is a nest of three ovals, then A is of type I. \square

2.5.2. Corollary. *A real Zariski sextic has at most 5 ovals. It is of type I if it has 5 ovals, and of type II if it has 4, 2, or no ovals.* \square

2.6. Reversion of Zariski sextics. Given an arrangement $D \subset \mathbb{RP}^2$ of ovals (smooth, or cuspidal), a point $p \in \mathbb{RP}^2 \setminus D$, and a simple closed one-sided curve $L \subset \mathbb{RP}^2 \setminus (D \cup \{p\})$, one can obtain another arrangement of ovals, D' on the projective plane $\mathbb{RP}_{p,L}^2$ obtained from the given one by contracting L and blowing up p . If we pass to the isotopy classes of D and D' , one can identify $\mathbb{RP}_{p,L}^2$ with the initial \mathbb{RP}^2 and observe that the result of this operation depends only on the choice of the component of $\mathbb{RP}^2 \setminus D$ containing p . An alternative description of this operation is to pick up an annulus neighborhood of D , $D \subset N \subset \mathbb{RP}^2$, $N \cong S^1 \times [-1, 1]$, and let $D' \subset \mathbb{RP}^2$ be the image of D under the reversion mapping $N \rightarrow N$, $(x, t) \mapsto (x, -t)$. We say that D and D' (considered up to isotopy) are *in reverse position* with respect to annulus N , or with respect to point p , and call this operation *reversion of D* . An oval containing the point p inside, or equivalently, homologically non-trivial in N , will be called a *principal oval of a reversion*.

We say that $D \subset N \cong S^1 \times [-1, 1]$ is *trigonal with respect to N* , if each segment $x \times [-1, 1] \subset N$ intersects transversely D at one or three points, except finitely many critical values of x for which

segment $x \times [-1, 1]$ is tangent to D or contains a cusp whose tangent is transverse to this segment. The following observations are trivial.

2.6.1. Lemma. *If an arrangement of ovals D is trigonal with respect to an annulus N , then it has either one or three principal ovals. Moreover*

- (1) *non-principal ovals are empty;*
- (2) *a non-principal oval cannot have inward cusps, and may have maximum two outward cusps;*
- (3) *the ovals lying inside the principal oval, Ω , of D after reversion will lie outside the image of Ω , and vice versa, the ones lying outside Ω will lie inside its image after reversion;*
- (4) *if D has three principal ovals, then there is no other ovals, there is no cusps on the ovals, and D as well as its reversion D' form a 3-nest arrangement $1\langle 1 \rangle$. \square*

We say that non-empty real Zariski sextics A and A' are *reversion partners* if (a) $A(\mathbb{R})$ is trigonal with respect to some annulus $N \supset A(\mathbb{R})$ and $A'(\mathbb{R})$ is obtained by reversion of $A(\mathbb{R})$, (b) A and A' are both of the same type, and (c) the signs $o(A)$ and $o(A')$ are opposite.

Note furthermore that the definition of reversion implies that the cusps on the ambient ovals change their shape after reversion: the inward cusps become outward and vice versa. And by contrary, the cusps on the non-principal ovals do not change their shape.

2.6.2. Corollary. *Assume that real Zariski sextics A and A' are reversion partners. Then:*

- (1) *if A has 3-nest code $1\langle 1 \rangle$, then all three ovals are principal and A' has the same code;*
- (2) *if an oval of A has an inward cusp, or more than two outward cusps, then it is principal;*
- (3) *if the simple code of A is $\alpha \sqcup 1\langle \beta \rangle$, $\beta > 0$, then the ambient oval must be principal and A' must have simple code $\beta \sqcup 1\langle \alpha \rangle$;*
- (4) *if the complete code of A is $\alpha_k \sqcup 1_m \langle \beta_n \rangle$, $\beta > 0$, $k, n, m \in \mathbb{Z}$ (zero index here means that it should be dropped), then the complete code of A' is $\beta_n \sqcup 1_{-m} \langle \alpha_k \rangle$. \square*

The rule (4) in Corollary 2.6.2 can be extended to $A(\mathbb{R})$ having only empty ovals, if using 2.6.2(2) we can determine which of the ovals is principal, or if all the ovals look alike. For instance, if the complete code of A is $1 \sqcup 1_n$, where $n < 0$, or $n > 1$, then A' has complete code $1_{-n} \langle 1 \rangle$. If A has code n_1 , then A' has code $1_{-1} \langle (n-1)_1 \rangle$.

Remark. If A has, for instance, code $1 \sqcup 1_1$ then the rules stated above do not give an answer, which of the ovals is principal, and so, one could question if the complete code of a reversion partner of A is determined uniquely by the complete code of A ? Is it possible for A to have several reversion partners? In what follows we will prove that a real Zariski sextic A cannot have more than one reversion partner. For example, the partner for A with the code $1 \sqcup 1_1$ has code $1\langle 1_1 \rangle$, and there is no Zariski sextic with the code $1_{-1} \langle 1 \rangle$.

2.7. The relation between the topology of cubic surfaces and their Zariski sextics. Here, we consider a real nonsingular cubic surface X and one of its real Zariski sextics, A . Recall that the real locus $X(\mathbb{R})$ of X may consist of two components, one homeomorphic to S^2 and another to $P^2(\mathbb{R})$. Otherwise, $X(\mathbb{R})$ is homeomorphic to $P^2(\mathbb{R})$ with $h \leq 3$ handles. In particular, $X(\mathbb{R})$ is determined, up to homeomorphism, by its Euler characteristic $\chi(X(\mathbb{R})) = 1 - 2h$, or equivalently, by $h \in \{-1, 0, 1, 2, 3\}$, where $h = -1$ corresponds to the case of disconnected $X(\mathbb{R})$.

2.7.1. Lemma. *Assume that A has code $\alpha \sqcup 1\langle \beta \rangle$, so that $d(A) = 4 - \alpha - \beta$. Then*

$$\chi(X(\mathbb{R})) = \begin{cases} 3 + 2(\alpha - \beta) - 2\nu_r = 4\alpha + 2d(A) + 2\nu_i - 11 & \text{if } o(A) = -, \\ 1 + 2(\beta - \alpha) - 2\nu_r = 4\beta + 2d(A) + 2\nu_i - 13 & \text{if } o(A) = +. \end{cases}$$

In the case of null-code, $\chi(X(\mathbb{R}))$ equals 1 if $o(A) = -$ and 3 if $o(A) = +$.

In the case of 3-nest code, $\chi(X(\mathbb{R}))$ equals 3 if $o(A) = -$ and 1 if $o(A) = +$.

Proof. As it follows from Corollary 2.1.2, $\chi(X(\mathbb{R})) = 3\chi(\mathcal{A}_-) + \chi(\mathcal{A}_+) - 2\nu_r = 1 + 2\chi(\mathcal{A}_-) - 2\nu_r$. \square

2.7.2. Corollary. *If A has code $\alpha \sqcup 1\langle\beta\rangle$, then*

$$h(X) = \begin{cases} \nu_r + \beta - \alpha - 1 & = 6 - (2\alpha + d(A) + \nu_i) & \text{if } o(A) = -, \\ \nu_r + \alpha - \beta & = 7 - (2\beta + d(A) + \nu_i) & \text{if } o(A) = +. \end{cases}$$

If A has null-code, then $h(X) = 0$ if $o(A) = -$, and $h(X) = -1$ if $o(A) = +$.

If A has 3-nest code, then $h(X) = -1$ if $o(A) = -$, and $h(X) = 0$ if $o(A) = +$. \square

The following observation is a kind of refinement of Lemma 2.3.6.

2.7.3. Lemma. *If the disc bounded by a smooth empty oval of $A(\mathbb{R})$ lies in \mathcal{A}_- , then $h(X) = -1$. In particular, for any A with code $\alpha \sqcup 1\langle\beta\rangle$, $\beta \geq 0$,*

- (1) *if either some external oval or the ambient oval has an outward cusp and one of the external ovals is smooth, then $\nu_r = \alpha - \beta$;*
- (2) *if either an internal oval has an outward cusp, or the ambient oval has an inward cusp and one of the internal ovals is smooth, then $\nu_r = \beta - \alpha - 1$.*

Proof. Smoothness of an oval bounding a disc in \mathcal{A}_- , over which the projection $X(\mathbb{R}) \rightarrow P(\mathbb{R})$ is three-to-one, implies that $X(\mathbb{R})$ must contain a spherical component projecting to this disc, and thus, $h(X) = -1$. Assumption (1), as well as (2), guarantees that the smooth oval bounds a disc component of \mathcal{A}_- , and the conclusion $h(X) = -1$ is reformulated via Corollary 2.7.2. \square

2.7.4. Corollary. *If all the ovals of $A(\mathbb{R})$ are empty and $o(A) = -$, then either (a) all ovals have outward cusps, or (b) one oval is smooth and each of the others has precisely two outward cusps.*

Proof. Since $o(A) = -$, the cusps are outward. By Lemma 2.3.6 there cannot be more than one smooth oval, and letting $\beta = 0$ in Lemma 2.7.3(1), we see that in the presence of a smooth oval the others cannot have more than one pair of cusps. \square

2.8. Relation to the double covering cuspidal K3-surface Y . By taking double covering $\pi_Y: Y \rightarrow P^2$ ramified along Zariski sextic A , we obtain a K3-surface Y which has six cuspidal singular points. There exist two liftings of the complex conjugation in P^2 to an involution in Y ; they differ by the deck transformation of the covering and both are anti-holomorphic. Let us choose and denote by $\text{conj}_Y: Y \rightarrow Y$ the one whose real locus, $Y(\mathbb{R}) = \text{Fix}(\text{conj}_Y)$, is projected by π_Y to \mathcal{A}_n . We call such conj_Y the *Möbius involution*.

The group $H_2(Y)/\text{Tors}$ is a free abelian group of rank $b_2(X) = 22 - 12 = 10$. We consider the involution $(\text{conj}_Y)_*$ induced in $H_2(Y)/\text{Tors}$ and denote by r_{\pm} the ranks of the ± 1 -eigengroups, $\{x \in H_2(Y)/\text{Tors} \mid (\text{conj}_Y)_*(x) = \pm x\}$.

2.8.1. Lemma. *For any real Zariski sextic A we have $\chi(\mathcal{A}_-) = 1 + \frac{r_+ - r_-}{2}$. Specifically, if A has code $\alpha \sqcup 1\langle\beta\rangle$, $\alpha, \beta \geq 0$, so that $d(A) = 4 - (\alpha + \beta)$, then*

$$\begin{aligned} r_+ &= (\beta - \alpha) + 4 = 2\beta + d(A), \\ r_- &= (\alpha - \beta) + 6 = 2\alpha + d(A) + 2. \end{aligned}$$

If A has null code, then $r_+ = r_- = d(A) = 5$.

If A has 3-nest code, then $r_+ = d(A) + 2 = 4$ and $r_- = 6$.

Proof. We have obviously $r_+ + r_- = b_2(X) = 10$, and the Lefschetz fixed-point formula applied to conj_Y yields $r_+ - r_- = \chi(Y(\mathbb{R})) - 2 = 2(\chi(\mathcal{A}_-) - 1)$, where $\chi(\mathcal{A}_-) = \beta - \alpha$ in the case of code $\alpha \sqcup 1\langle\beta\rangle$. For the null-code and 3-nest code one has $\chi(\mathcal{A}_-) = \chi(\mathbb{R}P^2) = 1$ and $\chi(\mathcal{A}_-) = 0$ respectively. \square

2.8.2. Corollary. *For any real Zariski sextic the following three conditions are equivalent:*

- (1) *the sextic has null-code;*
- (2) $r_+ = d(A) = 5$;
- (3) $d(A) > r_- - 2$. \square

Next, we obtain the following relation between $Y(\mathbb{R})$ and $X(\mathbb{R})$, or more precisely, between r_\pm and $h = \frac{1 - \chi(X(\mathbb{R}))}{2}$.

2.8.3. Corollary. *For any real Zariski sextic A with code $\alpha \sqcup 1\langle\beta\rangle$ the following identities hold:*

$$\begin{aligned} \text{if } o(A) = - \text{ then } & \begin{cases} r_+ = \nu_i + 2 + h, \\ r_- = (4 - \nu_i) + 2 + (2 - h); \end{cases} \\ \text{if } o(A) = + \text{ then } & \begin{cases} r_- = \nu_i + 2 + (h + 1), \\ r_+ = (4 - \nu_i) + 2 + (1 - h). \end{cases} \end{aligned}$$

Proof. It follows from Lemma 2.8.1 and Corollary 2.7.2. \square

2.9. Deformation classification statement. By the *ID* of a real Zariski sextic A we mean the triple $\text{ID}(A) = (\text{complete code of } A, \text{type of } A, o(A))$, i.e., its complete code enhanced with two additional bits of information: the type (I or II), and the sign (+ or -).

Let us recall that two real Zariski sextics are said to be *equivalent up to equivariant deformation*, or shortly *belonging to the same deformation class* if and only if they belong to the same component of the space of real Zariski sextics.

Table 1A. Zariski sextics without a partner.

| | simple codes | $\nu_r(A)$ | $o(A)$ | complete codes | types |
|---|----------------------|------------|--------|---------------------------------|-------|
| 1 | $1\langle 4 \rangle$ | 0 | - | $1\langle 4 \rangle$ | I |
| 2 | $1\langle 3 \rangle$ | 1 | - | $1_1\langle 3 \rangle$ | II |
| 3 | $1\langle 2 \rangle$ | 1 | + | $1\langle 1_1 \sqcup 1 \rangle$ | I |
| 4 | $1\langle 2 \rangle$ | 2 | - | $1_2\langle 2 \rangle$ | II |
| 5 | $1\langle 1 \rangle$ | 3 | - | $1_3\langle 1 \rangle$ | II |
| 6 | $1\langle 1 \rangle$ | 0 | + | $1\langle 1 \rangle$ | II |

2.9.1. Theorem. *Each real Zariski sextic is determined up to equisingular deformation by its ID. The list of IDs of real Zariski sextics is given in Tables 1A-C.*

The proof of Theorem 2.9.1 is one of our main goals. It is given in the very end of the paper, see Section 8.6.

3. PRELIMINARIES ON LATTICE THEORY

3.1. Even lattices and their discriminants. By a *lattice* we mean a free abelian group of finite rank endowed with a *non-degenerate* bilinear symmetric \mathbb{Z} -valued pairing, called also the *inner product of a lattice*.

ZARISKI SEXTICS WITH A PARTNER

Table 1B. The case of $o(A) = -$.

Table 1C. The case of $o(A) = +$.

| | simple codes | $\nu_r(A)$ | complete codes | types | simple codes | $\nu_r(A)$ | complete codes | types |
|----|---------------------------------------|------------|---------------------------------------|-----------|---------------------------------------|------------|---------------------------------------|-----------|
| 1 | $3 \sqcup 1\langle 1 \rangle$ | 3 | $3_1 \sqcup 1\langle 1 \rangle$ | <i>I</i> | $1 \sqcup 1\langle 3 \rangle$ | 3 | $1 \sqcup 1\langle 3_1 \rangle$ | <i>I</i> |
| 2 | $2 \sqcup 1\langle 2 \rangle$ | 2 | $2_1 \sqcup 1\langle 2 \rangle$ | <i>I</i> | $2 \sqcup 1\langle 2 \rangle$ | 2 | $2 \sqcup 1\langle 2_1 \rangle$ | <i>I</i> |
| 3 | $1 \sqcup 1\langle 3 \rangle$ | 1 | $1_1 \sqcup 1\langle 3 \rangle$ | <i>I</i> | $3 \sqcup 1\langle 1 \rangle$ | 1 | $3 \sqcup 1\langle 1_1 \rangle$ | <i>I</i> |
| 4 | 4 | 3 | $3_1 \sqcup 1$ | <i>II</i> | $1\langle 3 \rangle$ | 3 | $1\langle 3_1 \rangle$ | <i>II</i> |
| 5 | $2 \sqcup 1\langle 1 \rangle$ | 3 | $2_1 \sqcup 1_1\langle 1 \rangle$ | <i>II</i> | $1 \sqcup 1\langle 2 \rangle$ | 3 | $1 \sqcup 1_{-1}\langle 2_1 \rangle$ | <i>II</i> |
| 6 | $2 \sqcup 1\langle 1 \rangle$ | 2 | $2_1 \sqcup 1\langle 1 \rangle$ | <i>II</i> | $1 \sqcup 1\langle 2 \rangle$ | 2 | $1 \sqcup 1\langle 2_1 \rangle$ | <i>II</i> |
| 7 | $1 \sqcup 1\langle 2 \rangle$ | 2 | $1_1 \sqcup 1_1\langle 2 \rangle$ | <i>II</i> | $2 \sqcup 1\langle 1 \rangle$ | 2 | $2 \sqcup 1_{-1}\langle 1_1 \rangle$ | <i>II</i> |
| 8 | $1 \sqcup 1\langle 2 \rangle$ | 1 | $1_1 \sqcup 1\langle 2 \rangle$ | <i>II</i> | $2 \sqcup 1\langle 1 \rangle$ | 1 | $2 \sqcup 1\langle 1_1 \rangle$ | <i>II</i> |
| 9 | $1\langle 3 \rangle$ | 0 | $1\langle 3 \rangle$ | <i>II</i> | 4 | 0 | 4 | <i>II</i> |
| 10 | 3 | 3 | 3_1 | <i>I</i> | $1\langle 2 \rangle$ | 3 | $1_{-1}\langle 2_1 \rangle$ | <i>I</i> |
| 11 | 3 | 3 | 3_1 | <i>II</i> | $1\langle 2 \rangle$ | 3 | $1_{-1}\langle 2_1 \rangle$ | <i>II</i> |
| 12 | 3 | 2 | $2_1 \sqcup 1$ | <i>II</i> | $1\langle 2 \rangle$ | 2 | $1\langle 2_1 \rangle$ | <i>II</i> |
| 13 | $1 \sqcup 1\langle 1 \rangle$ | 3 | $1_1 \sqcup 1_2\langle 1 \rangle$ | <i>II</i> | $1 \sqcup 1\langle 1 \rangle$ | 3 | $1 \sqcup 1_{-2}\langle 1_1 \rangle$ | <i>II</i> |
| 14 | $1 \sqcup 1\langle 1 \rangle$ | 2 | $1_1 \sqcup 1_1\langle 1 \rangle$ | <i>I</i> | $1 \sqcup 1\langle 1 \rangle$ | 2 | $1 \sqcup 1_{-1}\langle 1_1 \rangle$ | <i>I</i> |
| 15 | $1 \sqcup 1\langle 1 \rangle$ | 2 | $1_1 \sqcup 1_1\langle 1 \rangle$ | <i>II</i> | $1 \sqcup 1\langle 1 \rangle$ | 2 | $1 \sqcup 1_{-1}\langle 1_1 \rangle$ | <i>II</i> |
| 16 | $1 \sqcup 1\langle 1 \rangle$ | 1 | $1_1 \sqcup 1\langle 1 \rangle$ | <i>II</i> | $1 \sqcup 1\langle 1 \rangle$ | 1 | $1 \sqcup 1\langle 1_1 \rangle$ | <i>II</i> |
| 17 | $1\langle 1\langle 1 \rangle \rangle$ | 0 | $1\langle 1\langle 1 \rangle \rangle$ | <i>I</i> | $1\langle 1\langle 1 \rangle \rangle$ | 0 | $1\langle 1\langle 1 \rangle \rangle$ | <i>I</i> |
| 18 | $1\langle 2 \rangle$ | 1 | $1_1\langle 2 \rangle$ | <i>I</i> | 3 | 1 | $1_{-1} \sqcup 2$ | <i>I</i> |
| 19 | $1\langle 2 \rangle$ | 1 | $1_1\langle 2 \rangle$ | <i>II</i> | 3 | 1 | $1_{-1} \sqcup 2$ | <i>II</i> |
| 20 | $1\langle 2 \rangle$ | 0 | $1\langle 2 \rangle$ | <i>II</i> | 3 | 0 | 3 | <i>II</i> |
| 21 | 2 | 3 | $1_2 \sqcup 1_1$ | <i>II</i> | $1\langle 1 \rangle$ | 3 | $1_{-2}\langle 1_1 \rangle$ | <i>II</i> |
| 22 | 2 | 2 | 2_1 | <i>II</i> | $1\langle 1 \rangle$ | 2 | $1_{-1}\langle 1_1 \rangle$ | <i>II</i> |
| 23 | 2 | 1 | $1_1 \sqcup 1$ | <i>II</i> | $1\langle 1 \rangle$ | 1 | $1\langle 1_1 \rangle$ | <i>II</i> |
| 24 | $1\langle 1 \rangle$ | 2 | $1_2\langle 1 \rangle$ | <i>II</i> | 2 | 2 | $1_{-2} \sqcup 1$ | <i>II</i> |
| 25 | $1\langle 1 \rangle$ | 1 | $1_1\langle 1 \rangle$ | <i>II</i> | 2 | 1 | $1_{-1} \sqcup 1$ | <i>II</i> |
| 26 | $1\langle 1 \rangle$ | 0 | $1\langle 1 \rangle$ | <i>II</i> | 2 | 0 | 2 | <i>II</i> |
| 27 | 1 | 3 | 1_3 | <i>II</i> | 1 | 3 | 1_{-3} | <i>II</i> |
| 28 | 1 | 2 | 1_2 | <i>II</i> | 1 | 2 | 1_{-2} | <i>II</i> |
| 29 | 1 | 1 | 1_1 | <i>II</i> | 1 | 1 | 1_{-1} | <i>II</i> |
| 30 | 1 | 0 | 1 | <i>II</i> | 1 | 0 | 1 | <i>II</i> |
| 31 | 0 | 0 | 0 | <i>II</i> | 0 | 0 | 0 | <i>II</i> |

We denote by $\langle n \rangle$, $n \in \mathbb{Z} \setminus \{0\}$, the lattice of rank 1 whose generator has square n , by \mathbb{U} the lattice of rank 2 defined by matrix $\begin{bmatrix} 0 & 1 \\ 1 & 0 \end{bmatrix}$, and by \mathbb{A}_n ($n \geq 1$), \mathbb{D}_n ($n \geq 4$), \mathbb{E}_n ($6 \leq n \leq 8$) the lattices generated by the corresponding *negative definite* root systems. Given two lattices L and M , we denote by $L + M$ their direct sum. Notation nL , $n \geq 1$, stands for the direct sum of n copies of L , while $L(n)$, $n \in \mathbb{Z} \setminus \{0\}$, denotes the result of rescaling the lattice L with a scale factor n , i.e., $L(n)$ as a group coincides with L but the product of elements in $L(n)$ is n times greater than in L .

In this paper, we deal generally with *even lattices*, unless it is stated otherwise (although some of the techniques that we use or develop can be adapted to the case of odd lattices as well). Recall that a lattice L is called even, if x^2 is even for any $x \in L$. When a lattice L is equipped with a lattice involution $c: L \rightarrow L$, we introduce a *c-twisted inner product* $\langle x, y \rangle_c = x \cdot c(y)$, which is obviously bilinear, symmetric and non-degenerate, and say that the pair (L, c) is of *type I* if the c -twisted product is even, and of *type II* otherwise.

Given a lattice, L , we denote by $\text{discr } L$ its (finite abelian) discriminant group, L^*/L , where $L^* = \text{Hom}(L, \mathbb{Z})$ is identified with a subgroup in $L \otimes \mathbb{Q}$ by means of the lattice pairing. The group $\text{discr } L$ is endowed with the nondegenerate \mathbb{Q}/\mathbb{Z} -valued inner product $[x][y] = xy \pmod{\mathbb{Z}}$, where $x, y \in L^*$ and $[x], [y]$ stand for the cosets. Our assumption that the lattice L is even endows $\text{discr } L$ with a $\mathbb{Q}/2\mathbb{Z}$ -valued quadratic refinement of the inner product. This refinement, $\mathfrak{q}_L: \text{discr } L \rightarrow \mathbb{Q}/2\mathbb{Z}$, is given by $\mathfrak{q}_L([x]) = x^2 \pmod{2\mathbb{Z}}$; it is called the *discriminant form* of L . The relation $\mathfrak{q}_L([x] + [y]) = \mathfrak{q}_L([x]) + \mathfrak{q}_L([y]) + 2[x][y]$ implies that \mathfrak{q}_L determines the inner product of $\text{discr } L$.

The pair $(\text{discr } L, \mathfrak{q}_L)$ is called the *discriminant* of L , and when it does not lead to a confusion is denoted simply by $\text{discr } L$ or \mathfrak{q}_L .

3.2. Groups with inner products and quadratic refinements. A finite abelian group G endowed with a non-degenerate symmetric bilinear form $G \times G \rightarrow \mathbb{Q}/\mathbb{Z}$ will be called a *finite inner product group*. We denote by ab the inner product of elements $a, b \in G$ and use notation $\langle \frac{m}{n} \rangle$ (with coprime m and n) for a finite inner product cyclic group \mathbb{Z}/n that has $a^2 = \frac{m}{n} \in \mathbb{Q}/\mathbb{Z}$ for one of generators $a \in \mathbb{Z}/n$.

If a finite inner product group G is endowed additionally with a *quadratic refinement*, $\mathfrak{q}: G \rightarrow \mathbb{Q}/2\mathbb{Z}$, then G will be called an *enhanced group*. By definition, \mathfrak{q} must be related to the inner product as follows: for all $a, b \in G$, $n \in \mathbb{Z}$,

- (1) $\mathfrak{q}(a + b) = \mathfrak{q}(a) + \mathfrak{q}(b) + 2ab$,
- (2) $\mathfrak{q}(na) = n^2\mathfrak{q}(a)$.

These relations imply $\mathfrak{q}(-a) = \mathfrak{q}(a)$, $\mathfrak{q}(a) = a^2 \pmod{\mathbb{Z}}$, and $\mathfrak{q}(2a) = 4a^2 \pmod{2\mathbb{Z}}$ (note that $4a^2$ is well-defined modulo 4 and, thus, modulo 2). The latter relation shows that $\mathfrak{q}(a)$ is defined uniquely by the inner product as soon as a is divisible by 2. In the context of enhanced groups, notation $\langle \frac{m}{n} \rangle$ (with coprime m and n) has a meaning that $\mathfrak{q}(a) = \frac{m}{n} \in \mathbb{Q}/2\mathbb{Z}$ for a generator $a \in \mathbb{Z}/n$. Note that in this case either m or n must be even, since $\mathfrak{q}((n+1)a) = \mathfrak{q}(a)$ if and only if $\frac{m}{n}((n+1)^2 - 1)$ is even.

3.2.1. Lemma. *Any finite inner product group G of odd order has a canonical quadratic refinement and, thus, is an enhanced group.*

Proof. Let $\mathfrak{q}(a) = 4(\frac{a}{2})^2 \pmod{2\mathbb{Z}}$, then all the required properties are satisfied. \square

3.2.2. Example. A finite inner product group $\langle \frac{1}{3} \rangle$ being enhanced takes notation $\langle -\frac{2}{3} \rangle$ according to our conventions. An enhanced group $\langle \frac{1}{6} \rangle$ splits into a direct (orthogonal) sum $\langle -\frac{1}{2} \rangle + \langle \frac{2}{3} \rangle$.

In general, the set of quadratic refinements of a given inner product in a group G form an affine space over $\text{Hom}(G, \mathbb{Z}/2\mathbb{Z})$.

We say that a subgroup $K \subset G$ of a finite inner product group G is *non-degenerate* if its kernel $\{x \in K \mid xK = 0\}$ is trivial. It is straightforward to check the following.

3.2.3. Lemma. *If K is a non-degenerate subgroup of a finite inner product group G , then K splits out as a direct summand, $G = K + K^\perp$. \square*

3.3. The p -components. By a *p -group*, where p is prime, we mean a finite abelian group G , such that the order, $\text{ord}(x)$, of any element $x \in G$ is a power of p . Note that any p -group G can be presented as a direct sum of cyclic subgroups of the form \mathbb{Z}/p^k , $k \geq 1$, and that the number

of summands is an invariant of G independent of a decomposition; it is called the *rank of G* . If $\text{ord}(x) = p$ for all non-identity $x \in G$, then G is called an *elementary p -group*; such a group G can be viewed as a vector space over \mathbb{Z}/p .

Any finite abelian group G splits into a direct sum of its maximal p -subgroups G_p called *prime components*, or *p -components* of G . The p -primary component of G is non-trivial if and only if p divides the order of G and coincides with the subgroup formed in G by elements whose order is a power of p . With respect to any inner product in G the subgroups G_p must be orthogonal, which reduces studying of inner products to the case of p -groups.

3.3.1. Lemma. *Assume that G is a finite inner product group (for instance, an enhanced group).*

- (1) *If $x \in G$ has order n , then $x^2 \in \frac{1}{n}\mathbb{Z}/\mathbb{Z}$ (respectively, $\mathfrak{q}(x) \in \frac{1}{n}\mathbb{Z}/2\mathbb{Z}$).*
- (2) *Any two prime components, G_{p_1} and G_{p_2} , $p_1 \neq p_2$, are orthogonal with respect to the inner product in G .*

Proof. If $x, y \in \text{discr } L$ and x has order n , then $xy \in \frac{1}{n}\mathbb{Z}/\mathbb{Z}$ and x is orthogonal to ny , since $nxy = x(ny) = (nx)y = 0 \in \mathbb{Q}/\mathbb{Z}$. This implies both (1) and (2), since $\mathfrak{q}(x) = x^2 \pmod{\mathbb{Z}}$. \square

3.4. The p -ranks of lattices. In a particular case of a lattice L (which can be odd here) and $G = \text{discr } L$ (viewed here only as a group), we call the prime components G_p the *discriminant p -components* and their ranks the *p -ranks of L* . We denote them $\text{discr}_p L$ and $r_p = r_p(L)$, respectively. The primes p for which $\text{discr}_p L \neq 0$ (i.e., the prime divisors of $|\text{discr } L|$) are called the *discriminant factors of L* . A discriminant factor p is said to be *elementary* if $\text{discr}_p L$ is an elementary p -group, we say also that L is *p -elementary* in this case. A lattice L is said to be *divisible by p* if xy is divisible by p for all $x, y \in L$, or equivalently, if $L' = L(\frac{1}{p})$ is a lattice.

Consider an endomorphism $m_p: \text{discr } L \rightarrow \text{discr } L$, $m_p(x) = px$, then its kernel $K_p \subset \text{discr } L$ is an elementary p -group of rank r_p . Let $L_p^* = \psi^{-1}(K_p) \subset L^*$ be the pull-back with respect to the projection $\psi: L^* \rightarrow \text{discr } L = L^*/L$.

3.4.1. Proposition. *For any lattice L and prime p , the p -rank r_p of L is not greater than the rank r of L . Moreover, L is divisible by p if and only if $r_p = r$. In the latter case the following properties hold:*

- (1) *there is a canonical exact sequence $0 \rightarrow \text{discr } L' \xrightarrow{f} \text{discr } L \rightarrow L^*/pL^* \rightarrow 0$, where $L^*/pL^* = (\mathbb{Z}/p)^r$, and the restriction of f yields a group isomorphism $\text{discr}_q L' = \text{discr}_q L$ for any prime $q \neq p$, as well as an isomorphism between $\text{discr}_p L'$ and the subgroup $p \text{discr}_p L \subset \text{discr}_p L$;*
- (2) *the group isomorphism $\text{discr } L' \rightarrow f(\text{discr } L') \subset \text{discr } L$ identifies the discriminant inner product in $\text{discr } L$ restricted to $f(\text{discr } L')$ with the discriminant inner product in $\text{discr } L'$ multiplied by p , and if L' is even, then $\mathfrak{q}_L|_{f(\text{discr } L')}$ is identified with $p\mathfrak{q}_{L'}$.*

Proof. Note that $K_p = (\mathbb{Z}/p)^{r_p} \subset \text{discr } L$ is the maximal subgroup of exponent p in $\text{discr}_p L$ (and thus, in $\text{discr } L$). As it follows from definition, $pL_p^* \subset L$, and thus,

$$K_p = L_p^*/L \subset L_p^*/pL_p^*,$$

where the latter group is isomorphic to $(\mathbb{Z}/p)^r$, since L_p^* is a free abelian group of rank r (as it contains L). Thus, $r_p \leq r$. In the case of equality $r_p = r$, we have $K_p = L_p^*/pL_p^*$, that is $L = pL_p^*$. So, for any $x, y \in L$, $x(\frac{1}{p}y) \in \mathbb{Z}$, since $\frac{1}{p}y \in L_p^* \subset L^*$, and thus, xy is divisible by p , and so L is divisible by p . Conversely, if L is divisible by p , then $\frac{x}{p} \in L_p^*$ for any $x \in L$, and so $L = pL_p^*$ and $K_p = L_p^*/pL_p^*$ has rank $r_p = r$.

The exact sequence in (1), with its properties, follow from the observation that under our identification of L' with L as a group, the dual $(L')^*$ of L' is identified with pL^* . \square

Remark. Given a free abelian group M of rank m , and its subgroup $L \subset M$ of the same rank, one can find a basis e_1, \dots, e_m of M , such that L is spanned by some multiples $k_1 e_1, \dots, k_m e_m$, $k_i \geq 1$, and k_i divides k_{i+1} for $i = 1, \dots, m-1$. This yields a direct sum decomposition $M/L = \mathbb{Z}/k_1 + \dots + \mathbb{Z}/k_m$. If we apply it to $L \subset L^*$, then we get another proof of Proposition 3.4.1. \square

For any lattice L and prime p consider $L_{(p)} = \{x \in L \mid xL = 0 \pmod{p}\}$.

3.4.2. Proposition. *Assume that L has rank r and discriminant p -rank r_p . Then:*

- (1) $L_{(p)} = pL_p^*$;
- (2) $r(L_{(p)}) = r_p(L_{(p)}) = r$;
- (3) $L/L_{(p)} = (\mathbb{Z}/p)^{r-r_p}$;
- (4) *if the p -group $\text{discr}_p L$ is elementary, then $\text{discr}_p M$ for the lattice $M = L_{(p)}(\frac{1}{p})$ is also elementary and has p -rank $r_p(M) = r - r_p$.*

Proof. Both lattices in (1) coincide with $L \cap pL^*$, as it follows immediately from their definitions. This gives (1) and divisibility of $L_{(p)}$ by p , and, thus, (2) as a consequence of Proposition 3.4.1. The group $L/L_{(p)}$ is the quotient of L_p^*/pL_p^* by L_p^*/L , which are elementary p -groups of ranks r and r_p respectively (see the proof of Proposition 3.4.1), this yields (3).

If $\text{discr}_p L$ is elementary, then $\text{discr}_p L = L_p^*/L$ and, in particular, the p -rank of L^*/L_p^* is zero. On the other hand $\text{discr} M = (L_p^*)^*/(pL_p^*)$ and $(L_p^*)^*/L \cong L^*/L_p^*$, so that (4) follows from (1), (3), and $(L_p^*)^* \supset L \supset pL_p^*$. \square

3.4.3. Lemma. *For every even lattice L , we have $r_2(L) = r(L) \pmod{2}$.*

Proof. In accordance with the definition of the 2-rank, r_2 is equal to the rank of the subgroup of $\text{discr} L$ that is formed by elements of order 2. In its turn, the rank of this subgroup is equal to the rank of $\text{discr}(L)/2 \text{discr}(L)$, and thus to the rank of the radical of the mod 2 reduction of L (as a quadratic space). This reduction is even, since L is even. Therefore, $r(L) - r_2(L)$ as the rank of a non degenerate even $\mathbb{Z}/2$ -valued form is even. \square

3.5. The Brown invariant. As is known, for any enhanced group (G, \mathfrak{q}) , the Gaussian sum $\mathcal{G}(\mathfrak{q}) = \sum_{x \in G} e^{\pi i \mathfrak{q}(x)}$ has absolute value $\sqrt{|G|}$, whereas $\frac{\mathcal{G}(\mathfrak{q})}{\sqrt{|G|}}$ belongs to the group μ_8 of eight's roots of 1. In modern terminology one speaks on the (generalized) *Brown invariant*, $\text{Br}(\mathfrak{q}) \in \mathbb{Z}/8 \cong \mu_8$. This Gaussian sum appears in Van der Blij's famous formula that relates, in the case of even lattices and their discriminants, the argument of $\mathcal{G}(\mathfrak{q})$ with the signature of the lattice.

3.5.1. Theorem. (*Van der Blij [VdB]*) *If L is an even lattice, then $\text{Br}(\mathfrak{q}_L)$ is equal to the mod 8 residue of the signature $\sigma(L)$ of L . \square*

Note that the definition via Gauss sums immediately implies additivity,

$$\text{Br}(\mathfrak{q}_1 \oplus \mathfrak{q}_2) = \text{Br}(\mathfrak{q}_1) + \text{Br}(\mathfrak{q}_2).$$

Speaking on even lattices L , we let $\text{Br}(L) = \text{Br}(\mathfrak{q}_L)$ and $\text{Br}_p(L) = \text{Br}(\mathfrak{q}_L|_{\text{discr}_p(L)})$. Then Lemma 3.3.1 and the above additivity formula imply the following statement.

3.5.2. Proposition. *For any even lattice L , we have $\text{Br}(L) = \sum_{\text{prime } p} \text{Br}_p(L)$. \square*

3.6. Elementary 2-groups with a quadratic refinement. Assume that G is an elementary 2-group endowed with an inner product and its quadratic refinement \mathfrak{q} . The inner product is said to be *even* if $x^2 = 0$ for all $x \in G$, or in terms of \mathfrak{q} , if values of $\mathfrak{q}(x)$ are integer (and thus, $\mathfrak{q}(x) \in \mathbb{Z}/2\mathbb{Z}$). Otherwise, the inner product is called *odd*. We encode this parity by putting $\delta_2(\mathfrak{q}) = 0$ in the even case, and $\delta_2(\mathfrak{q}) = 1$ otherwise. For each 2-elementary lattice L , we define its *discriminant parity* $\delta_2(L) \in \mathbb{Z}/2$ by letting $\delta_2(L) = \delta_2(\mathfrak{q}_L)$.

3.6.1. Example. The group $\mathbb{Z}/2 = \{[0], [1]\}$ has a unique inner product, $[1][1] = \frac{1}{2}$, $[*][0] = [0][*] = 0$, but two possible quadratic refinements, $\mathfrak{q}([1]) = \pm\frac{1}{2}$, $\mathfrak{q}([0]) = 0$, denoted following our convention in 3.2 by $\langle \pm\frac{1}{2} \rangle$. Note that an even enhanced 2-group cannot contain $\langle \pm\frac{1}{2} \rangle$ as a direct summand.

Observing that $\text{discr}(\langle \pm 2 \rangle) = \langle \pm\frac{1}{2} \rangle$ we obtain $\delta_2(\langle \pm 2 \rangle) = 1$ and $\text{Br}(\langle \pm 2 \rangle) = \pm 1$.

3.6.2. Example. The discriminant groups of lattices $\mathbb{U}(2)$ and \mathbb{D}_4 are both isomorphic to $G = \mathbb{Z}/2 + \mathbb{Z}/2$, with the inner product $\begin{bmatrix} 0 & \frac{1}{2} \\ \frac{1}{2} & 0 \end{bmatrix}$. The quadratic refinements are $\mathfrak{q}_{\mathbb{U}(2)}(1, 0) = \mathfrak{q}_{\mathbb{U}(2)}(0, 1) = 0$, $\mathfrak{q}_{\mathbb{U}(2)}(1, 1) = 1$, and $\mathfrak{q}_{\mathbb{D}_4}(1, 1) = \mathfrak{q}_{\mathbb{D}_4}(1, 0) = \mathfrak{q}_{\mathbb{D}_4}(0, 1) = 1$. We denote the corresponding enhanced groups by \mathcal{U}_2 and \mathcal{V}_2 respectively. Here we have $\delta_2(\mathbb{U}(2)) = \delta_2(\mathbb{D}_4) = 0$, whereas $\text{Br}(\mathbb{U}(2)) = 0$ but $\text{Br}(\mathbb{D}_4) = 4$.

The following statement is a straightforward consequence of well known "uniqueness" results, see [W1] (cf., [GM]).

3.6.3. Theorem. *Any elementary enhanced 2-group (G, \mathfrak{q}) is characterized up to isomorphism by its rank, the Brown invariant, and the parity. The only non-split enhanced 2-groups are $\langle \pm\frac{1}{2} \rangle$, \mathcal{U}_2 , and \mathcal{V}_2 . Moreover:*

- (1) *If $\delta_2(\mathfrak{q}) = 0$, then $G = a\mathcal{U}_2 + b\mathcal{V}_2$, for some $a, b \geq 0$. In particular, the rank of G is even and $\text{Br}(\mathfrak{q}) = a\text{Br}(\mathcal{U}_2) + b\text{Br}(\mathcal{V}_2) = 4b \pmod{8}$ is divisible by 4.*
- (2) *$a\mathcal{U}_2 + b\mathcal{V}_2$ is isomorphic to $a'\mathcal{U}_2 + b'\mathcal{V}_2$ if and only if $a + b = a' + b'$ and $a = a' \pmod{2}$.*
- (3) *If $\delta_2(\mathfrak{q}) = 1$, then $G = a\langle \frac{1}{2} \rangle + b\langle -\frac{1}{2} \rangle$, for some $a, b \geq 0$, $a + b = r_2$. In particular, $\text{Br}(\mathfrak{q}) = a - b \pmod{8}$.*
- (4) *$a\langle \frac{1}{2} \rangle + b\langle -\frac{1}{2} \rangle$ is isomorphic to $a'\langle \frac{1}{2} \rangle + b'\langle -\frac{1}{2} \rangle$ if and only if $a + b = a' + b'$ and $a = a' \pmod{4}$. \square*

3.6.4. Lemma. *Assume that (G, \mathfrak{q}) is an elementary enhanced 2-group and $v \in G$ such that $\mathfrak{q}(v) \neq 0$. Then:*

- (1) *The orthogonal complement v^\perp is an enhanced subgroup of G .*
- (2) *v^\perp is even if and only if v is the characteristic element of G .*
- (3) *If v is characteristic, then $2\mathfrak{q}(v) \in \mathbb{Z}/4\mathbb{Z}$ equals to the mod 4-residue of $\text{Br}(\mathfrak{q}) \in \mathbb{Z}/8$.*
- (4) *If $\mathfrak{q}(v) = \pm\frac{1}{2}$, then the Brown invariant $\text{Br}\langle v \rangle$ of the subgroup $\langle v \rangle \subset G$ spanned by v is respectively ± 1 .*

Proof. Item (4) is already seen in Example 3.6.1. Item (1) follows from non-degeneracy of $\mathfrak{q}|_{v^\perp}$, which is due to $\mathfrak{q}(v) \neq 0$. Item (2) follows from $\mathfrak{q}(x) = xv \pmod{\mathbb{Z}}$, by the definition of the characteristic element v . To prove item (3) it is sufficient, due to additivity of $\mathfrak{q}(v)$ and Br with respect to the direct sums and the classification given in Theorem 3.6.3, to check the required relation on the four non-split enhanced groups $\langle \frac{1}{2} \rangle$, $\langle -\frac{1}{2} \rangle$, \mathcal{U}_2 , and \mathcal{V}_2 (cf., Examples 3.6.1 and 3.6.2). \square

3.7. Elementary 3-groups with an inner product. The group $G = \mathbb{Z}/3 = \{[0], [1], [2]\}$ admits two different inner product structures, $\langle \frac{1}{3} \rangle$, and $\langle -\frac{1}{3} \rangle$. For the first one, $[1][1] = [2][2] = \frac{1}{3}$, and for the other, $[1][1] = [2][2] = -\frac{1}{3}$. The quadratic refinements take values $\mathfrak{q}([1]) = \mathfrak{q}([2]) = -\frac{2}{3}$ and $\mathfrak{q}([1]) = \mathfrak{q}([2]) = \frac{2}{3}$, respectively (cf. Example 3.2.2); that is why to indicate that we deal with these enhanced structures we use notation $\langle -\frac{2}{3} \rangle$ and $\langle \frac{2}{3} \rangle$.

3.7.1. Example. The discriminant of the lattice \mathbb{A}_2 is $\langle -\frac{2}{3} \rangle$, while $\text{discr} \mathbb{A}_2(-1)$ and $\text{discr} \mathbb{E}_6$ are both isomorphic to $\langle \frac{2}{3} \rangle$. It is easy to check also that $\text{discr}_3 \langle \pm 6 \rangle = \text{discr}_3 \mathbb{A}_2(\pm 2) = \langle \pm \frac{2}{3} \rangle$.

The statements of the following Lemma are well known and can be easily extracted, for example, from [W1].

3.7.2. Lemma.

- (1) Any finite inner product 3-group is isomorphic to $a\langle\frac{2}{3}\rangle + b\langle-\frac{2}{3}\rangle$, for some $a, b \geq 0$, $a + b = r_3$.
- (2) $\text{Br}(a\langle\frac{2}{3}\rangle + b\langle-\frac{2}{3}\rangle) = 2(a - b) \pmod{8}$.
- (3) $a\langle\frac{2}{3}\rangle + b\langle-\frac{2}{3}\rangle$ is isomorphic to $a'\langle\frac{2}{3}\rangle + b'\langle-\frac{2}{3}\rangle$ if and only if $a + b = a' + b'$ and $a = a' \pmod{2}$. In the other words, such inner product groups are isomorphic if and only if their ranks and Brown invariants coincide. \square

3.7.3. Corollary. Finite inner product 3-groups (G, \mathfrak{q}) are characterized up to isomorphism by pairs (a, b) , where $a \in \{0, 1\}$ and $b \geq 0$, such that $G = a\langle\frac{2}{3}\rangle + b\langle-\frac{2}{3}\rangle$. \square

Theorem 3.5.1 and Proposition 3.5.2 with Lemma 3.7.2 imply the following.

3.7.4. Corollary. Assume that a lattice L is even and has only discriminant factors 2 and 3, which are both elementary. Then

$$\text{Br}_2(L) + \text{Br}_3(L) = \sigma(L) \pmod{8},$$

where $\text{Br}_3(L) = 2(a - b) \pmod{8}$ if $\text{discr}_3 L = a\langle\frac{2}{3}\rangle + b\langle-\frac{2}{3}\rangle$. \square

3.8. Extensions of lattices. Consider an even lattice L and its extension $M \supset L$, that is another even lattice of finite index $[M : L]$. By means of the lattice pairing every such M is canonically embedded in $L \otimes \mathbb{Q}$. Furthermore, $L \subset M \subset M^* \subset L^*$ and the subgroup $H = M/L \subset \text{discr } L$ is isotropic, i.e., \mathfrak{q}_L vanishes on H . Conversely, for any isotropic subgroup $H \subset \text{discr } L$, the preimage, $L_H \subset L^*$, of H under the quotient map $L^* \rightarrow L^*/L$ is an even lattice. This implies the following (where (1) is shown in [N1], and (2) follows from the van der Blij Theorem 3.5.1).

3.8.1. Lemma. If M is an extension of L associated with an isotropic subgroup H of $\text{discr } L$, then:

- (1) $\text{discr } M = H^\perp/H$, where $H^\perp = M^*/L = \{x \in \text{discr } L \mid xH = 0\}$ is the orthogonal complement of H ;
- (2) $\text{Br}(L) = \text{Br}(M)$. \square

3.8.2. Lemma. For any even lattice L the correspondence between the isotropic subgroups of $H \subset \text{discr } L$ and the extensions of L is one-to-one, and $\text{discr } L_H = H^\perp/H$. \square

3.8.3. Lemma. Let M_1, M_2 be two extensions of L associated with isotropic subgroups H_1, H_2 of $\text{discr } L$. An automorphism $f: L \rightarrow L$ can be extended to an isomorphism $M_1 \rightarrow M_2$ if and only if the induced automorphism of $\text{discr } L$ maps isomorphically H_1 onto H_2 . \square

3.9. Gluing of lattices. Consider a pair of even lattices L_1, L_2 and subgroups $K_i \subset \text{discr } L_i$, $i = 1, 2$. We say that $\phi: K_1 \rightarrow K_2$ is an anti-isomorphism if it is a group isomorphism such that $\mathfrak{q}_{L_1}(x) = -\mathfrak{q}_{L_2}(\phi(x))$ for all $x \in K_1$. For any such an anti-isomorphism ϕ the graph-subgroup $H_\phi = \{x + \phi(x) \mid x \in K_1\} \subset K_1 + K_2$ is isotropic in $\text{discr}(L_1 + L_2) = \text{discr } L_1 + \text{discr } L_2$ and thus defines an extension of $L_1 + L_2$. We denote this extension by $L_1 +_\phi L_2$ and say that the latter is the result of gluing L_1 with L_2 along ϕ .

Recall that a sublattice $L_1 \subset L$ of a lattice L is called primitive, if the group L/L_1 contains no torsion. It is trivial for instance, that the orthogonal complement $L_2 = L_1^\perp = \{x \in L \mid xy = 0 \text{ for all } y \in L_1\}$ of any sublattice $L_1 \subset L$ is primitive, and primitivity of L_1 is equivalent to that $L_1 = L_2^\perp$. Note that for each $i = 1, 2$ the image of L by the orthogonal projection to $L_i \otimes \mathbb{Q}$ is contained in $L_i^* \subset L \otimes \mathbb{Q}$ and the kernel of the composition $L \rightarrow L_i^* \rightarrow L_i^*/L_i$ is $L_1 + L_2$, so that there appear two well defined induced monomorphisms $p_i: L/(L_1 + L_2) \rightarrow \text{discr } L_i$. Thus, we get the following (see [N1]).

3.9.1. Proposition. *For any gluing $L = L_1 +_\phi L_2$, the lattices L_1 and L_2 are orthogonal complements of each other, and thus primitive, in L . Conversely, if two even sublattices L_1, L_2 of a lattice L are orthogonal complements of each other, then:*

- (1) *they determine canonically subgroups $H_i \subset \text{discr } L_i$, $i = 1, 2$, and an anti-isomorphism $\phi: H_1 \rightarrow H_2$, so that L can be identified with $L_1 +_\phi L_2$ by an isomorphism identical on L_1 and L_2 ;*
- (2) *the above subgroups H_i are nothing but the images, $p_i(L/(L_1 + L_2))$, and $\phi(p_1(x)) = p_2(x)$ for all $x \in L/(L_1 + L_2)$. \square*

3.9.2. Corollary. *Gluing $L = L_1 +_\phi L_2$ is an even lattice with $\text{discr } L = H_\phi^\perp/H_\phi$. \square*

Corollary 3.9.2 together with Lemma 3.2.3 imply the following.

3.9.3. Proposition. *Let $L_1 +_\phi L_2$ be a gluing along $\phi: K_1 \rightarrow K_2$. If $K_i \subset \text{discr } L_i$, $i = 1, 2$, are non-degenerate then $\text{discr}(L_1 +_\phi L_2) = K_1^\perp + K_2^\perp$. \square*

Consider two gluings: $L_1^{(1)} +_{\phi^{(1)}} L_2^{(1)}$ along $\phi^{(1)}: K_1^{(1)} \rightarrow K_2^{(1)}$ and $L_1^{(2)} +_{\phi^{(2)}} L_2^{(2)}$ along $\phi^{(2)}: K_1^{(2)} \rightarrow K_2^{(2)}$. We say that homomorphisms $f_i: L_i^{(1)} \rightarrow L_i^{(2)}$, $i = 1, 2$, are ϕ -compatible, if the induced homomorphisms $f_i^{\text{discr}}: \text{discr } L_i^{(1)} \rightarrow \text{discr } L_i^{(2)}$ restricted to $K_i^{(j)}$ commute with $\phi^{(j)}$:

$$\begin{array}{ccc} K_1^{(1)} & \xrightarrow{f_1^{\text{discr}}} & K_1^{(2)} \\ \downarrow \phi^{(1)} & & \downarrow \phi^{(2)} \\ K_2^{(1)} & \xrightarrow{f_2^{\text{discr}}} & K_2^{(2)}. \end{array}$$

Lemma 3.8.3 immediately implies the following.

3.9.4. Lemma. *Homomorphisms (respectively, isomorphisms) $f_i: L_i^{(1)} \rightarrow L_i^{(2)}$, $i = 1, 2$, can be extended to a homomorphism (respectively, an isomorphism) $L_1^{(1)} +_{\phi^{(1)}} L_2^{(1)} \rightarrow L_1^{(2)} +_{\phi^{(2)}} L_2^{(2)}$ if and only if f_i are ϕ -compatible. \square*

3.10. The orthogonal complement of ± 2 -elements. Primitive lattice elements $v \in L$ with $v^2 = n$ are called *n-elements*. For $n \neq 0$, the sublattice $\mathbb{Z}v$ generated by such a v is isomorphic to $\langle n \rangle$ and its orthogonal complement is denoted by v^\perp or L^v .

For a given n -element v one has $L = \langle n \rangle +_\phi L^v$ with $\phi: K_v \rightarrow K^v$, $K_v \subset \text{discr}\langle n \rangle$ and $K^v \subset \text{discr } L^v$. If $n = \pm 2$, there are two cases: both K_v and K^v are trivial, or $K_v = \text{discr}\langle \pm 2 \rangle = \langle \pm \frac{1}{2} \rangle$ and $K^v = \langle \mp \frac{1}{2} \rangle$. We say that v is *even* in the first case, and that v is *odd* in the second.

3.10.1. Lemma. *For any ± 2 -element $v \in L$ the conditions below are equivalent:*

- (1) *v is even,*
- (2) *$\text{discr } L = \langle \pm \frac{1}{2} \rangle + \text{discr } L^v$,*
- (3) *$L = \mathbb{Z}v + L^v$,*
- (4) *the product vx is even for all $x \in L$,*
- (5) *$\frac{v}{2} \in L \otimes \mathbb{Q}$ lies in L^* and its coset $[\frac{v}{2}]$ is a non-trivial element of $\text{discr } L$.*

Proof. Equivalences (1) \leftrightarrow (2) \leftrightarrow (3) and (4) \leftrightarrow (5) are evident. The remaining equivalence follows from the orthogonal projection formula $\text{proj}_v x = \frac{vx}{v^2}v$. \square

Even ± 2 -elements are subdivided into two species: *ordinary even elements* and *Wu elements*. By definition, an even element v is a Wu element if $[\frac{v}{2}]$ is the *characteristic element* of $\text{discr}_2 L$, i.e., $\mathfrak{q}_L(x) = x[\frac{v}{2}] \pmod{\mathbb{Z}}$ for all $x \in \text{discr}_2 L$; otherwise v is ordinary.

3.10.2. Lemma. *An even ± 2 -element $v \in L$ is a Wu element if and only if the complementary discriminant $\text{discr } L^v$ is even, i.e., $\mathfrak{q}_L(x) \in \mathbb{Z}/2\mathbb{Z} \subset \mathbb{Q}/2\mathbb{Z}$ for all $x \in \text{discr } L^v$.*

Proof. Follows from Lemma 3.10.1(3). \square

3.10.3. Lemma. *For any odd ± 2 -element $v \in L$, the complementary discriminant $\text{discr } L^v$ is isomorphic to $\text{discr } L + \langle \mp \frac{1}{2} \rangle$.*

Proof. Since $K^v = \langle \mp \frac{1}{2} \rangle$ is non-degenerate, it splits off as a direct summand of $\text{discr } L^v$ by Lemma 3.2.3. \square

3.11. Involutions via gluing. Consider an even lattice L , an involution $c: L \rightarrow L$, and its eigenlattices $L_\pm = \{x \in L \mid c(x) = \pm x\}$. The following straightforward proposition showing how c can be described in terms of 2-elementary subgroups of $\text{discr } L_\pm$ is essentially Proposition 1.2.1 in [N3].

3.11.1. Proposition.

- (1) *An involution $c: L \rightarrow L$ yields a presentation of L as a result of gluing $L = L_+ +_\phi L_-$ of its eigenlattices along an anti-isomorphism $\phi: K_+ \rightarrow K_-$ between 2-elementary subgroups $K_\pm \subset \text{discr } L_\pm$.*
- (2) *Conversely, if a lattice L is glued from sublattices, $L = L_+ +_\phi L_-$, along an anti-isomorphism $\phi: K_+ \rightarrow K_-$ between 2-elementary subgroups $K_\pm \subset \text{discr } L_\pm$, then there exists an involution $c: L \rightarrow L$, for which L_\pm are the (± 1) -eigenlattices. \square*

Let $r_2(L, c)$ denote the $\mathbb{Z}/2$ -rank of the group $L/(L_+ + L_-)$. Let c_2 denote the induced involution in $L_2 = L \otimes \mathbb{Z}/2$, $L_2^{c_2} = \{x \in L_2 \mid c(x) = x\}$ the invariant subgroup, and $r_2(L_2, c_2) = \text{rank}(L_2/L_2^{c_2})$.

3.11.2. Proposition. *Assume that L has odd discriminant. Then,*

- (1) $\delta_2(L_+) = 0$ if and only if (L, c) is of type I.
- (2) $r_2(L, c) = r_2(L_2, c_2) = r_2(L_\pm)$.

Proof. The preimage of $L_2^{c_2}$ under the reduction homomorphism $L \rightarrow L \otimes \mathbb{Z}/2 = L_2$ is $L_+ \oplus L_-$, which implies $r_2(L, c) = r_2(L_2, c_2)$. Each element $a \in \text{discr}_2 L_+$ is represented by an element of the form $\frac{1}{2}(x \pm cx)$, $x \in L$, which implies $r_2(L, c) = r_2(L_\pm)$. To prove (1), it remains to notice that $\mathfrak{q}(a) = (\frac{1}{2}(x + cx))^2 = \frac{1}{2}(x^2 + x \cdot cx) = \frac{1}{2}x \cdot cx \in \mathbb{Q}/\mathbb{Z}$. \square

3.12. Stability. An even lattice L is called *stable* if any other even lattice L' having the same inertia indices, $r_+(L') = r_+(L)$ and $r_-(L') = r_-(L)$, and isometric discriminants, $(\text{discr } L', \mathfrak{q}_{L'}) = (\text{discr } L, \mathfrak{q}_L)$, is isomorphic to L . Let us call an even lattice L *epistable* (respectively, *p-epistable*) if any automorphism of $\text{discr } L$ (respectively, of $\text{discr}_p L$) is induced by some automorphism of L .

The following Nikulin's criterion shows that such complications as non-stability or non-epistability may happen only if the lattice has the extremal or next to extremal value, r or $r - 1$, (cf. Proposition 3.4.1) of the ranks r_p for some prime p .

3.12.1. Theorem. (Nikulin [N1]) *Assume that a lattice L of rank $r > 1$ is even, indefinite, and the ranks r_p satisfy the following conditions:*

- (1) $r_p \leq r - 2$ for all primes $p \neq 2$;
- (2) if $r_2 = r$, then $\text{discr}_2 L$ contains \mathcal{U}_2 or \mathcal{V}_2 as a direct summand.

Then L is both stable and epistable (and in particular, p-epistable for all p). \square

Note that, as it follows from Proposition 3.6.3, the condition (2) is satisfied, if $\text{discr}_2 L$ is 2-elementary and $r_2 = r > 2$, so the condition (2) requires analysis only for $r_2 = r = 2$. The case $r = 1$, i.e. $L = \langle 2n \rangle$, excluded from the criterion is trivial.

3.13. Different involutions with the same eigenlattices. Consider a pair of even lattices T^1 and T^2 with involutions, $c_i: T^i \rightarrow T^i$, whose eigenlattices are isomorphic, $T_{\pm}^1 = T_{\pm}^2$. By Proposition 3.11.1, $T^i = T_+^i +_{\phi^i} T_-^i$, where $\phi^i: K_+^i \rightarrow K_-^i$, $i = 1, 2$, are anti-isomorphisms between $K_{\pm}^i \subset \text{discr}_2 T_{\pm}^i$. We say that involutions c_1 and c_2 are *conjugate via some isomorphism* $f: T^1 \rightarrow T^2$ if $f \circ c_1 = c_2 \circ f$. The description of isomorphisms via gluing in Lemma 3.9.4 yields easily the following.

3.13.1. Proposition. *The following conditions are equivalent:*

- (1) c_1 and c_2 are conjugate via some isomorphism $f: T^1 \rightarrow T^2$;
- (2) there exists an isomorphism $f: T^1 \rightarrow T^2$ which maps isomorphically T_{\pm}^1 onto T_{\pm}^2 ;
- (3) there exist isomorphisms $f_{\pm}: T_{\pm}^1 \rightarrow T_{\pm}^2$ such that the induced ones, $f_{\pm}^{\text{discr}_2}: \text{discr}_2 T_{\pm}^1 \rightarrow \text{discr}_2 T_{\pm}^2$, map isomorphically K_{\pm}^1 onto K_{\pm}^2 so that the following diagram commutes.

$$\begin{array}{ccc} K_+^1 & \xrightarrow{f_+^{\text{discr}_2}} & K_+^2 \\ \phi^1 \downarrow & & \phi^2 \downarrow \\ K_-^1 & \xrightarrow{f_-^{\text{discr}_2}} & K_-^2 \quad \square \end{array}$$

In what follows, the lattices T^i will have $r_2 = 1$. This additional assumption implies that $|r_2(T_+^i) - r_2(T_-^i)| = 1$, and if $r_2(T_+^i) < r_2(T_-^i)$ then K_+^i is the whole group $\text{discr}_2 T_+^i$, which is glued to a subgroup of corank 1, $K_-^i \subset \text{discr}_2 T_+^i$. The case $r_2(T_-^i) < r_2(T_+^i)$ can be treated symmetrically.

3.13.2. Proposition. *Assume that $r_2(T_-^i) = r_2(T_+^i) + 1$ and $K_+^i = \text{discr}_2 T_+^i$. Then c_i , $i = 1, 2$, on $T^i = T_+^i +_{\phi^i} T_-^i$ with the eigenlattices T_{\pm}^i are conjugate via some isomorphism $T^1 \rightarrow T^2$ if any one of the following conditions is satisfied:*

- (1) the lattice T_-^1 is 2-epistable;
- (2) the lattice T_+^1 is 2-epistable and $\text{Aut}(T_-^1)$ acts transitively on the subgroups of $\text{discr}_2 T_-^1$ anti-isomorphic to $\text{discr}_2 T_+^1$.

Proof. Note that the orthogonal complements of K_-^i in $\text{discr}_2 T_-^i$ are isomorphic, since the enhanced-group structures on $\mathbb{Z}/2$ are determined by the Brown invariant. Thus, K_-^1 is sent to K_-^2 by some isomorphism $f_-^{\text{discr}_2}: \text{discr}_2 T_-^1 \rightarrow \text{discr}_2 T_-^2$. Moreover, we can choose it so that the diagram in Proposition 3.13.1(3) commutes. In the case (1), the 2-epistability of $T_-^1 \cong T_-^2$ implies existence of an isomorphism $f_-: T_-^1 \rightarrow T_-^2$ inducing $f_-^{\text{discr}_2}$. Then, Proposition 3.13.1 implies that c_1 and c_2 are conjugate via f defined by $f_+ = \text{id}$ and f_- constructed as above. In the case (2), we can find $f_-: T_-^1 \rightarrow T_-^2$ such that the induced map in $\text{discr}_2(T_-^1)$ sends K_-^1 to K_-^2 . Then we can use the epistability of T_+^1 to construct $f_+: T_+^1 \rightarrow T_+^2$ which is compatible with f_- , that is the diagram like in Proposition 3.13.1 commutes, and we again conclude that c_1 and c_2 are conjugate. \square

4. TOPOLOGY AND ARITHMETICS OF THE COVERING K3-SURFACES

4.1. Covering K3 after desingularization. In addition to the cuspidal K3-surface Y introduced in Section 2.8 and obtained by taking the double covering of P^2 ramified along a Zariski curve A , we take also into consideration the non-singular K3 surface \tilde{Y} obtained by the minimal resolution of the six cusps of Y . Note that \tilde{Y} inherits from Y a pair of complex conjugations that differ by the deck transformation of the double covering $\tilde{Y} \rightarrow \tilde{P}^2$ of the plane blown-up at the

six cusps, $\tilde{P}^2 \rightarrow P^2$. This covering is ramified along the proper transform of the Zariski curve and fits in a commutative diagram

$$\begin{array}{ccc} \tilde{Y} & \longrightarrow & Y \\ \tilde{\pi} \downarrow & & \pi \downarrow \\ \tilde{P}^2 & \longrightarrow & P^2. \end{array}$$

Like for Y , we give preference to that complex conjugation whose real locus, $\tilde{Y}(\mathbb{R})$, is projected to \mathcal{A}_n , call it the *Möbius involution* (or *Möbius real structure*) in \tilde{Y} and denote by $\text{conj} = \text{conj}_{\tilde{Y}}$.

The K3-lattice $L = H_2(\tilde{Y})$ contains a sublattice $6\mathbb{A}_2$ spanned by the twelve exceptional divisors of the resolution and the *polarization class* h , $h^2 = 2$, which is represented by the pull-back of a line in P^2 . In what follows, we work with a natural "gluing" reconstruction of L from two complementary sublattices: the primitive closure $S \subset L$ of the sublattice spanned by $6\mathbb{A}_2$ and h , and the orthogonal complement $T = S^\perp = \{x \in L \mid xS = 0\}$. We will consider also the sublattice $S^0 = \{x \in S \mid xh = 0\} \subset S$ and its orthogonal complement $T' = (S^0)^\perp$. All the sublattices, S , T , S^0 , and T' are invariant with respect to the complex conjugation involution $c = \text{conj}_* : L \rightarrow L$, and we denote by $L_\pm = \{x \in L \mid c(x) = \pm x\}$, $S_\pm = L_\pm \cap S$, $T_\pm = L_\pm \cap T$, $S_\pm^0 = S^0 \cap L_\pm$, and $T'_\pm = T' \cap L_\pm$ the corresponding eigenlattices. Note that $T'_+ = T_+$ and $S_+^0 = S_+$, since $c(h) = -h$ and thus $h \in T'_- \cap S_-$. It follows also that T_- (respectively, S_-^0) is the orthogonal complement of h in T'_- (respectively, in S_-).

In particular, we obtain a relation to the ranks r_\pm introduced in Section 2.8.

4.1.1. Lemma.

$$\begin{aligned} r_+ &= \text{rank } T_+, \\ r_- &= \text{rank } T_- + 1, \end{aligned}$$

Proof. It follows from that $H_*(Y; \mathbb{Q}) = H_*(\tilde{Y}; \mathbb{Q}) / (6\mathbb{A}_2 \otimes \mathbb{Q}) = \mathbb{Q}h + T \otimes \mathbb{Q}$ and $h \in L_-$. \square

4.2. Deficiency in the Smith inequalities. As it follows from the Smith theory applied to the complex conjugation involution, the relations $b_*(X(\mathbb{R}); \mathbb{Z}/2) \leq b_*(X; \mathbb{Z}/2)$ and $b_*(X(\mathbb{R}); \mathbb{Z}/2) = b_*(X; \mathbb{Z}/2) \pmod{2}$ (here, as before, X and $X(\mathbb{R})$ stand for the set of complex and real points respectively) hold for any complex algebraic variety X defined over \mathbb{R} . The variety X is called *M-variety* if $b_*(X(\mathbb{R}); \mathbb{Z}/2) = b_*(X; \mathbb{Z}/2)$, and *(M-d)-variety* where $d = \frac{1}{2}(b_*(X; \mathbb{Z}/2) - b_*(X(\mathbb{R}); \mathbb{Z}/2))$ otherwise (for instance, one speaks on (M-d)-curves, (M-d)-surfaces, etc.).

First of all, let us compare $d(A) = 5 - \ell(A)$ of a real Zariski sextic A and $d(Y) = \frac{1}{2}(12 - b_*(Y(\mathbb{R}); \mathbb{Z}/2))$ of the double covering K3-surface Y .

4.2.1. Lemma. *If we choose in Y the Möbius real structure, then $d(Y) = 5 - \ell(A)$. Otherwise (for the non-Möbius real structure), $d(Y) = 6 - \ell(A)$.*

Proof. Since $Y(\mathbb{R})$ projects to \mathcal{A}_\pm as an orientation double covering with boundary glued to itself via deck transformation, it follows that $b_*(Y(\mathbb{R}); \mathbb{Z}/2) = 2b_*(\mathcal{A}_\pm; \mathbb{Z}/2)$, which is $2 + 2\ell(A)$ in the case of \mathcal{A}_n (i.e., Möbius real structure), and $2\ell(A)$ in the case of \mathcal{A}_o . \square

Since the links of cusps are $\mathbb{Z}/2$ -homology spheres, the variety Y is a $\mathbb{Z}/2$ -homology manifold. Thus, its $\mathbb{Z}/2$ -valued intersection form $\langle x, y \rangle$, $x, y \in H_2(Y; \mathbb{Z}/2)$, is well-defined and non-degenerate. One can also twist the intersection form via the involution $c: H_2(Y; \mathbb{Z}/2) \rightarrow H_2(Y; \mathbb{Z}/2)$ and define $\langle x, y \rangle_c = \langle x, c(y) \rangle$.

We let $H_2^c(Y; \mathbb{Z}/2) = \{x \in H_2(Y; \mathbb{Z}/2) \mid c(x) = x\}$ and put, similarly to the notation in Section 3.11, $r_2(H_2(Y; \mathbb{Z}/2), c) = \text{rank } H_2(Y; \mathbb{Z}/2) / H_2^c(Y; \mathbb{Z}/2)$.

4.2.2. Lemma. *If $c: H_2(Y; \mathbb{Z}/2) \rightarrow H_2(Y; \mathbb{Z}/2)$ is induced by a complex conjugation in Y such that $Y(\mathbb{R}) \neq \emptyset$, then $d(Y) = r_2(H_2(Y; \mathbb{Z}/2), c)$.*

Proof. Since $H_1(Y; \mathbb{Z}/2) = H_3(Y; \mathbb{Z}/2) = 0$ and the Smith sequence

$$\begin{aligned} \cdots \rightarrow H_{r+1}(Y/\text{conj}, Y(\mathbb{R}); \mathbb{Z}/2) &\rightarrow H_r(Y/\text{conj}, Y(\mathbb{R}); \mathbb{Z}/2) \oplus H_r(Y(\mathbb{R}); \mathbb{Z}/2) \xrightarrow{\text{tr}^r + \text{in}_r} \\ &\rightarrow H_r(Y; \mathbb{Z}/2) \xrightarrow{\text{pr}_r} H_r(Y/\text{conj}, Y(\mathbb{R}); \mathbb{Z}/2) \rightarrow \cdots \end{aligned}$$

is exact, it is sufficient to show that the image of $\text{tr}^2 + \text{in}_2$ is equal to $H_2^c(Y; \mathbb{Z}/2)$. Such an equality follows from the relation $\text{tr}^* \circ \text{pr}_* = 1 + c$ and, again, the exactness of the Smith sequence. \square

Remark. If $Y(\mathbb{R}) = \emptyset$ then $d(Y) = r_2(H_2(Y; \mathbb{Z}/2), c) - 2$. Here, one can bypass the Smith theory and argue a bit differently. Namely, since the quotient Y/conj is a $\mathbb{Z}/2$ -manifold, the image of $H_2(Y/\text{conj}; \mathbb{Z})/\text{Tors}$ by the Gysin homomorphism in $H_2(Y; \mathbb{Z})/\text{Tors}$ is a lattice of the form $L'(2)$ where L' has an odd discriminant. Therefore, this lattice is primitively embedded in $H_2(Y; \mathbb{Z})/\text{Tors}$, which implies that $r_2(H_2(Y; \mathbb{Z}), c) = \text{rank } L'$. It remains to notice that Proposition 3.11.2(2) implies $r_2(H_2(Y; \mathbb{Z}), c) = r_2(H_2(Y; \mathbb{Z}/2), c)$, and that $\text{rank } L' = \dim H_2(Y/\text{conj}; \mathbb{Q}) = \frac{1}{2} \dim H_*(Y; \mathbb{Q}) - 2 = \frac{1}{2} \dim H_*(Y; \mathbb{Z}/2) - 2$. \square

4.2.3. Lemma. *The Gysin homomorphism $\rho^!: H_2(Y; \mathbb{Z}/2) \rightarrow H_2(\tilde{Y}; \mathbb{Z}/2)$ induced by the projection $\rho: \tilde{Y} \rightarrow Y$ is a monomorphism and its image is $T' \otimes \mathbb{Z}/2 = T'/2T' \subset L/2L = L \otimes \mathbb{Z}/2 = H_2(\tilde{Y}; \mathbb{Z}/2)$.*

The isomorphism $H_2(Y; \mathbb{Z}/2) \rightarrow T'/2T'$ provided by $\rho^!$ commutes with the involutions induced by the complex conjugation in Y and \tilde{Y} and preserves the $\mathbb{Z}/2$ -valued intersection forms. It sends $H_2^c(Y; \mathbb{Z}/2)$ to $(T'_+ + T'_-) \otimes \mathbb{Z}/2$ and induces an isomorphism

$$H_2(Y; \mathbb{Z}/2)/H_2^c(Y; \mathbb{Z}/2) \rightarrow (T'/(T'_+ + T'_-)) \otimes \mathbb{Z}/2 = T'/(T'_+ + T'_-).$$

Proof. It follows from $\rho_* \circ \rho^! = \text{id}$ and absence of 2-torsion in $H_2(Y)$ and $H_2(\tilde{Y})$. \square

4.2.4. Corollary. *For any real Zariski sextic A and Möbius involution in \tilde{Y} we have $r_2(T_+) = r_2(T', c) = d(Y) = d(A)$. If $A(\mathbb{R}) \neq \emptyset$, and we choose a non-Möbius involution in \tilde{Y} , then $r_2(T_+) = r_2(T', c) = d(A) + 1$. \square*

Proof. From Proposition 3.11.2 it follows that $r_2(T'_+) = r_2(T', c) = r_2(T'_2, c)$. Since $T'_+ = T_+$ and $r_2(T'_2, c) = r_2(H_2(Y; \mathbb{Z}/2), c)$, the remaining parts of the statement follow from Lemmas 4.2.1, 4.2.2, and 4.2.3. \square

4.3. Real varieties of type I. The following is a version of the so-called Arnold lemma, which is valid for any real algebraic surface Y that is a $\mathbb{Z}/2$ -homology manifold and, in particular, in our case of the double plane $Y \rightarrow P^2$ branched along Zariski sextic.

4.3.1. Lemma. *The fundamental class $[Y(\mathbb{R})] \in H_2(Y; \mathbb{Z}/2)$ is the characteristic class of the bilinear form $\langle x, y \rangle_c$, that is, for any $x \in H_2(Y; \mathbb{Z}/2)$ we have $\langle x, x \rangle_c = \langle x, [Y(\mathbb{R})] \rangle_c$.*

Proof. We pick a $\mathbb{Z}/2$ -cycle C representing an element $x \in H_2(Y; \mathbb{Z}/2)$, which is smooth at the non-singular points of Y and generic with respect to $Y(\mathbb{R})$, and then check that any intersection point of C with $Y(\mathbb{R})$ gives an odd contribution to both $\langle x, c(x) \rangle$ and $\langle x, [Y(\mathbb{R})] \rangle$. At the smooth points of $Y(\mathbb{R})$ genericness means transversality and this contribution is 1. At the singular points, the intersection number can be replaced by the linking number (here, genericness means that the links of C , $c(C)$, and $Y(\mathbb{R})$ are disjoint). Namely, in a 3-link of each real singular point we can fill the local link, $\text{lk}(C)$, of C by a smooth 2-membrane, M_C , $\text{lk}(C) = \partial M_C$, transversal to

its conjugate, $\text{lk}(c(C)) = \partial c(M_C)$, and notice that $M_C \cap c(M_C)$ is a c -equivariant 1-manifold bounding the 0-cycle $(C \cap c(M_C)) \cup (c(C) \cap M_C)$. Finally, it remains to observe that each non-closed connected component of this 1-manifold fixed by c intersects $Y(\mathbb{R})$ at one point, each closed connected component fixed by c intersects $Y(\mathbb{R})$ at two points, while the other (non fixed) components come in pairs and are disjoint from $Y(\mathbb{R})$. This implies that the linking number of $\text{lk}(C)$ with $\text{lk}(Y(\mathbb{R}))$ has the same parity as with $\text{lk}(c(C))$. \square

4.3.2. Corollary. *The following conditions are equivalent.*

- (1) *The fundamental class $[Y(\mathbb{R})] \in H_2(Y; \mathbb{Z}/2)$ vanishes.*
- (2) *The c -twisted intersection form is even, that is $\langle x, x \rangle_c = 0$ for all $x \in H_2(Y; \mathbb{Z}/2)$.* \square

A real algebraic surface (Y, c) is said to be of type I if the conditions of Corollary 4.3.2 are satisfied, otherwise, we say that it is of type II.

4.3.3. Lemma. *The following conditions are equivalent.*

- (1) *The pair (Y, c) is of type I;*
- (2) *The pair $(T', c|_{T'})$ is of type I;*
- (3) *The discriminant form in $\text{discr}_2(T'_+) = \text{discr}_2(T_+)$ is even, or in the other words, $\delta_2(T_+) = 0$.*

Proof. Since the Gysin homomorphism $\rho^!: H_2(Y; \mathbb{Z}/2) \rightarrow H_2(\tilde{Y}; \mathbb{Z}/2)$ commutes with conj , preserves the $\mathbb{Z}/2$ -intersection form and, by Lemma 4.2.3, establishes an isomorphism between $H_2(Y; \mathbb{Z}/2)$ and $T'/2T'$, the equivalence between (1) and (2) follows from Corollary 4.3.2. The equivalence between (2) and (3) follows from Proposition 3.11.2. \square

4.3.4. Lemma. *A Zariski sextic A is of type I if and only if Y is of type I with respect to the Möbius real structure.*

Proof. Due to Corollary 4.3.2 and exactness of the Smith sequence written for the deck transformation of the double covering $Y \rightarrow P^2$, it is sufficient to check that $[\mathcal{A}_n] \in H_2(P^2, A; \mathbb{Z}/2)$ is zero if A is of type I (note that it is non zero, otherwise). But if A is of type I, one can apply Rokhlin's trick: consider instead $[\mathcal{A}_n] + [\mathbb{R}P^2] = [\mathcal{A}_o]$, lift the latter up to an integer homology cycle $R = [\mathcal{A}_o] + [A_\pm] \in H_2(P^2)$ (here, A_\pm denote the two components of $A \setminus A(\mathbb{R})$) and check that $R = \frac{1}{2}(R - \text{conj}_* R) = \frac{1}{2}[A] \in H_2(P^2)$, while $\frac{1}{2}[A]$ reduced modulo 2 is equal to $[\mathbb{R}P^2] \in H_2(P^2; \mathbb{Z}/2)$. \square

4.3.5. Proposition. *A Zariski sextic A is of type I if and only if $\delta_2(T_+(\tilde{Y})) = 0$, where \tilde{Y} is endowed with the Möbius real structure.*

Proof. It is a straightforward consequence of Lemmas 4.3.4 and 4.3.3. \square

4.4. Resolution decoration of $H_2(\tilde{Y})$. Given a K3-lattice $L = 3\mathbb{U} + 2\mathbb{E}_8$, we say that (Δ, h) is a *decoration of L* and that L is (Δ, h) -*decorated*, if $\Delta \subset L$ is a set of twelve elements called the *exceptional classes* forming a basis of $6\mathbb{A}_2$ (i.e., $\Delta = \{e'_1, e''_1, \dots, e'_6, e''_6\}$, $(e'_i)^2 = (e''_i)^2 = -2$, $e'_i e''_i = 1$, and $e'_i e'_j = e'_i e''_j = e''_i e''_j = 0$ for $1 \leq i \neq j \leq 6$) and $h \in L$ is an element orthogonal to Δ such that $h^2 = 2$.

In the case of the K3-surface \tilde{Y} obtained by resolution of singularities of the double plane $Y \rightarrow P^2$ ramified along a Zariski sextic $4p^3 + 27q^2 = 0$, such kind of decoration appears naturally in $L = H_2(\tilde{Y}) \cong H^2(\tilde{Y})$: the exceptional curves lying above the six \mathbb{A}_2 -singularities of Y provide the exceptional classes $e'_i, e''_i \in \Delta$, and $h \in L$ is the polarization class of the projection $\tilde{Y} \rightarrow Y \rightarrow P^2$ (it can be geometrically thought of as the pull-back of a generic line in P^2). We call this decoration a *resolution decoration*.

This resolution, and hence the decoration, can be enriched by a consideration of the pullback of the conic $p = 0$. Indeed, the resolution of the cusps together with the pullback of the conic can

be obtained in two steps: first, blowing up of P^2 at the six cusps, and, second, taking the double covering ramified along the proper transform of the Zariski sextic. As a result, if the conic is nonsingular, we get as its pullback the two (-2) -curves that are proper transforms of the conic and the twelve exceptional curves E'_i, E''_i . Let us denote these two (-2) -curves by Q', Q'' . Under appropriate ordering, the Dynkin-Coxeter graph of this collection of curves looks as on Figure 3a).

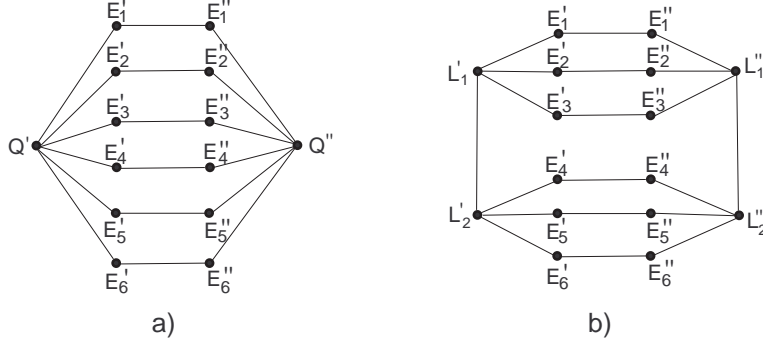

FIGURE 3.

If the conic is singular, it splits in a union of two distinct lines, each containing three of the six cusps. The pullback of each line splits into two (-2) -curves. Let us denote these two pairs by L'_1, L''_1 and L'_2, L''_2 . Under an appropriate ordering, L'_1 intersects L'_2 and L''_1 intersects L''_2 . We fix such an ordering and put $Q' = L'_1 + L'_2$, $Q'' = L''_1 + L''_2$. The Dynkin-Coxeter graph of the collection $L'_1, L'_2, L''_1, L''_2, E'_1, \dots, E'_6$ is as on Figure 3b).

4.4.1. Lemma. *For any Zariski sextic, the following relations hold in $L = H_2(\tilde{Y})$:*

$$[Q'] = h - \sum \frac{e''_i + 2e'_i}{3}, \quad [Q''] = h - \sum \frac{e'_i + 2e''_i}{3}.$$

Proof. Since the both sides in each of the identities to be proved are of square -2 , the result follows just from a straightforward verification that the both sides have the same intersection indices with $h, e'_1, e''_1, \dots, e'_6, e''_6$, which in turn follows from the incidence relations shown on the above Dynkin-Coxeter graphs. \square

4.5. The Galois S_3 -coverings. One of the consequences of Lemma 4.4.1 is that $6A_2$ is not a primitive sublattice of L . A more conceptual explanation of this non-primitiveness consists in appealing to the Galois covering $Z \rightarrow P^2$ with the Galois group S_3 (symmetric group on a set of three elements) induced by the central projection $\pi_X : X \rightarrow P^2$. This covering has the following remarkable properties:

- (1) Z is a nonsingular $K3$ -surface with a holomorphic S_3 -action;
- (2) the subgroup $C_3 \subset S_3$ formed by even permutations acts on Z symplectically (i.e., trivially on the holomorphic differential 2-forms);
- (3) the quotient Z/C_3 is canonically identified with Y ;
- (4) the C_3 -action has precisely six fixed points and they are the pullback of the six cusps of Y .

In particular, we obtain the following diagram of projections

$$\begin{array}{ccc} Z & \longrightarrow & Y \\ \downarrow & & \downarrow \pi_Y \\ X & \xrightarrow{\pi_X} & P^2. \end{array}$$

Just an existence of such a nontrivial cyclic order three covering $Z \rightarrow Y$ implies that $6\mathbb{A}_2$ is not primitive in L . Namely, we obtain the following well-known property.

4.5.1. Lemma. *The primitive closure S^0 of $6\mathbb{A}_2$ in L is an extension of index 3.*

Proof. Since the discriminant order $|\text{discr } 6\mathbb{A}_2| = 3^6$ is a power of 3, the index $[S^0 : 6\mathbb{A}_2]$ is also a power of 3 and, therefore, coincides with the order of $H^1(Y \setminus \text{Sing } Y; \mathbb{Z}/3)$. The latter group is nontrivial, since a connected C_3 -covering of $Y \setminus \text{Sing } Y$ is provided by $Z \rightarrow Y$. It is isomorphic to $\mathbb{Z}/3$, since Z is smooth at the six points z_1, \dots, z_6 that form the pull back of $\text{Sing } Y$ and by this reason $Z \setminus \{z_1, \dots, z_6\}$ does not admit any further nontrivial C_3 -covering. \square

4.5.2. Proposition. *For any resolution decoration of $L = H_2(\tilde{Y})$,*

- (1) *the order in each pair of \mathbb{A}_2 -generators $e'_i, e''_i \in \Delta$ can be chosen in such a way that the element $\sigma = (e'_1 - e''_1) + \dots + (e'_6 - e''_6)$ is divisible by 3 in L ;*
- (2) *the primitive closure S^0 is spanned by $\Delta \cup \{\frac{\sigma}{3}\}$;*
- (3) *the sublattice S spanned by $\Delta \cup \{\frac{\sigma}{3}, h\}$ in L is primitive and splits into a direct sum $\langle 2 \rangle + S^0$, where $\langle 2 \rangle$ is generated by h .*

Proof. Statements (1) and (2) are immediate consequences of Lemmas 4.4.1 and 4.5.1. Statement (3) follows from absence of 2-torsion in the discriminant of S^0 . \square

4.5.3. Corollary. (1) $\text{discr}(S^0) = \langle \frac{2}{3} \rangle + 3\langle -\frac{2}{3} \rangle$.

(2) S has the following direct sum decompositions: $S = \langle 2 \rangle + S^0 = \langle 2 \rangle + \mathbb{E}_6 + 3\mathbb{A}_2 = \mathbb{U} + \mathbb{A}_5 + 3\mathbb{A}_2$.

Proof. By Proposition 4.5.2(2) and Lemma 3.8.1, we have $\text{discr } S^0 = [\frac{\sigma}{3}]^\perp / [\frac{\sigma}{3}]$, where $[\frac{\sigma}{3}] \in \text{discr } 6\mathbb{A}_2 = 6\langle -\frac{2}{3} \rangle$ is the diagonal element. It follows now from Lemma 3.7.2 that $\text{discr } S^0 = p\langle \frac{2}{3} \rangle + q\langle -\frac{2}{3} \rangle$, $p + q = 4$, where $2(p - q) = \text{Br}(S^0) = \text{Br}(6\mathbb{A}_2) = 4 \pmod{8}$, which gives (1).

Part (2) follows from Theorem 3.12.1, since $\text{discr}(S^0) = \langle -\frac{2}{3} \rangle + 3\langle \frac{2}{3} \rangle$, $\text{discr } \mathbb{E}_6 = \langle \frac{2}{3} \rangle$, $\text{discr } \mathbb{A}_2 = \langle -\frac{2}{3} \rangle$, and $\text{discr } \mathbb{A}_5 = \langle -\frac{5}{6} \rangle = \langle \frac{1}{2} \rangle + \langle \frac{2}{3} \rangle$. \square

4.5.4. Proposition. *The Galois covering $Z \rightarrow P^2$ inherits a real structure, $c_Z : Z \rightarrow Z$, from the real structure of the cubic surface X . This real structure, c_Z , commutes with the Galois action of $C_3 \subset S_3$ on Z and descends to real structures $c_Y : Y \rightarrow Y$, $c_{\tilde{Y}} : \tilde{Y} \rightarrow \tilde{Y}$ (as Y is identified with Z/C_3) commuting with the deck transformation of $Y \rightarrow P^2$ and the resolution of singularities $\tilde{Y} \rightarrow Y$; the real parts $Y(\mathbb{R})$ and $\tilde{Y}(\mathbb{R})$ are projected to $\mathcal{A}_- \subset P^2_{\mathbb{R}}$.*

Conversely, if $Y(\mathbb{R})$ is nonempty and a real structure $c : \tilde{Y} \rightarrow \tilde{Y}$ commutes with the involution $\tilde{Y} \rightarrow \tilde{Y}$ induced by the deck transformation $Y \rightarrow Y$, then c lifts to a real structure $c_Z : Z \rightarrow Z$. Moreover:

- (1) *if $c_*(\sigma) = \sigma$, then the above c_Z commutes with the Galois action of C_3 ;*
- (2) *if $c_*(\sigma) = -\sigma$, then c_Z together with the C_3 -action form an action of a semi-direct product, $C_3 \rtimes \mathbb{Z}/2 = S_3$.*

Proof. The direct statements is a straightforward consequence of the construction of Galois coverings induced by a given projection. The assumption $Y(\mathbb{R}) \neq \emptyset$ in the converse statement is only for insuring that the lift of c is an involution. Finally, the commutator relation $c_Z \circ \theta = \theta^{o(c)} \circ c_Z$, where $o(c)$ is defined by $(c_Z)_*(\sigma) = o(c)\sigma$, follows from the Poincaré-Lefschetz duality (that transforms $\frac{1}{3}\sigma$ into a characteristic element of the Galois covering over $Y \setminus \text{Sing } Y$, cf., proof of Lemma 4.5.1) and the construction of cyclic coverings. \square

4.6. Abstract K3-lattice conical (Δ, h) -decorations. We say that a (Δ, h) -decoration of a K3-lattice L is *conical* if it satisfies the properties (1)–(2) (and thus, also (3)) of Proposition 4.5.2. According to this Proposition, each resolution decoration is conical.

The properties (1) and (2) in Proposition 4.5.2 imply that, for a given conical (Δ, h) -decoration of L , the choice of σ is unique up to sign. We call σ the Δ -*master element*. Thus, the choice of a Δ -master element determines the order (e'_i, e''_i) of generators in each of the \mathbb{A}_2 -components of Δ , but not the order of the indices $1 \leq i \leq 6$. The choice of the opposite Δ -master element alternates the order of \mathbb{A}_2 -generators.

Given a conically (Δ, h) -decorated K3-lattice L , we denote by T and T' (in accordance with Section 4.1) the orthogonal complements of sublattices S and S^0 , respectively.

4.6.1. Lemma. *The following properties hold for any K3-lattice with a conical (Δ, h) -decoration.*

- (1) T' is an extension of $T + \langle 2 \rangle$ of index 2. Namely, T' is obtained by adding to T an element $\frac{1}{2}(h + x)$ where $x \in T$ is a primitive element and $x.T \subset 2\mathbb{Z}$.
- (2) There are following isomorphisms

$$\begin{aligned} T &= \mathbb{U} + \mathbb{U}(3) + 2\mathbb{A}_2 + \mathbb{A}_1 = \langle 6 \rangle + \mathbb{U} + 3\mathbb{A}_2 = \mathbb{A}_2(-1) + 3\mathbb{A}_2 + \mathbb{A}_1, \\ T' &= 2\mathbb{U} + \mathbb{U}(3) + 2\mathbb{A}_2. \end{aligned}$$

Proof. Since $\text{discr}(S^0)$ and $\text{discr}(T')$ are isomorphic as groups, the first statement follows from the absence of 2-torsion in $\text{discr}(S^0)$. The second statement follows from Theorem 3.12.1, $\text{discr}(T') = -\text{discr}(S^0) = \langle \frac{2}{3} \rangle + 3\langle -\frac{2}{3} \rangle$, $\text{discr } \mathbb{U}(3) = \langle \frac{2}{3} \rangle + \langle -\frac{2}{3} \rangle$, $\text{discr } \mathbb{A}_2 = \langle -\frac{2}{3} \rangle$, $\text{discr}(T) = -\text{discr}(S) = \langle -\frac{1}{2} \rangle + \text{discr}(T')$, $\text{discr}\langle 6 \rangle = \langle \frac{1}{6} \rangle = \langle -\frac{1}{2} \rangle + \langle \frac{2}{3} \rangle$, and Lemma 3.7.2. \square

By an isomorphism between a pair of K3-lattices, L_1 and L_2 , decorated with (Δ_1, h_1) and (Δ_2, h_2) respectively, we mean a lattice isometry $f: L_1 \rightarrow L_2$ such that $f(\Delta_1) = \Delta_2$ and $f(h_1) = h_2$.

We denote by $\text{Aut}(L, \Delta, h)$ the group of automorphisms of a (Δ, h) -decorated K3-lattice L . We let also $\overline{\text{Aut}}(L, \Delta, h) = \{f \mid -f \in \text{Aut}(L, \Delta, h)\}$.

4.6.2. Lemma. *If a (Δ, h) -decoration of a K3-lattice L is conical, then for a Δ -master element σ and any $f \in \text{Aut}(L, \Delta, h)$ we have $f(\sigma) = \pm\sigma$.*

Proof. Straightforward consequence of the definitions (properties (1) and (2) in Proposition 4.5.2). \square

For any f from $\text{Aut}(L, \Delta, h)$ or $\overline{\text{Aut}}(L, \Delta, h)$ we define $o(f) \in \{+, -\}$ by imposing the relation $f(\sigma) = o(f)\sigma$.

4.6.3. Corollary. *Let $c: L \rightarrow L$ be induced by the Möbius involution in \tilde{Y} . Then $c \in \overline{\text{Aut}}(L, \Delta, h)$ and $o(c) = o(A)$, where A is the Zariski sextic of \tilde{Y} .*

Proof. Due to Proposition 4.5.4, if $f': L \rightarrow L$ is induced by c_Z , then $f' \in \overline{\text{Aut}}(L, \Delta, h)$ and $o(f') = +$. Thus, there remains to notice that $o(\mathcal{A}) = +$ if and only if $p: X(\mathbb{R}) \rightarrow P^2(\mathbb{R})$ is three-fold over the nonorientable half of $P^2(\mathbb{R})$, and that the deck transformation of $\tilde{Y} \rightarrow P^2$ reverses the master element σ . The latter follows from Lemma 4.4.1, since the deck transformation permutes Q', Q'' . \square

4.6.4. Proposition. *If $L_i, i = 1, 2$ are conical (Δ_i, h_i) -decorated K3-lattices, then they are isomorphic as decorated K3-lattices.*

Proof. Using an isomorphism for T in Lemma 4.6.1, we obtain a required isomorphism of K3-lattices applying Lemma 3.9.4. \square

4.7. S^0 -eigenlattices. As above, let us consider a real Zariski sextic A , the Möbius involution conj on \tilde{Y} , and the induced involution $c: L \rightarrow L$. The latter obviously preserves each of the sublattices S, T, S^0, T' invariant. Let us mark with indices \pm (e.g., S_{\pm}, T_{\pm} , etc.), the corresponding ± 1 -eigenlattices.

If in a lattice M its element $v \in M$ is not divisible by $d > 1$, but vx is divisible by d for all $x \in M$, and v^2 is divisible by d^2 , then by adding element $\frac{v}{d}$ to L we obtain its extension (still an integral lattice) of index d , which we denote by $[M]_{\frac{v}{d}}$. In this notation, $S^0 = [6\mathbb{A}_2]_{\frac{\sigma}{3}}$.

4.7.1. Proposition. *The eigenlattices S_{\pm}^0 are determined up to isomorphism by the number ν_i of imaginary pairs of cusps of A and the sign $o(A) \in \{+, -\}$, as is indicated in the Table 2.*

TABLE 2

| The case of $o = -$ | | | The case of $o = +$ | | |
|---------------------|--------------------|---|---------------------|---|------------------------------------|
| ν_i | S_+^0 | S_-^0 | ν_i | S_+^0 | S_-^0 |
| 0 | 0 | $[6\mathbb{A}_2]_{\frac{\sigma}{3}}$ | 0 | $[6\langle -6 \rangle]_{\frac{\sigma}{3}}$ | $6\mathbb{A}_1$ |
| 1 | $\mathbb{A}_2(2)$ | $[4\mathbb{A}_2 + \mathbb{A}_2(2)]_{\frac{\sigma}{3}}$ | 1 | $[4\langle -6 \rangle + \mathbb{A}_2(2)]_{\frac{\sigma}{3}}$ | $4\mathbb{A}_1 + \mathbb{A}_2(2)$ |
| 2 | $2\mathbb{A}_2(2)$ | $[2\mathbb{A}_2 + 2\mathbb{A}_2(2)]_{\frac{\sigma}{3}}$ | 2 | $[2\langle -6 \rangle + 2\mathbb{A}_2(2)]_{\frac{\sigma}{3}}$ | $2\mathbb{A}_1 + 2\mathbb{A}_2(2)$ |
| 3 | $3\mathbb{A}_2(2)$ | $[3\mathbb{A}_2(2)]_{\frac{\sigma}{3}} = \mathbb{E}_6(2)$ | 3 | $[3\mathbb{A}_2(2)]_{\frac{\sigma}{3}} = \mathbb{E}_6(2)$ | $3\mathbb{A}_2(2)$ |

Proof. As follows from Corollary 4.6.3, the master element σ defining the extension $S^0 = [6\mathbb{A}_2]_{\frac{\sigma}{3}}$ is preserved by c if $o = +$, and reversed otherwise. If $o = -$, then each real cusp gives $\mathbb{A}_2 \subset S_-^0$. If $o = +$, then at each real cusp we have $c(e'_i) = -e''_i$, so that $e'_i + e''_i \in S_-^0$ and $e'_i - e''_i \in S_+^0$. A pair of imaginary cusps gives a copy of $\mathbb{A}_2(2)$ in S_+^0 and another copy in S_-^0 . \square

4.7.2. Corollary. *For any real Zariski sextic and the associated eigenlattices S_{\pm}^0 , we have*

$$\text{discr}_3 S_+^0 = p\langle -\frac{2}{3} \rangle + q\langle \frac{2}{3} \rangle, \quad \text{discr}_3 S_-^0 = (1-p)\langle -\frac{2}{3} \rangle + (3-q)\langle \frac{2}{3} \rangle$$

where $p = 1, 0 \leq q \leq 3$ if $o(c) = +$ and $p = 0, 0 \leq q \leq 3$ if $o(c) = -$.

Under such a presentation, the number ν_i of imaginary pairs of cusps is q if $p = 1$, and $3 - q$ if $p = 0$. \square

A pair of lattices isomorphic to one of the eight pairs (S_+^0, S_-^0) in Table 2 will be called an S -pair. Each component, S_{\pm}^0 , of such a pair will be called an S -half.

4.8. Geometric involutions. We say that a lattice *hyperbolic* if its positive inertia index equals 1 and the negative inertia index is ≥ 0 (with the usual abuse of terminology if the latter is 0). We say that an involution $c: L \rightarrow L$ in a conical (Δ, h) -decorated K3-lattice L is *geometric* if the following conditions are satisfied:

- (1) $c \in \overline{\text{Aut}}(L, \Delta, h)$;
- (2) the eigenlattices $T_{\pm}(c)$ are hyperbolic.

4.8.1. Lemma. *For any geometric involution $c: L \rightarrow L$ of a conical (Δ, h) -decorated K3-lattice L , the pair of eigenlattices $T_{\pm} = T_{\pm}(c)$ has the following properties:*

- (1) $r(T_+) + r(T_-) = 9$;
- (2) T_{\pm} have no other discriminant factors than 2 and 3, and the latter ones are both elementary;
- (3) $|r_2(T_+) - r_2(T_-)| = 1$,
- (4) the eigenlattice whose rank r_2 is greater has $\delta_2 = 1$;
- (5) $\text{discr}_3 T_+ + \text{discr}_3 T_- = \langle \frac{2}{3} \rangle + 3\langle -\frac{2}{3} \rangle$.

Proof. Statement (1) follows from $r(S) + r(T_+) + r(T_-) = r(L)$. Statement (2) follows from Lemma 3.11.1 applied to $h \in T'$ and Proposition 3.11.1. If $T'_- = \mathbb{Z}h + T_-$ then $\text{discr}_2(T_+) = -\langle \frac{1}{2} \rangle + \text{discr}_2(T_-)$ and $r_2(T_+) = r_2(T_-) + 1$, otherwise, T'_- is obtained by a nontrivial gluing $\mathbb{Z}h +_\phi T_-$ and then $r_2(T_+) = r_2(T_-) - 1$, so that in both cases we get (3) and (4). Statement (5) follows from $\text{discr}(S^0) = \langle -\frac{2}{3} \rangle + 3\langle \frac{2}{3} \rangle$ (see Corollary 4.5.3) and Proposition 3.11.1. \square

Let us call a geometric involution *ascending* if $r_2(T_+) < r_2(T_-)$ and *descending* otherwise. Similarly, a complex conjugation on \tilde{Y} is called *ascending involution* or *ascending real structure* if the induced by it geometric involution is ascending; otherwise, we call it *descending involution* or *descending real structure*.

4.8.2. Lemma. *Assume that A is a Zariski sextic, and c is the involution in $L = H_2(\tilde{Y})$ induced by one of the two lifting of the complex conjugation from P^2 to \tilde{Y} . Then:*

- (1) c is geometric;
- (2) if c is induced by the Möbius real structure and $A(\mathbb{R}) \neq \emptyset$, then c is ascending;
- (3) if c is induced by the non-Möbius real structure and $A(\mathbb{R}) \neq \emptyset$, then c is descending.

Proof. The involution c is geometric, since each lift of the complex conjugation from P^2 to \tilde{Y} sends the exceptional divisors and the polarization to the exceptional divisors and the polarization, reversing their orientation, and as any anti-holomorphic involution, permutes the Hodge summands, $H^{2,0}$ and $H^{0,2}$. Since $r_2(T_+) = r_2(T'_+) = r_2(T', c)$, Corollary 4.2.4 implies (2) and (3). \square

Let $C(L, \Delta, h)$ denote the set of geometric involutions, and let $C^<(L, \Delta, h)$, $C^>(L, \Delta, h)$ denote the set of the ascending and descending ones respectively. The group $\text{Aut}(L, \Delta, h)$ acts on $C(L, \Delta, h)$ preserving the subsets $C^<(L, \Delta, h)$ and $C^>(L, \Delta, h)$ invariant. Let $C[L, \Delta, h]$, $C^<[L, \Delta, h]$, and $C^>[L, \Delta, h]$ denote the orbit spaces (i.e., the set of conjugacy classes) of geometric involutions, ascending ones, and descending ones respectively. We say that two geometric involutions have the same *homological type*, if they represent the same element in $C[L, \Delta, h]$.

4.9. T-pairs and T-halves. We say that a pair of even hyperbolic lattices (T_1, T_2) form a *T-pair* if they satisfy the five properties stated in Lemma 4.8.1 for (T_+, T_-) . A T-pair will be called *ascending (descending)* if $r_2(T_1) < r_2(T_2)$ (respectively $r_2(T_1) > r_2(T_2)$).

4.9.1. Lemma. *For any ascending T-pair (T_1, T_2) or descending T-pair (T_2, T_1)*

$$\begin{aligned} r_2(T_1) &\leq \min(r(T_1), 8 - r(T_1)), \\ r_2(T_2) &\leq \min(r(T_2), 10 - r(T_2)). \end{aligned}$$

In particular, $r_2(T_1) \leq 4$, and $r_2(T_2) \leq 5$, where $r_2(T_2) = 5$ implies that $r(T_1) = r_2(T_1) = 4$ and $r(T_2) = 5$. \square

Proof. It follows from properties (1) and (3) combined with the bounds $r_2(T_i) \leq r(T_i)$, see Proposition 3.4.1. \square

A lattice is called a *T-half* if it is a component, T_1 or T_2 , of some T-pair. The following is a straightforward consequence of Lemma 4.8.1.

4.9.2. Proposition. *If M is a T-half, then:*

- (1) M is hyperbolic of rank $1 \leq r \leq 8$;
- (2) M has no discriminant p -factors different from $p = 2, 3$, and the latter ones (if exist) are elementary;
- (3) M has either $r_2 \leq 4$, or $r_2 = r = 5$, and in the latter case, it can be only the second component of an ascending T-pair;
- (4) $\text{discr}_3 M = p\langle \frac{2}{3} \rangle + q\langle -\frac{2}{3} \rangle$, where $0 \leq p \leq 1$ and $0 \leq q \leq 3$. \square

4.9.3. Proposition. *For any $c \in C(L, \Delta, h)$, the S^0 -eigenlattices (S_+^0, S_-^0) , the T -eigenlattices (T_+, T_-) , and T'_- must satisfy the following relations.*

- (1) *The pair (S_+^0, S_-^0) is an S -pair.*
- (2) *T_\pm are T -halves and either (T_+, T_-) or (T_+, T'_-) is an ascending T -pair.*
- (3) *$\text{discr}_3 T_\pm$ is anti-isomorphic to $\text{discr}_3 S_\pm^0$, and in particular $r_3(T_\pm) = r_3(S_\pm^0)$.*
- (4) *$\text{discr}_2 T_+$ is anti-isomorphic to $\text{discr}_2 T'_-$, and in particular $|r_2(T_+) - r_2(T'_-)| = 1$.*

Proof. Any automorphism of S^0 sends σ to $\pm\sigma$, thus, $6\mathbb{A}_2 \subset S^0$ is preserved invariant. An automorphism of $6\mathbb{A}_2$ must permute its \mathbb{A}_2 -components, and then, the arguments similar to that of Proposition 4.7.1 can be applied to obtain (1). (2) follows immediately from definitions. Since $\text{discr}(L_\pm)$ for the \pm -eigenlattices L_\pm are elementary 2-groups as it follows from Proposition 3.11.1, gluing of L_\pm from T_\pm , and S_\pm involves an anti-isomorphism of their discr_3 -components according to Proposition 3.9.3, which implies (3). Since $\text{discr} T$ is an elementary 3-group, the discr_2 -components of T_+ and T'_- are anti-isomorphic, again by Proposition 3.9.3, which implies (4). \square

Property (3) in Proposition 4.9.3 shows that the pair (p, q) describing $\text{discr}_3(T_+)$ (or equivalently, $\text{discr}_3(T_-)$) determines and is determined by the pair $r_3(T_+) = p + q$ and $o(c)$. Namely, it shows that Corollary 4.7.2 can be restated as follows.

4.9.4. Corollary. *The ranks $0 \leq p \leq 1$ and $0 \leq q \leq 3$ in the decompositions $\text{discr}_3 T_+ = p\langle\frac{2}{3}\rangle + q\langle-\frac{2}{3}\rangle$, $\text{discr}_3 T_- = (1-p)\langle\frac{2}{3}\rangle + (3-q)\langle-\frac{2}{3}\rangle$ determine $o(c)$ and the number ν_i as follows:*

- (1) *if $p = 1$, then $o(c) = +$ and $\nu_i = q$;*
- (2) *if $p = 0$, then $o(c) = -$ and $\nu_i = 3 - q$. \square*

4.9.5. Lemma. *For any T -pair (T_1, T_2) , $\text{Br}_2(T_1) + \text{Br}_2(T_2) = -1$.*

Proof. Applying Corollary 3.7.4 to T_i , $i = 1, 2$, we get $\text{Br}_2(T_i) + \text{Br}_3(T_i) = (2 - r(T_i))$, where $\text{Br}_3(T_i) = 2(p_i - q_i)$ if $\text{discr}_3 T_i = p_i\langle\frac{2}{3}\rangle + q_i\langle-\frac{2}{3}\rangle$. Using $r(T_1) + r(T_2) = 9$ and $\text{discr}_3 T_1 + \text{discr}_3 T_2 = \langle\frac{2}{3}\rangle + 3\langle-\frac{2}{3}\rangle$ we conclude that $\text{Br}_2(T_1) + \text{Br}_2(T_2) = (4 - 9) - 2(1 - 3) = -1$. \square

4.9.6. Lemma. *Assume that (T_1, T_2) is an ascending T -pair. Then $K_1 = \text{discr}_2 T_1$ is anti-isomorphic to a subgroup $K_2 \subset \text{discr}_2 T_2$ if and only if K_2 is the orthogonal complement v^\perp of an element $v \in \text{discr}_2 T_2$ satisfying the following conditions:*

- (1) $\mathfrak{q}_{T_2}(v) = -\frac{1}{2} \in \mathbb{Q}/2\mathbb{Z}$;
- (2) v is a Wu element if and only if $\delta_2(T_1) = 0$.

Proof. If K_2 is anti-isomorphic to K_1 , then K_2 is a non-degenerate subgroup of $\text{discr}_2 T_2$ of corank $r_2(T_2) - r_2(T_1) = 1$ and, therefore, $K_2 = v^\perp$ for some $v \in \text{discr}_2 T_2$. Furthermore, $\text{Br}_2(T_1) = \text{Br}(K_1) = -\text{Br}(K_2)$, and additivity of Br implies $\text{Br}_2(T_2) = \text{Br}(K_2) + \text{Br}\langle v \rangle$. and $\text{Br}\langle v \rangle = 2\mathfrak{q}_{T_2}(v) \pmod{4}$ by Lemma 3.6.4(3). Thus, $\text{Br}_2(T_1) + \text{Br}_2(T_2) = 2\mathfrak{q}_{T_2}(v) \pmod{4}$, which equals $-1 \pmod{4}$ by Lemma 4.9.5 and thus gives condition (1). Lemma 3.6.4(2) implies condition (2).

Conversely, if $v \in \text{discr}_2 T_2$ satisfies condition (2), then $\delta_2(K_2) = \delta_2(K_1)$. If v satisfies condition (1), then $\text{Br}\langle v \rangle = -1$ (see Lemma 3.6.4(4)), and thus $\text{Br}(K_2) = \text{Br}_2(T_2) + 1$. Applying Lemma 4.9.5 we get $\text{Br}(K_1) = \text{Br}_2(T_1) = -1 - \text{Br}_2(T_2) = -\text{Br}(K_2)$ and by means of Theorem 3.6.3 conclude that K_1 is anti-isomorphic to K_2 . \square

4.10. Admissible T -halves and pairs of Möbius involutions. Given a Zariski sextic A , let c_1 denote the Möbius involution in $L = H_2(\tilde{Y})$, and c_2 be the non-Möbius one.

4.10.1. Proposition. $T_{\pm}(c_2) = T_{\mp}(c_1)$ for any Zariski sextic A . Moreover, in the case $A(\mathbb{R}) = \emptyset$,

- (1) $T_+(c_1) = T_-(c_2)$ have $r = r_2 = 5$ and $\delta_2 = 1$;
- (2) $T_-(c_1) = T_+(c_2)$ have $r = r_2 = 4$ and $\delta_2 = 0$.

Proof. Note that $c_2 \circ c_1 = c_1 \circ c_2$ is induced by the deck transformation of the covering $\tilde{Y} \rightarrow \tilde{P}^2$, and the action of the deck transformation in $H_2(\tilde{Y})$ is equal to the product of pairwise commuting maps $-\rho_h$ and $\rho_{e'_i + e''_i}$, $i = 1, \dots, 6$, where ρ_v stands for the reflection $x \mapsto x - 2\frac{xv}{v^2}v$. Therefore, $T_{\pm}(c_2) = T_{\mp}(c_1)$.

In the case of $A(\mathbb{R}) = \emptyset$, Lemma 2.8.1 gives values $r_+ = r_- = d(A) = 5$ for the involution c_1 , and applying Lemma 4.1.1 we obtain the values of $r(T_{\pm}(c_1)) = r(T_{\pm}(c_2))$ indicated in (1)–(2).

Corollary 4.2.4 implies that $r_2(T_+(c_1)) = 5$. The parity $\delta_2 = 0$ for $T_+(c_2)$, and thus for $T_-(c_1)$, follows from Corollary 4.3.2. The imparity $\delta_2 = 1$ for $T_+(c_1)$, and thus for $T_-(c_2)$, follows from Proposition 4.3.5, since $A(\mathbb{R}) = \emptyset$ implies that A has type II. Finally, the values of $r_2(T_{\pm}(c_1))$, and thus of $r_2(T_{\pm}(c_2))$, indicated in (1)–(2) follow from Lemmas 4.2.1 and Corollary 4.2.4. \square

5. ARITHMETICS OF GEOMETRIC INVOLUTIONS

5.1. Automorphisms of 3-elementary inner product groups of small rank. Here, we analyze the automorphisms of $\text{discr}(S^0) \cong \langle -\frac{2}{3} \rangle + 3\langle \frac{2}{3} \rangle \cong \langle \frac{2}{3} \rangle + 3\langle -\frac{2}{3} \rangle$ (see Corollary 4.5.3) and of its non-degenerate subgroups.

Note that each permutation of coordinates followed by an alternation of signs of some components, $(x_1, \dots, x_n) \mapsto (\pm x_{\sigma(1)}, \dots, \pm x_{\sigma(n)})$, provides an automorphism of $n\langle \frac{2}{3} \rangle$, as well as of $n\langle -\frac{2}{3} \rangle$. These "coordinatewise" automorphisms form a group that we denote by $\text{Aut}_{\text{comp}}(n\langle \pm \frac{2}{3} \rangle)$. It is isomorphic to the group of symmetries of an n -cube and fits canonically in an exact sequence $1 \rightarrow (\mathbb{Z}/2)^n \rightarrow \text{Aut}_{\text{comp}}(n\langle \pm \frac{2}{3} \rangle) \rightarrow S_n \rightarrow 1$.

5.1.1. Lemma. *If $1 \leq n \leq 3$, then $\text{Aut}(n\langle \pm \frac{2}{3} \rangle) = \text{Aut}_{\text{comp}}(n\langle \pm \frac{2}{3} \rangle)$.*

Proof. Note that for $q = n\langle \pm \frac{2}{3} \rangle$ the expression $q(x_1, \dots, x_n) = \pm \frac{2}{3}(x_1^2 + \dots + x_n^2) \pmod{2\mathbb{Z}}$ depends only on the number of non-zero coordinates modulo 3. Thus, for $n \leq 3$ the elements of the direct summands in $n\langle \pm \frac{2}{3} \rangle$ are distinguished from all the other elements if $n \leq 3$. Hence, any automorphism in $\text{Aut}(n\langle \pm \frac{2}{3} \rangle)$ with $n \leq 3$ is coordinatewise. \square

Now, consider an enhanced group $(G, q) = 6\langle -\frac{2}{3} \rangle$ and denote by $\delta = \sum_{i=1}^6 a_i$ the *diagonal element*, that is the sum of the generators a_i of all the $\langle -\frac{2}{3} \rangle$ -components of G . Note that δ is *isotropic*, that is $\delta^2 = 0$, and thus $\delta \in G^\delta = \{x \in G \mid x\delta = 0\}$.

We put $b_{j_1 \dots j_q}^{i_1 \dots i_p} = (a_{i_1} + \dots + a_{i_p}) - (a_{j_1} + \dots + a_{j_q}) \in G$, and in the case $\delta b_{j_1 \dots j_q}^{i_1 \dots i_p} = -\frac{2}{3}(p - q) = 0$, we denote by $[b_{j_1 \dots j_q}^{i_1 \dots i_p}]$ the coset in $G^\delta / (\delta)$. Since δ is isotropic, the quotient group $G^\delta / (\delta)$ inherits from G the inner product and quadratic form.

5.1.2. Lemma. *The non-trivial elements of the group $G^\delta / (\delta) = \langle -\frac{2}{3} \rangle + 3\langle \frac{2}{3} \rangle$ break up into 3 sets:*

- (1) 30 elements $[b_j^i]$, $1 \leq i, j \leq 6$, $i \neq j$, of square $\frac{2}{3}$;
- (2) 30 elements $[b_{kl}^{ij}]$ of square $-\frac{2}{3}$, where $1 \leq i, j, k, l \leq 5$ are distinct;
- (3) 20 isotropic (i.e., of square 0) elements $[b^{ijk}]$, $1 \leq i < j < k \leq 6$.

Proof. Straightforward. \square

5.1.3. Lemma. *The elements $b_{34}^{12}, b_2^1, b_4^3, b_6^5$ split the enhanced group $G^\delta/(\delta)$ in an orthogonal direct sum $\langle -\frac{2}{3} \rangle + 3\langle \frac{2}{3} \rangle$.*

Proof. Straightforward. \square

5.2. Reduction homomorphism. Keeping the notation of the previous Subsection, we consider the automorphism group $\text{Aut } G$ and study its subgroups:

$$\begin{aligned}\text{Aut}(G, \delta) &= \{f \in \text{Aut}(G) \mid f(\delta) = \pm\delta\}, \\ \text{Aut}_{\text{comp}}(G, \delta) &= \{f \in \text{Aut}_{\text{comp}}(G) \mid f(\delta) = \pm\delta\}, \\ \text{Aut}_{\text{comp}}^+(G, \delta) &= \{f \in \text{Aut}_{\text{comp}}(G, \delta) \mid f(\delta) = \delta\}.\end{aligned}$$

The induced homomorphism $\text{Aut}(G, \delta) \rightarrow \text{Aut}(G^\delta/(\delta)) = \text{Aut}(\langle -\frac{2}{3} \rangle + 3\langle \frac{2}{3} \rangle)$ will be called the *reduction homomorphism*.

5.2.1. Proposition.

- (1) $\text{Aut}_{\text{comp}}^+(G, \delta) = S_6$ and $\text{Aut}_{\text{comp}}(G, \delta) = S_6 \times \mathbb{Z}/2$.
- (2) *The reduction homomorphism restricted to $\text{Aut}_{\text{comp}}(G, \delta)$ is an isomorphism $S_6 \times \mathbb{Z}/2 = \text{Aut}_{\text{comp}}(G, \delta) \rightarrow \text{Aut}(G^\delta/(\delta)) = \text{Aut}(\langle -\frac{2}{3} \rangle + 3\langle \frac{2}{3} \rangle)$.*

5.2.2. Lemma. *$\text{Aut}_{\text{comp}}(G, \delta)$ acts effectively and transitively on the set of $\frac{2}{3}$ -elements $[b_j^i] \in G^\delta/(\delta)$.*

Proof. It follows from the description of $\frac{2}{3}$ -elements in Lemma 5.1.2. \square

Proof of Proposition 5.2.1. The claim (1) is straightforward, since δ is preserved by a coordinatewise automorphism if and only if it is defined by a simple permutation (without any sign reversion).

Lemma 5.2.2 implies that the reduction homomorphism is injective on $\text{Aut}_{\text{comp}}(G, \delta)$. To show that it is isomorphic, it is sufficient to check that the order of the group $\text{Aut}(\langle -\frac{2}{3} \rangle + 3\langle \frac{2}{3} \rangle)$ coincides with that of $\text{Aut}_{\text{comp}}(G, \delta)$.

The order of $\text{Aut}_{\text{comp}}(G, \delta)$ is equal to $|S_6 \times \mathbb{Z}/2| = 2 \cdot 6!$. On the other hand, by Lemma 5.2.2 the group $\text{Aut}(\langle -\frac{2}{3} \rangle + 3\langle \frac{2}{3} \rangle)$ acts transitively on the 30 elements $[b_j^i]$. The stabilizer of an element $[b_j^i]$ is isomorphic to $\text{Aut}(3\langle -\frac{2}{3} \rangle)$, since the orthogonal complement of $[b_j^i]$ in $G^\delta/(\delta) = \langle \frac{2}{3} \rangle + 3\langle -\frac{2}{3} \rangle$ is isomorphic to $3\langle -\frac{2}{3} \rangle$ (see Lemma 3.7.2). This implies that the order of $\text{Aut}(\langle -\frac{2}{3} \rangle + 3\langle \frac{2}{3} \rangle)$ is $30|\text{Aut}(3\langle \frac{2}{3} \rangle)|$, where by Lemma 5.1.1 $|\text{Aut}(3\langle \frac{2}{3} \rangle)| = 8|S_3| = 48$. \square

Remark. In fact, it is not difficult to prove that $\text{Aut}(G, \delta) = \text{Aut}_{\text{comp}}(G, \delta)$, and, therefore, Proposition 5.2.1(2) means that the reduction homomorphism is an isomorphism. \square

Now, assume that $c_G \in S_6 \times \mathbb{Z}/2 = \text{Aut}_{\text{comp}}(G, \delta)$ is an involution acting on G . It induces an involution c_G^δ in $\langle -\frac{2}{3} \rangle + 3\langle \frac{2}{3} \rangle = G^\delta/(\delta)$. Let $\text{Aut}_{\text{comp}}(G, \delta, c_G) = \{f \in \text{Aut}_{\text{comp}}(G, \delta) \mid f \circ c_G = c_G \circ f\}$ and $\text{Aut}(\langle -\frac{2}{3} \rangle + 3\langle \frac{2}{3} \rangle, c_G^\delta) = \{f \in \text{Aut}(\langle -\frac{2}{3} \rangle + 3\langle \frac{2}{3} \rangle) \mid f \circ c_G^\delta = c_G^\delta \circ f\}$. As an immediate corollary, we obtain the following equivariant version of Proposition 5.2.1(2).

5.2.3. Corollary. *The isomorphism in Proposition 5.2.1(2) restricts to an isomorphism*

$$\text{Aut}_{\text{comp}}(G, \delta, c_G) \rightarrow \text{Aut}(\langle -\frac{2}{3} \rangle + 3\langle \frac{2}{3} \rangle, c_G^\delta). \quad \square$$

5.3. Equivariant epistability of S^0 . The proof of the following Lemma is straightforward.

5.3.1. Lemma. *There is a canonical isomorphism $\text{discr}(S^0) = G^\delta/(\delta)$.* \square

Given a subset $D \subset L$ in a lattice L , we let $\text{Aut}(L, D) = \{f \in \text{Aut } L \mid f(D) = D\}$. We say that L is *D-relatively epistable* if the induced homomorphism $\text{Aut}(L, D) \rightarrow \text{Aut}(\text{discr } L)$ is surjective.

5.3.2. Proposition. *The induced projection $\text{Aut}(S^0, \Delta) \rightarrow \text{Aut}(\text{discr } S^0)$ is an isomorphism. In particular, S^0 is Δ -relatively epistable.*

Proof. Each automorphism $f \in \text{Aut}(S^0, \Delta)$ preserves the sublattice $6\mathbb{A}_2 \subset S^0$, permutes its \mathbb{A}_2 -components, and preserves or reverses the Δ -master element $\sigma \in 6\mathbb{A}_2$ that is responsible for the extension of $6\mathbb{A}_2$ to S^0 . Thus, the induced automorphism in $G = \text{discr}(6\mathbb{A}_2)$ preserves or reverses δ . This yields a homomorphism $\text{Aut}(S^0, \Delta) \rightarrow \text{Aut}_{\text{comp}}(G, \delta) = S_6 \times \mathbb{Z}/2$, which is an isomorphism. Now, it is left to apply Lemma 5.3.1 and Proposition 5.2.1(2). \square

Let $\overline{\text{Aut}}(S^0, \Delta) = \{f \in \text{Aut}(S^0) \mid -f \in \text{Aut}(S^0, \Delta)\}$.

5.3.3. Corollary. *The projection $\overline{\text{Aut}}(S^0, \Delta) \rightarrow \text{Aut}(\text{discr } S^0)$ is bijective. Thus, any involution in $\text{discr } S^0$ can be lifted to an involution of S^0 which sends Δ to $-\Delta$.*

Proof. Given $\phi \in \text{Aut}(\text{discr } S^0)$, let $f \in \text{Aut}(S^0, \Delta)$ be a lifting of $-\psi$ existing by Proposition 5.3.2. Then $-f \in \overline{\text{Aut}}(S^0, \Delta)$ is a lifting of ϕ that we need. \square

Now, consider an involution $c \in C(L, \Delta, h)$ and the induced involutions, c_G on G and c_G^δ on $\text{discr } S^0 = G^\delta/(\delta)$. Let $\text{Aut}(S^0, \Delta, c) = \{f \in \text{Aut}(S^0, \Delta) \mid fc = cf\}$, and $\text{Aut}(\text{discr } S^0, c_G^\delta) = \{\phi \in \text{Aut}(\text{discr } S^0) \mid \phi c_G^\delta = c_G^\delta \phi\}$.

5.3.4. Corollary. *A restriction of the isomorphism of Proposition 5.3.2 yields an isomorphism $\text{Aut}(S^0, \Delta, c) \cong \text{Aut}(\text{discr } S^0, c_G^\delta)$.*

Proof. By definition, $-c$ belongs to $\text{Aut}(S^0, \Delta)$ and $\text{Aut}(S^0, \Delta, c)$ coincides with the centralizer of $-c$, whereas $\text{Aut}(\text{discr } S^0, c_G^\delta)$ is the centralizer of its image $-c_G^\delta$ under the isomorphism $\text{Aut}(S^0, \Delta) \rightarrow \text{Aut}(\text{discr } S^0)$. \square

The property of S^0 indicated in Corollary 5.3.4 will be referred to as its *c-equivariant Δ -relative epistability of S^0* . In a bit more general setting, the definition looks as follows. Given a lattice L with a subset $D \subset L$ and an involution $c: L \rightarrow L$ inducing an involution c^{discr} in $\text{discr } L$, we say that L is *c-equivariant D-relative epistable* if the induced homomorphism from $\text{Aut}(L, D, c) = \{f \in \text{Aut}(L, D) \mid f \circ c = c \circ f\}$ to $\text{Aut}(\text{discr } L, c^{\text{discr}}) = \{\phi \in \text{Aut}(\text{discr } L) \mid \phi \circ c^{\text{discr}} = c^{\text{discr}} \circ \phi\}$ is surjective.

5.4. Gluing of involutions. The following statements on extending automorphisms from lattices to the result of their gluing are straightforward.

5.4.1. Lemma. *Assume that $L = L_1 +_\phi L_2$ and $L' = L_1 +_{\phi'} L_2$, where ϕ and ϕ' are anti-isomorphisms $K_1 \rightarrow K_2$ between the same subgroups $K_i \subset \text{discr } L_i$, $i = 1, 2$. Then, a pair of automorphisms $f_i: L_i \rightarrow L_i$, $i = 1, 2$ can be extended to an isomorphism $f: L \rightarrow L'$ if and only if the following set of conditions is satisfied:*

- (1) *The automorphisms $(f_i)_*$ induced by f_i on $\text{discr } L_i$ preserve subgroups K_i invariant.*
- (2) *$(f_2)_*|_{K_2} \circ \phi = \phi' \circ (f_1)_*|_{K_1}$. \square*

5.4.2. Corollary. *Automorphisms $f: L \rightarrow L$ of $L = L_1 +_\phi L_2$, $\phi: K_1 \rightarrow K_2$, such that $f(L_i) = L_i$, $i = 1, 2$, are in one-to-one correspondence with the pairs (f_1, f_2) of automorphisms of L_1 and L_2 whose induced homomorphisms $(f_1)_*: \text{discr } L_1 \rightarrow \text{discr } L_1$, $(f_2)_*: \text{discr } L_2 \rightarrow \text{discr } L_2$ preserve invariant K_1, K_2 , respectively, and commute with ϕ being restricted to K_1, K_2 . \square*

Next, we give a criterion for existence of an extension of an automorphism $f_1: L_1 \rightarrow L_1$ from L_1 to $L = L_1 +_\phi L_2$.

5.4.3. Proposition. *Let $L = L_1 +_\phi L_2$, $\phi: K_1 \rightarrow K_2$, be a gluing such that $K_2 \subset \text{discr } L_2$ is a direct summand, and lattice L_2 is epistable. Assume that $f_1: L_1 \rightarrow L_1$ is an automorphism of L_1 and $(f_1)_*(K_1) = K_1$.*

- (1) *Then f_1 can be extended to an automorphism $f: L \rightarrow L$.*

- (2) Furthermore, if $L' = L_1 +_{\phi'} L_2$, $\phi': K_1 \rightarrow K_2$, then f_1 can be extended to an isomorphism $f: L \rightarrow L'$.

Proof. Here (1) is a special case of (2), so we shall just prove the latter. Let us define $\psi_2|_{K_2} = \phi' \circ (f_1)_*|_{K_1} \circ \phi^{-1}$ and extend it to an automorphism $\psi_2: \text{discr } L_2 \rightarrow \text{discr } L_2$ using the assumption that K_2 splits off as a direct summand. Due to epistability of L_2 , we can find an automorphism $f_2: L_2 \rightarrow L_2$ such that $\psi_2 = (f_2)_*$. Now, the assumptions of Lemma 5.4.1 are satisfied and we obtain $f: L \rightarrow L'$ by gluing f_1 and f_2 . \square

Let L_i be equipped with involutions c_i and c_i^{discr} denote the induced involutions on $\text{discr } L_i$. An anti-isomorphism $\phi: K_1 \rightarrow K_2$ between c_i -invariant subgroups $K_i \subset \text{discr } L_i$ is said to be *equivariant* if it commutes with $c_i^{\text{discr}}|_{K_i}$. The following lemma is an immediate consequence of the definitions (cf. Lemma 3.9.4 and Corollary 5.4.2).

5.4.4. Lemma. *There is an involution $c: L \rightarrow L$, $L = L_1 +_{\phi} L_2$, $c|_{L_i} = c_i$, $i = 1, 2$, if and only if the anti-isomorphism ϕ is equivariant. In this case, such an involution c is unique. \square*

5.4.5. Proposition. *Assume that $L = L_1 +_{\phi} L_2$, $\phi: K_1 \rightarrow K_2$, where K_2 splits off as a direct summand, $\text{discr } L_2 = K_2 + G_2$. Fix an involution $c: L \rightarrow L$ with $c_i = c|_{L_i}$, and assume that L_2 is c_2 -equivariant D -relative epistable for some $D \subset L_2$. Let $f_1: L_1 \rightarrow L_1$ be a c_1 -equivariant automorphism inducing $(f_1)_*: \text{discr } L_1 \rightarrow \text{discr } L_1$ such that $(f_1)_*(K_1) = K_1$. Then:*

- (1) f_1 can be extended to a c -equivariant automorphism $f \in \text{Aut}(L, \Delta)$.
- (2) For any given automorphism $\phi_2^G: G_2 \rightarrow G_2$, the automorphism f in (1) can be chosen so that its restriction, $f_2: L_2 \rightarrow L_2$ induces ϕ_2^G on G_2 .
- (3) Given another equivariant anti-isomorphism $\phi': K_1 \rightarrow K_2$, with the induced from c_1 and c_2 involution c' on $L' = L_1 +_{\phi'} L_2$, there exists an extension of f_1 to an isomorphism $f: L \rightarrow L'$, which commutes with c and c' , whose restriction, $f_2: L_2 \rightarrow L_2$ induces on G_2 automorphism ϕ_2^G , and for which $f(D) = D$.

Proof. In the first part, we consider an automorphism $(f_2)_*$ on $\text{discr } L_2$ which is $\phi \circ (f_1)_* \circ \phi^{-1}$ on K_2 and ϕ_2^G on G_2 . Equivariant D -relative epistability of L_2 implies that $(f_2)_*$ can be lifted to an automorphism $f_2: L_2 \rightarrow L_2$ such that $f_2(D) = D$. The anti-isomorphism ϕ is equivariant, so, by Lemma 5.4.4 the required f exists.

The second part is similar, except that we need to start with an involution $\phi' \circ (f_1)_* \circ \phi^{-1}$ on K_2 . \square

5.5. Realizability of T-pairs by geometric involutions. In this subsection we prove existence of a geometric involution $c \in C(L, \Delta, h)$ on a (Δ, h) -decorated K3-lattice L whose pair of eigenlattices $(T_+(c), T_-(c))$ is isomorphic to a given T-pair (T_1, T_2) . Throughout the subsection this pair is supposed to be ascending, although the case of descending T-pairs is analogous. First, we show that T_1 and T_2 after an appropriate gluing give a lattice isomorphic to $T \subset L$.

5.5.1. Proposition. *For any ascending T-pair (T_1, T_2) , there exists a subgroup $K_2 \subset \text{discr}_2 T_2$ anti-isomorphic to $\text{discr}_2 T_1$. Any such subgroup is the orthogonal complement $K_2 = v^\perp$ of some $v \in \text{discr}_2(T_2)$, such that $\mathfrak{q}_{T_2}(v) = -\frac{1}{2}$.*

5.5.2. Lemma. *Assume that (T_1, T_2) is an ascending T-pair such that $\delta_2(T_1) = 0$, and $v \in \text{discr}_2 T_2$ is the characteristic element. Then $\mathfrak{q}_{T_2}(v) = -\frac{1}{2}$.*

Proof. Lemma 4.9.5 gives $\text{Br}_2(T_1) + \text{Br}_2(T_2) = -1$, and by additivity $\text{Br}_2(T_2) = \text{Br}\langle v \rangle + \text{Br}(v^\perp)$, where $\langle v \rangle \subset \text{discr}_2 T_2$ is spanned by v , while v^\perp is its orthogonal complement. Since the quadratic forms in $\text{discr}_2 T_1$ and v^\perp are even, their Brown invariants are divisible by 4, and thus $\text{Br}\langle v \rangle = -1 \pmod{4}$. This implies that $\mathfrak{q}_{T_2}(v) = -\frac{1}{2}$. \square

5.5.3. Lemma. *Assume that (G, q) is an elementary enhanced 2-group, which is not isomorphic to $n\langle \frac{1}{2} \rangle$ for $n \leq 3$, and has $\delta_2(G) = 1$ (i.e., q is odd). Then there exists an element $v \in G$, such that $q(v) = -\frac{1}{2}$. If in addition $G \neq \langle -\frac{1}{2} \rangle$, then such v can be chosen non-characteristic.*

Proof. Existence of v such that $q(v) = -\frac{1}{2}$ follows from decomposability $\text{discr}_2 L = p\langle \frac{1}{2} \rangle + q\langle -\frac{1}{2} \rangle$ (see Theorem 3.6.3) and isomorphism $4\langle \frac{1}{2} \rangle \cong 4\langle -\frac{1}{2} \rangle$. If $p+q > 1$, then a generator of a summand $\langle -\frac{1}{2} \rangle$ in such a decomposition is non-characteristic. \square

Proof of Proposition 5.5.1. By Lemma 4.9.6, it is sufficient to prove existence of $v \in \text{discr}_2(T_2)$ satisfying two conditions: first, $q_{T_2}(v) = -\frac{1}{2}$, and second, v is characteristic if $\delta_2(T_1) = 0$, and non-characteristic otherwise. Lemma 5.5.2 proves it in the case $\delta_2(T_1) = 0$. If $\delta_2(T_1) = 1$, then we can use Lemma 5.5.3 after showing that $\text{discr}_2 T_2$ cannot be isomorphic to $n\langle \frac{1}{2} \rangle$, $1 \leq n \leq 3$, or to $\langle -\frac{1}{2} \rangle$, if $\delta_2(T_1) = 1$.

Indeed, if we suppose that $\text{discr}_2 T_2 = n\langle \frac{1}{2} \rangle$, then we have $r_2(T_2) = \text{Br}_2(T_2) = n \pmod 8$, and thus, $r_2(T_1) = n - 1$ and due to Lemma 4.9.5, $\text{Br}_2(T_1) = -n - 1 \pmod 8$. On the other hand, if $\delta_2(T_1) = 1$, then $\text{discr}_2 T_1$ is isomorphic to $p\langle \frac{1}{2} \rangle + q\langle -\frac{1}{2} \rangle$, $p, q \geq 0$, and $p + q = n - 1$, $\text{Br}_2(T_1) = p - q = -n - 1 \pmod 8$, which is impossible for $1 \leq n \leq 3$. If we suppose that $\text{discr}_2 T_2 = \langle -\frac{1}{2} \rangle$, then we have $r_2(T_1) = r_2(T_2) - 1 = 0$, which contradicts to the assumption that $\delta_2(T_1) = 1$. \square

5.5.4. Proposition. *Any ascending T -pair (T_1, T_2) is isomorphic to the pair of eigenlattices $(T_+(c_T), T_-(c_T))$ of some involution c_T in the lattice T .*

Proof. By Proposition 5.5.1 an anti-isomorphism $K_1 = \text{discr}_2 T_1 \xrightarrow{\phi} K_2 \subset \text{discr}_2 T_2$ does exist, which gives due to Proposition 3.11.1, an involution, c , in $T_1 +_\phi T_2$ with the eigenlattices T_1, T_2 . So, it is left to verify that $T_1 +_\phi T_2$ is isomorphic to $T = \mathbb{U} + \mathbb{U}(3) + 2\mathbb{A}_2 + \mathbb{A}_1 \subset L$ (see Lemma 4.6.1). This follows from Nikulin's stability criterion 3.12.1 applied to $T_1 +_\phi T_2$ and T , because both lattices have the same inertia indices and isomorphic discriminants. For the latter, note that $\text{discr}_3(T_1 +_\phi T_2) = \text{discr}_3 T_1 + \text{discr}_3 T_2 = \langle \frac{2}{3} \rangle + 3\langle -\frac{2}{3} \rangle = \text{discr } T$, and that $\text{discr}_2(T_1 +_\phi T_2) = \langle -\frac{1}{2} \rangle = \text{discr}_2 T$. \square

5.5.5. Proposition. *Any involution $c_T: T \rightarrow T$ can be extended to a geometric involution $c \in C(L, \Delta, h)$.*

Proof. First, let us extend a given involution $c_T: T \rightarrow T$ to the lattice $T' = T +_{\phi_h} \langle 2 \rangle$ glued along the anti-isomorphism ϕ_h between $\text{discr}_2 T = \langle -\frac{1}{2} \rangle$ and $\langle \frac{1}{2} \rangle = \text{discr} \langle 2 \rangle$, so that the generator $h \in \langle 2 \rangle$ is sent to $-h$ (see Lemma 5.4.4). Next, we extend the involution $c_{T'}: T' \rightarrow T'$ that we obtain to L as follows.

Let $\phi: \text{discr } S^0 \rightarrow \text{discr } T'$ be the anti-isomorphism defined by the sublattices $S^0, T' \subset L$, $L = S^0 +_\phi T'$. Consider the pull-back $c_S^{\text{discr}}: \text{discr } S^0 \rightarrow \text{discr } S^0$ of the involution induced by $c_{T'}$ in $\text{discr } T'$ via ϕ . According to Corollary 5.3.3, involution c_S^{discr} can be lifted to a involution $c_S \in \overline{\text{Aut}}(S^0, \Delta)$. Then, $c_{T'}$ and c_S are compatible and thus yield an involution, c , in L (see Lemma 5.4.4) which is geometric. \square

Finally, we obtain the following theorem as a direct corollary of Propositions 5.5.4 and 5.5.5.

5.5.6. Theorem. *Any ascending T -pair (T_1, T_2) is geometric. \square*

Remark. As was mentioned in the beginning of previous Subsection, the case of descending T -pairs is analogous, so such pairs are also geometric. \square

6. DEFORMATION CLASSES VIA PERIODS

Through all this section we fix a $K3$ -lattice L and its conical (Δ, \mathbf{h}) -decoration. Note that any other conical (Δ, h) -decoration can be identified with the fixed decoration via an isomorphism, which exists due to Proposition 4.6.4.

6.1. The complex period map. Recall that, according to Proposition 4.5.2, the resolution decoration of the K3-surface \tilde{Y} associated with a Zariski sextic is conical. Turning this property into a definition we extend it to any six-cuspidal K3-surface Z which can be equipped with a lattice isomorphism $\phi : H^2(\tilde{Z}) \rightarrow \mathbb{L}$ such that the exceptional divisors of the six cusps are mapped to Δ and the preimage of h belongs to the closure of the cone generated by ample divisors (note that not any six-cuspidal K3-surface has these properties, cf., [Z1] and [D1]). By an (\mathbb{L}, Δ, h) -premarked K3-surface we mean any six-cuspidal K3-surface Z equipped with a lattice isomorphism having the above properties, the latter is called an (\mathbb{L}, Δ, h) -premarking. Thus, for K3-surfaces \tilde{Y} associated with Zariski sextics, an (\mathbb{L}, Δ, h) -premarking of \tilde{Y} is nothing but a lattice isomorphism $f : H_2(\tilde{Y}) \rightarrow \mathbb{L}$ identifying the resolution decoration with the reference conical decoration of \mathbb{L} .

Assume that $\phi : H^2(\tilde{Z}) \cong H_2(\tilde{Z}) \rightarrow \mathbb{L}$ is an (\mathbb{L}, Δ, h) -premarking of a six-cuspidal K3-surface \tilde{Z} . Then the holomorphic 2-forms in \tilde{Z} form a line $\phi(H^{2,0}(\tilde{Z})) \subset \mathbb{L}_{\mathbb{C}} = \mathbb{L} \otimes \mathbb{C}$ called the *period line* of \tilde{Z} . This line is orthogonal to the sublattice $S(\Delta) \subset \mathbb{L}$ (that is the primitive closure of the sublattice generated by Δ and h) and thus lies in $T_{\mathbb{C}} = T \otimes \mathbb{C}$. Taking the projectivization $P(T_{\mathbb{C}}) \subset P(\mathbb{L}_{\mathbb{C}})$ of $T_{\mathbb{C}} \subset \mathbb{L}_{\mathbb{C}}$ we obtain a point $\Omega = \Omega(\tilde{Z}) \in P(T_{\mathbb{C}})$ called the *period point* (or simply the *period*) of \tilde{Z} .

More generally, one can define an (\mathbb{L}, Δ, h) -premarking of a holomorphic, or continuous, family of six-cuspidal K3-surfaces (for example, associated with a holomorphic family of Zariski sextics) as a locally trivial family of premarkings, and given such a family of premarkings one obtains a well defined holomorphic, or continuous, family of period points in $P(T_{\mathbb{C}})$.

Since, due to Hodge-Riemann bilinear relations, the line $H^{2,0}(\tilde{Z})$ is isotropic and has positive paring with the complex-conjugate line $H^{0,2}(\tilde{Z}) = \overline{H^{2,0}(\tilde{Z})}$, the period point Ω belongs to the quadric $Q = \{w^2 = 0\} \subset P(T_{\mathbb{C}})$ and, more precisely, to its open subset $\hat{\mathcal{D}} = \{w \in Q \mid w\bar{w} > 0\}$. This subset has two connected components, which are exchanged by the complex conjugation (this reflects also switching from the given complex structure on \tilde{Z} to the complex-conjugate one and multiplying the marking by -1). Writing $w \in \Omega \subset T_{\mathbb{C}}$ as $w = u + iv$, $u, v \in T_{\mathbb{R}} = T \otimes \mathbb{R}$, we can reformulate the conditions $w^2 = 0, w\bar{w} > 0$ as $u^2 = v^2 > 0, uv = 0$, which implies that the real plane $\langle u, v \rangle \subset T_{\mathbb{R}}$ spanned by u and v is positive definite and bears a natural orientation $u \wedge v$ given by $u = \operatorname{Re} w, v = \operatorname{Im} w$. Note that the orientation determined similarly by the conjugate complex line $\bar{\Omega} \subset T_{\mathbb{C}}$ is the opposite one.

The orthogonal projection of a positive definite real plane in $T_{\mathbb{R}}$ onto another one is non-degenerate. Thus, to select one of the two connected components of $\hat{\mathcal{D}}$ we fix an orientation of positive definite real planes in $T_{\mathbb{R}}$ so that the orthogonal projection preserves it. We call it the *prescribed orientation* and define an (\mathbb{L}, Δ, h) -marking as an (\mathbb{L}, Δ, h) -premarking for which the orientation $u \wedge v$ of $\phi(H^{2,0}(\tilde{Z}))$ defined by the pairs $u = \operatorname{Re} w, v = \operatorname{Im} w$ for $w \in \phi(H^{2,0}(\tilde{Z}))$ is the prescribed one. We denote this component by \mathcal{D} and call it the *period domain*. By the *period mapping* we understand the mapping from the set of (\mathbb{L}, Δ, h) -marked K3-surfaces to \mathcal{D} respecting the above conventions.

By $\operatorname{Aut}^+(\mathbb{L}, \Delta, h)$ we denote the group of those automorphisms of the triple (\mathbb{L}, Δ, h) that preserve the prescribed orientation (and thus preserve \mathcal{D}). The complementary coset $\operatorname{Aut}^-(\mathbb{L}, \Delta, h) = \operatorname{Aut}(\mathbb{L}, \Delta, h) \setminus \operatorname{Aut}^+(\mathbb{L}, \Delta, h)$ consists of automorphisms exchanging the connected components of $\hat{\mathcal{D}}$.

Let us call an (\mathbb{L}, Δ, h) -marked K3-surface Z *regular*, if there is no $v \in \mathbb{L} \setminus S(\Delta)$ such that $v^2 = -2$ and $vh = v\Omega(\tilde{Z}) = 0$. The following statement is well known and follows, for example, from [SD].

6.1.1. Proposition. *If Z is a regular (\mathbb{L}, Δ, h) -marked K3-surface, then the linear system defined by h induces a degree 2 map $Z \rightarrow P^2$ and this map is a double covering of P^2 branched*

over a Zariski sextic. Moreover, this correspondence establishes an isomorphism between the space of regular (\mathbb{L}, Δ, h) -marked K3-surfaces Z and the space of (\mathbb{L}, Δ, h) -marked K3-surfaces \tilde{Y} associated with Zariski sextics. \square

Remark. By Riemann-Roch inequality, the homology classes $h - \sum \frac{e_i'' + 2e_i'}{3}$ and $h - \sum \frac{e_i' + 2e_i''}{3}$ (cf., 4.4.1) are realized in Z by effective divisors, and the conic through the cusps making the ramification sextic to be a Zariski sextic is nothing but the image of each of these divisors. \square

Part (1) of the following theorem is a standard consequence of surjectivity of the period mapping (see [Ku2]) and Proposition 6.1.1; part (2) follows from the strong Torelli theorem (see [BR]) (a systematic study of plane sextics with arbitrary homological conditions on collections of simple singularities via such an approach is undertaken in [D2]).

6.1.2. Theorem. *Assume that $\Omega \subset \mathbb{L}_{\mathbb{C}}$ is a line orthogonal to h and Δ . Then:*

- (1) *A point $\Omega \in \mathcal{D}$ is the period of a surface \tilde{Y} associated with some Zariski sextic $A \subset P^2$ and some (\mathbb{L}, Δ, h) -marking $\phi: H^2(\tilde{Y}) \rightarrow \mathbb{L}$ if and only if there is no $v \in \mathbb{L} \setminus S(\Delta)$ such that $v^2 = -2$ and $vh = v\Omega = 0$.*
- (2) *If we are given another Zariski sextic A' with an (\mathbb{L}, Δ, h) -marking $\phi': H^2(\tilde{Y}') \rightarrow \mathbb{L}$ having the same period Ω , then A with A' are projectively equivalent, and in particular, the projections of Y and Y' to P^2 are projectively equivalent. \square*

By this theorem, the image of the period mapping is the complement in \mathcal{D} of a certain arrangement \mathcal{H} of hyperplane sections. As we check below, this arrangement splits naturally in three sub-arrangements corresponding to three different kinds of codimension one degenerations: appearance of a node, gluing of two A_2 -singularities to an A_5 -singularity, and degeneration to a double ruled surface. In arithmetical terms, such a splitting of the arrangement \mathcal{H} is given by distinguishing three sets of (-2) -roots: $V_2^n = \{v \in T \mid v^2 = -2, v \neq h \pmod{2\mathbb{L}}\}$, $V_2^h = \{v \in T \mid v^2 = -2, v = h \pmod{2\mathbb{L}}\}$, and $V_2^g = \{v \in \mathbb{L} \mid v^2 = -2, vh = 0, vS^0 \neq 0, v \neq h \pmod{2\mathbb{L}}\}$. We denote by H_v the hyperplane section of \mathcal{D} defined by $xv = 0$ and, finally, define \mathcal{H} to be the union of three arrangements, $\mathcal{H} = \mathcal{H}^n \cup \mathcal{H}^h \cup \mathcal{H}^g$, where $\mathcal{H}^n = \bigcup_{v \in V_2^n} H_v$, $\mathcal{H}^h = \bigcup_{v \in V_2^h} H_v$, and $\mathcal{H}^g = \bigcup_{v \in V_2^g} H_v$.

Remark. Note that the hyperplane $xv = 0$ does not intersect \hat{D} if $v \in \mathbb{L}, v^2 = -2, vh = 0, vS^0 \neq 0$, and $v = h \pmod{2\mathbb{L}}$. Indeed, in such a case the orthogonal complement to the plane generated by v and $e \in S^0$ with $e^2 = -2, ev \geq 2$ has the positive inertia index < 3 , while if the orthogonal complement contains a point $\omega \in \hat{D}$ then it contains a positive definite 3-plane generated by $h, \operatorname{Re}\omega, \operatorname{Im}\omega$. By this reason we do not need to consider the set $\{v \in \mathbb{L} \mid v^2 = -2, vh = 0, vS^0 \neq 0, v = h \pmod{2\mathbb{L}}\}$, and even could replace V_2^g by $\{v \in \mathbb{L} \mid v^2 = -2, vh = 0, vS^0 \neq 0\}$. \square

In this notation, Theorem 6.1.2 can be rephrased as follows: *the set of periods of the K3-surfaces of Zariski sextics is the complement $\mathcal{D} \setminus \mathcal{H}$* . Furthermore, together with the strong Torelli theorem it implies the following statement, which is also well known.

6.1.3. Theorem. *The space $\mathcal{D} \setminus \mathcal{H}$ is a fine moduli space of regular (\mathbb{L}, Δ, h) -marked K3-surfaces. Its quotient by $\operatorname{Aut}^+(\mathbb{L}, \Delta, h)$ is naturally identified with the space of projective classes of Zariski sextics. \square*

Codimension 1 degenerations of regular (\mathbb{L}, Δ, h) -marked K3-surfaces are represented by non-singular points of \mathcal{H} . Speaking more formally, such a degeneration is represented by a holomorphic disc, $f: D^2 \rightarrow \mathcal{D}$, intersecting \mathcal{H} transversally at a single point, say, $f(0) \in \mathcal{H}$. This gives rise to a holomorphic family $\tilde{Y}_t, t \in D^2$, of K3-surfaces presented as double planes $\tilde{Y}_t \rightarrow P^2$ ramified along Zariski sextics A_t , experiencing a certain degeneration at $t = 0$.

6.1.4. Proposition. *Consider a codimension 1 degeneration of regular (\mathbb{L}, Δ, h) -marked K3-surfaces \tilde{Y}_t , $t \in D^2$, with the periods $f(t) \in \mathcal{D}$ degenerating to $f(0) \in H_v$, for some (-2) -root v . Then the type of the degeneration of \tilde{Y}_t and the corresponding Zariski sextics, A_t , depend on v as follows.*

- (1) *If $v \in V_2^n$, then \tilde{Y}_t as well as A_t experiences a nodal degeneration. And any nodal degeneration of A_t and \tilde{Y}_t can be represented via such a family.*
- (2) *If $v \in V_2^g$, then a pair of cusps of A_t as well as a pair of cusps of \tilde{Y}_t , experiences a degeneration to \mathbb{A}_5 -singularity. And any codimension one degeneration involving $6\mathbb{A}_2$ is a degeneration of two \mathbb{A}_2 -singularities into \mathbb{A}_5 , which can be represented via such a family.*
- (3) *If $v \in V_2^h$, then A_t degenerates into a triple conic and \tilde{Y}_t degenerates into an elliptic K3. Moreover, this elliptic K3 is a double of the ruled surface $\Sigma_4 = P_{P^1}(\mathcal{O}_{P^1}(4) \oplus \mathcal{O}_{P^1})$ branched along a union of the (-4) -section and a 6-cuspidal trigonal curve in Σ_4 where all the six cusps are coplanar, that is belong to a section of Σ_4 disjoint from the (-4) -section. And any degeneration of regular (\mathbb{L}, Δ, h) -marked K3-surfaces to such a double Σ_4 and of Zariski sextics to a triple conic can be represented via such a family.*

Proof. According to Saint-Donat's results on the projective models of K3-surfaces, see [SD], those surfaces that carry a numerically effective divisor of degree 2 generating the linear system without fixed components are the double covers of the plane branched in sextics with simple singularities, and those that carry a numerically effective divisor of degree 2 generating the linear system with a fixed component are the double covers of Σ_4 branched along a curve with simple singularities, where the curve is linear equivalent to $2c_1(\Sigma_4)$ and splits in a union of the (-4) -section E_0 and a trigonal curve $3E_0 + 12F$ disjoint from E_0 (here, F stands for the fiber of Σ_4 ; note that $c_1(\Sigma_4) = 2E_0 + 6F$). The coplanar condition in statement (3) reflects (and is equivalent to) the existence of a 6-cuspidal divisor sublattice and a master element in its extension; indeed, the proof of the sufficiency of coplanarity is literally the same as the proof of Lemma 4.4.1, while the necessity follows then from transitivity of $\text{Aut}^+(\mathbb{L}, \Delta, h)$ action on the set of V_2^h -hyperplanes. Thus, there remain to examine codimension one degenerations of Zariski sextic to a sextic with simple singularities, which is done in Lemma 6.1.5 below. \square

6.1.5. Lemma. *The only codimension one degenerations of Zariski sextics to a sextic with simple singularities are nodal degenerations and \mathbb{A}_5 -degenerations of a pair of cusps, $2\mathbb{A}_2 \subset \mathbb{A}_5$.*

Proof. Under such a degeneration $6\mathbb{A}_2$ should be primitively embedded into a sum of simple $\mathbb{A} - \mathbb{D} - \mathbb{E}$ lattices of total rank 13 (13 - 12 is the codimension). So, one of the summands, S_{2k+1} (where S is \mathbb{A}, \mathbb{D} , or \mathbb{E}), should contain $k\mathbb{A}_2$ as a primitive summand, and the other $(6 - k)$ copies of \mathbb{A}_2 should be embedded into themselves (the only possibility to be embedded primitively in codimension 0). The orthogonal complement of $k\mathbb{A}_2$ in S_{2k+1} is $\langle n \rangle$, therefore, the discriminants $k\langle -\frac{2}{3} \rangle$ and $\langle \frac{1}{n} \rangle$ are to be glued together to give $\text{discr } S_{2k+1}$. The discriminant of the latter is $\langle -\frac{2k+1}{2k+2} \rangle$ if $S_{2k+1} = \mathbb{A}_{2k+1}$, $\langle -\frac{2k+1}{4} \rangle$ if $S_{2k+1} = \mathbb{D}_{2k+1}$, and $\langle \frac{1}{2} \rangle$ in the case of \mathbb{E}_7 .

If $k\mathbb{A}_2 + \langle n \rangle$ is embedded primitively in S_{2k+1} , then $3^k n / m^2 = |\text{discr } S_{2k+1}|$, where m is the order of discriminant subgroups in $k\langle -\frac{2}{3} \rangle$ and $\langle \frac{1}{n} \rangle$ that are glued to each other. Since the 3-primary component of $\langle \frac{1}{n} \rangle$ is cyclic, the only possibilities for m are $m = 1$ and $m = 3$. This implies that $|\text{discr } S_{2k+1}|$ is either $3^k n$ or $3^{k-1} \frac{n}{3}$ with $\frac{n}{3} \in \mathbb{Z}$ in the latter case.

Let us try to embed $3\mathbb{A}_2$ in \mathbb{E}_7 . Since $|\text{discr } \mathbb{E}_7| = 2$ cannot be equal to $3^k n = 27n$ or $3^{k-1} \frac{n}{3} = 3n$, we conclude that such an embedding is impossible.

Next, let us try to embed $k\mathbb{A}_2$ in \mathbb{D}_{2k+1} . Since $|\text{discr } \mathbb{D}_{2k+1}| = 4$ does not contain 3-factors, the only possibilities are $k = 0, 1$, which is impossible for \mathbb{D}_{2k+1} because $2k + 1$ should be ≥ 4 .

If $k\mathbb{A}_2$ is embedded into \mathbb{A}_{2k+1} , then $|\text{discr } \mathbb{A}_{2k+1}| = 2k + 2$ is either $3^k n$ or $3^{k-1} \frac{n}{3}$. But $3^k n > 3k \geq 2k + 2$ for $k > 1$, so, the only option left, except $k = 1$, is $3^{k-2} n = 2k + 2$. For

$k = 1$ and 2 the latter identity gives $\frac{n}{3} = 4$ and $n = 6$ respectively, while for $k \geq 3$, it implies that $2k + 2$ is divisibly by 9 , which is impossible since $k \leq 6$.

Finally, the only remaining possibilities are $\mathbb{A}_2 \subset \mathbb{A}_3$ with \mathbb{A}_2 being orthogonal to a (-12) -vector $e_1 + 2e_2 + 3e_3$, and $2\mathbb{A}_2 \subset \mathbb{A}_5$ with $2\mathbb{A}_2$ being orthogonal to a (-6) -vector $e_1 + 2e_2 + 3e_3 + 2e_4 + e_5$. But since the embedding of $6\mathbb{A}_2$ in \mathbb{L} is not primitive and its extension contains the vector $\frac{\sigma}{3}$, the first possibility contradicts to $(e_1 - e_2)e_3 = \pm\sigma e_3 \in 3\mathbb{Z}$. \square

As we have just seen at the end of the proof of Lemma 6.1.5, if $v \in V_2^g$ then a natural (-6) -vector appears. It is nothing but the orthogonal projection of $3v$ on T . We denote the set of all these (-6) -vectors by V_6 .

6.1.6. Proposition. *The set V_6 coincides with $\{u \in T \mid u^2 = -6, uT \subset 3\mathbb{Z}\}$.*

Proof. Necessity follows immediately from the definition of V_6 . So, let us assume that $u \in T, u^2 = -6$, and $uT \subset 3\mathbb{Z}$. Then, $[\frac{u}{3}]$ is an element of square $-\frac{2}{3}$ in the 3-primary discriminant component $\text{discr}_3(T)$. Thus, $[\frac{u}{3}]$ is glued to an element of square $\frac{2}{3}$ in $\text{discr}_3(S_0)$. By Lemma 5.1.2, there exist 30 such elements $[b_j^i] = [\frac{e_i + 2e_i''}{3} + \frac{2e_j' + e_j''}{3}]$, $1 \leq i, j \leq 6, i \neq j, [b_j^i] = -[b_i^j]$. Gluing of u with, say, $[b_j^i]$ produces a (-2) -root $e = \frac{1}{3}(u - (e_i' + 2e_i'' + 2e_j' + e_j'')) \in L$ that generates $A_5 \subset L$ together with e_i', e_i'', e_j', e_j'' ; namely, e represents the ‘‘middle’’ root of A_5 , or equivalently, $u = e_i' + 2e_i'' + 3e + 2e_j' + e_j''$. Note, that $eS^0 \neq 0 \pmod{2\mathbb{Z}}$ and therefore e belongs to V_2^g . \square

To each $v \in V_2^n \cup V_2^h$ we associate the (-2) -reflection $\rho_v^T: T \rightarrow T, x \mapsto x + \langle x, v \rangle v$, and to each $u \in V_6$ the (-6) -reflection $\rho_u^T: T \rightarrow T, x \mapsto x + \frac{1}{3}\langle x, u \rangle u$. The first one is evidently the restriction to T of the (-2) -reflection $\rho_v: \mathbb{L} \rightarrow \mathbb{L}$, while the second one is the restriction to T of the reflection $\rho_u^{\mathbb{L}}: \mathbb{L} \rightarrow \mathbb{L}$ in the 3-dimensional mirror generated by the triple $e, e_i' + e_i'', e_j' + e_j''$ like in the proof of Proposition 6.1.6. Note also that for each $u \in V_6$, the hyperplane section H_u of \mathcal{D} defined by $xu = 0$ coincides with H_e we used in our definition of \mathcal{H}^g .

6.2. The real period map. Let us fix a geometric involution $c \in C(\mathbb{L}, \Delta, h)$ (see Section 4.8), extend c to a complex linear involution on $\mathbb{L} \otimes \mathbb{C}$ and denote also by c the induced involutions on $T_{\mathbb{C}}, P = P(T_{\mathbb{C}})$, and $\widehat{\mathcal{D}}$. An (\mathbb{L}, Δ, h) -marking ϕ of a real K3-surface (Z, conj) is called *c-real* if $c \circ \phi = \phi \circ \text{conj}$. If a real K3-surface (Z, conj) can be equipped with a *c-real* (\mathbb{L}, Δ, h) -marking, we say that this surface is of *homological type c*. A real Zariski sextic is said to be of homological type c , if the K3-surface \widetilde{Y} associated to it is equipped with a real structure conj lifted from the real structure of P^2 and $(\widetilde{Y}, \text{conj})$ is equipped with a *c-real* (\mathbb{L}, Δ, h) -marking.

The following Lemma shows that this definition of homological type concords with the one given in Section 4.8.

6.2.1. Lemma. *If (Z, conj) is of homological type c , and c' represents the same element in $C[\mathbb{L}, \Delta, h]$ as c , then (Z, conj) is of homological type c' as well.*

Proof. If $c = f'c'f^{-1}$ with $f \in \text{Aut}^-(\mathbb{L}, \Delta, h)$, then $c = gc'g^{-1}$ where $g = cf \in \text{Aut}^+(\mathbb{L}, \Delta, h)$. \square

The involution c permutes the two components, \mathcal{D} and $\overline{\mathcal{D}}$, of $\widehat{\mathcal{D}}$, and thus $\bar{c}(\mathcal{D}) = \mathcal{D}$, where $\bar{c}: T_{\mathbb{C}} \rightarrow T_{\mathbb{C}}$ is the composition of c with the complex conjugation in $T_{\mathbb{C}}$. Let $\widehat{\mathcal{D}}_{\mathbb{R}}^c$ and $\mathcal{D}_{\mathbb{R}}^c$ denote the fixed point sets of \bar{c} restricted to $\widehat{\mathcal{D}}$ and \mathcal{D} . The latter fixed point set consists of the lines generated by $w = u_+ + iu_-$ such that $u_{\pm} \in T_{\pm} \otimes \mathbb{R}, u_+^2 = u_-^2 > 0$, and the orientation $u_+ \wedge u_-$ is the prescribed one. Since c is geometric, both $\mathcal{D}_{\mathbb{R}}^c$ and its (trivial) double covering $\widehat{\mathcal{D}}_{\mathbb{R}}^c$ are nonempty.

As it follows from definitions, the period of a *c-real* (\mathbb{L}, Δ, h) -marked K3-surface belongs to $\mathcal{D}_{\mathbb{R}}^c = \{x \in \mathcal{D} \mid c(x) = \bar{x}\}$. Therefore, we call $\mathcal{D}_{\mathbb{R}}^c$ the *real period domain*. It splits in a direct product,

$$\mathcal{D}_{\mathbb{R}}^c = \mathcal{D}(T_+) \times \mathcal{D}(T_-),$$

where $\mathcal{D}(T_+) = \mathcal{D} \cap P(T_+ \otimes \mathbb{R})$ and $\mathcal{D}(T_-) = \mathcal{D} \cap P(T_- \otimes \mathbb{R})$ are the real hyperbolic (Lobachesvki) spaces associated with the (hyperbolic) lattices T_\pm . In other words, one can fix a half of the cone $u_+^2 > 0$ in $T_+ \otimes \mathbb{R}$ and a half of the cone $u_-^2 > 0$ in $T_- \otimes \mathbb{R}$ in a way that the prescribed halves respect the prescribed orientation (that is to make the orientation $u_+ \wedge u_-$ to be the prescribed orientation for any u_+, u_- from the fixed half-cones) and then $\mathcal{D}(T_\pm)$ become the spaces of the vector half-lines in the chosen two half-cones.

6.2.2. Theorem. *The periods of c -real regular (\mathbb{L}, Δ, h) -marked K3-surfaces form in $\mathcal{D}_{\mathbb{R}}^c$ the complement of $\mathcal{D}_{\mathbb{R}}^c \cap \mathcal{H}$. The space $\mathcal{D}_{\mathbb{R}}^c \setminus \mathcal{H}$ is a fine moduli space of c -real regular (\mathbb{L}, Δ, h) -marked K3-surfaces.*

Proof. This is a straightforward consequence of Theorems 6.1.2 and 6.1.3. \square

Let us put $V_2^n(T_\pm) = V_2^n \cap T_\pm, V_2^h(T_\pm) = V_2^h \cap T_\pm, V_6(T_\pm) = V_6 \cap T_\pm$ and define $\mathcal{H}^n(T_\pm) = \bigcup_{v \in V_2^n(T_\pm)} H_v \cap \mathcal{D}(T_\pm), \mathcal{H}^h(T_\pm) = \bigcup_{v \in V_2^h(T_\pm)} H_v \cap \mathcal{D}(T_\pm), \mathcal{H}^g(T_\pm) = \bigcup_{u \in V_6(T_\pm)} H_u \cap \mathcal{D}(T_\pm)$. We denote by Ch_\pm the set of connected components of the complement $\mathcal{D}(T_\pm) \setminus \mathcal{H}_\pm$ of the hyperplane arrangement $\mathcal{H}_\pm = \mathcal{H}^n(T_\pm) \cup \mathcal{H}^h(T_\pm) \cup \mathcal{H}^g(T_\pm)$. Every of these (infinite in number) components is obviously a convex polyhedron.

6.2.3. Lemma. *Every connected component of $\mathcal{D}_{\mathbb{R}}^c \setminus \mathcal{H}$ is obtained from a product $P_+ \times P_-$ of two polyhedra $P_\pm \in \text{Ch}_\pm$ by removing a codimension two subset. In particular, the inclusion map identifies the set of connected components of $\mathcal{D}_{\mathbb{R}}^c \setminus \mathcal{H}$ with $\text{Ch}_+ \times \text{Ch}_-$.*

Proof. The difference is due to (-2) - and (-6) -vectors $v \in V_2^n \cup V_2^h \cup V_6, v \notin T_\pm$, that have nonzero components $v_\pm \in T_\pm \otimes \mathbb{R}$ and hence $H_v \cap \mathcal{D}_{\mathbb{R}}^c = v_+^\perp \times v_-^\perp$ (orthogonal complement v_\pm^\perp is in $\mathcal{D}(T_\pm)$) is of codimension 2. \square

By $\text{Aut}^+(\mathbb{L}, \Delta, h, c)$ we denote the subgroup of $\text{Aut}^+(\mathbb{L}, \Delta, h)$ consisting of those elements of the latter that commute with c . Typical examples of such elements are ρ_v with $v \in V_2^n(T_\epsilon) \cup V_2^g(T_\epsilon)$ and ρ_u^\perp with $u \in V_6(T_\epsilon), \epsilon = \pm$. Note that all these elements act as a reflection in T_ϵ and as the identity in $T_{-\epsilon}$.

Each element of $\text{Aut}^+(\mathbb{L}, \Delta, h, c)$ preserves the eigenspaces T_\pm and hence, group $\text{Aut}^+(\mathbb{L}, \Delta, h, c)$ naturally acts on Ch_+, Ch_- , and $\text{Ch}_+ \times \text{Ch}_-$.

6.2.4. Theorem. *The set of deformation classes of real Zariski sextics of homological type c as well as the set of deformation classes of regular c -real (\mathbb{L}, Δ, h) -marked K3-surfaces are in a natural bijection with the set of orbits of the action of $\text{Aut}^+(\mathbb{L}, \Delta, h, c)$ on $\text{Ch}_+ \times \text{Ch}_-$.*

Proof. Given a real Zariski sextic of homological type c , we replace it by the associated K3-surface \tilde{Y} and equip \tilde{Y} with a real structure conj (lifted from the real structure of P^2) and with a c -real (\mathbb{L}, Δ, h) -marking. Due to Proposition 6.1.1, the sextic can be reconstructed back, up to projective transformation, as the branch curve of the linear system given by h . Furthermore, if we start from a regular c -real (\mathbb{L}, Δ, h) -marked K3-surface Z and apply this reconstruction procedure, the real structure we get on P^2 is the standard one, since all real structures on P^2 are isomorphic to each other. Now, it remains to apply Theorem 6.2.2, Lemma 6.2.3, and the strong Torelli theorem. \square

6.3. Deformation classification via geometric involutions.

6.3.1. Theorem. *For any homological type $c \in C(\mathbb{L}, \Delta, h)$ there is one and only one deformation class of regular c -real (\mathbb{L}, Δ, h) -marked K3-surfaces, as well as one and only one deformation class of real Zariski sextics of homological type c . In particular, the deformation classes of real Zariski sextics are in one-to-one correspondence with the set of conjugacy classes of ascending geometric involutions.*

Let us fix a geometric involution $c \in C(\mathbb{L}, \Delta, h)$.

6.3.2. Proposition. *The action of $\text{Aut}^+(\mathbb{L}, \Delta, h, c)$ on $\text{Ch}_+ \times \text{Ch}_-$ is transitive.*

Proof. Let us analyze how the reflections ρ_v^T for $v \in V(T_\pm)$ can be extended from T_\pm to the whole \mathbb{L} . The extension in case of $v \in V_2(T_\pm)$ is obvious.

6.3.3. Lemma. *For any $v \in V_2(T_\pm)$, the reflection $\rho_v(x) = x - \frac{xv}{v^2}v$ is well-defined on the whole lattice \mathbb{L} , it acts as the identity in S as well as in T_\mp (opposite to T_\pm), and $\rho_v \in \text{Aut}^+(\mathbb{L}, \Delta, h, c)$. \square*

The case of $v \in V_6(T_\pm)$ is a bit more subtle.

6.3.4. Lemma. *For any $v \in V_6(T_\pm)$, the reflection $\rho_v^T|_{T_\pm} : T_\pm \rightarrow T_\pm$ can be extended to an automorphism $f \in \text{Aut}^+(\mathbb{L}, \Delta, h, c)$ that acts on T_\mp as id_{T_\mp} .*

Proof. Note that $\rho_v^T|_{T_\pm}$ induces the identity map in $\text{discr}_2 T_\pm$ and, thus, by Lemma 3.11.1 can be extended to the whole T by gluing with the identity automorphism on T_\mp . Applying Lemma 3.11.1 once more, we extend the result of gluing to an involution $\rho_v^{T'} : T' \rightarrow T'$ that maps h to h . Finally, we extend $\rho_v^{T'}$ to $f : \mathbb{L} \rightarrow \mathbb{L}$ applying Proposition 5.4.5, where we use the c -equivariant Δ -relative epistability of S^0 (see Corollary 5.3.4). To check that $f \in \text{Aut}^+(\mathbb{L}, \Delta, h, c)$ it is left to notice that $\rho_v^T|_{T_\pm}$ preserves the halves of the cones $\{v \in T_\pm \mid v^2 > 0\}$, and therefore f preserves the prescribed orientation of the positive definite real planes in $T_\mathbb{R}$. \square

Proof of Proposition 6.3.2. The reflection group generated by $\rho_v^T, v \in V_2^n(T_\pm) \cup V_2^g(T_\pm) \cup V_6(T_\pm)$, acts transitively on Ch_\pm . Thus, Lemmas 6.3.3 and 6.3.3 imply Proposition 6.3.2. \square

Proof of Theorem 6.3.1. The "only if" part is trivial. The other part follows from Theorem 6.2.4 and Proposition 6.3.2.

6.4. From a trigonal curve in Σ_4 to Zariski sextics in P^2 . With a given geometric ascending involution $c \in C^<(\mathbb{L}, \Delta, h)$ and an element $v \in V_2^h(T_-)$ we associate its *partner involution* c^v that acts in T as a composition of c with reflection against the plane generated by h and v , and in S^0 as a composition of c with the involution permuting the elements of Δ so that the generators in each of the six $A_2 \subset S^0$ are transposed. Then $c^v \in C^<(\mathbb{L}, \Delta, h)$ as well, since by the definition $T_+(c^v) = T_-(c) \cap v^\perp$ and $T_-(c^v) \cap v^\perp = T_+(c)$.

We can peak a c -real (\mathbb{L}, Δ, h) -marked K3-surface Z , whose period point is a generic point of H_v . Then according to Proposition 6.1.4(3), it is a double covering of Σ_4 branched along the union of the (-4) -section and a 6-cuspidal trigonal curve with coplanar cusps. In addition to the real structure in Z inducing involution c in its lattice, there is another one inducing c^v ; the two real structures in Z are the two liftings of a real structure in Σ_4 and differ by the deck transformation of the double covering $Z \rightarrow \Sigma_4$. By real perturbations of (Z, c) and (Z, c^v) we obtain regular K3-surfaces and the deformation types of the corresponding real Zariski sextics do not depend on the choice of perturbations. Hence, we may speak on the well defined partner Z -deformation classes of real Zariski sextics. Below, we make some explicit choice of perturbations, which allows us to compare the partner real Zariski sextics obtained in this way. Namely, we prove that such a pair of real Zariski sextics is placed in $\mathbb{R}P^2$ in a trigonal reverse position (see Section 2.6 for definitions of reverse position, trigonality, and reversion partners).

6.4.1. Proposition. *Real Zariski curves in a pair of partner Z -deformation classes are reversion partners.*

Proof. Consider the weighted projective space $P(2, 1, 1, 1)$ with coordinates q, x, y, z of weights $2, 1, 1, 1$ and the conic B defined by equations $q = 0, Q = 0$ where Q denotes the polynomial $xy - z^2$. Note that the cone over B with vertex at $(1, 0, 0, 0)$ is the ruled surface Σ'_4 (the (-4) section of Σ_4 is contracted here to the vertex of the cone). Note also that due to the isomorphism $P^1 \rightarrow B$ given by $x = u^2, y = v^2, z = uv$ any homogeneous degree $2n$ polynomial $g_{2n}(u, v)$ in

variables u, v can be rewritten as a homogeneous degree n polynomial $f_n(x, y, z)$ in x, y, z (such a presentation is unique modulo the ideal generated by Q).

Now, pick a 6-cuspidal trigonal curve C in Σ'_4 so that all the six cusps belong to the plane $q = 0$ and write a defining polynomial of C as $q^3 + g_4(u, v)q^2 + g_6(u, v)q + g_{12}(u, v)$. Then, express the polynomials g_4, g_6, g_{12} in variables u, v as polynomials f_2, f_4, f_6 in variables x, y, z . This allows us to define $C \subset \Sigma'_4$ by equations

$$q^3 + f_2(x, y, z)q^2 + f_4(x, y, z)q + f_6(x, y, z) = 0, Q = 0,$$

and then include it in a family

$$q^3 + f_2(x, y, z)q^2 + f_4(x, y, z)q + f_6(x, y, z) = 0, Q = tq.$$

Due to the special position of the cusps $q^3 + g_4(u, v)q^2 + g_6(u, v)q + g_{12}(u, v) = q^3 + (g_2(u, v)q + g_6(u, v))^2$, so that $q^3 + f_2(x, y, z)q^2 + f_4(x, y, z)q + f_6(x, y, z) = q^3 + (f_1(x, y, z)q + f_3(x, y, z))^2$.

As a straightforward calculation shows, the associated family of plane curves defined by

$$Q^3 + t(f_1(x, y, z)Q + f_3(x, y, z))^2 = 0$$

is a family of Zariski sextics (with 6 cusps on B) degenerating to $Q^3 = 0$. The double coverings of P^2 branched along these sextics are naturally embedded into the weighted projective space $P(3, 2, 1, 1, 1)$ with coordinates r, q, x, y, z of weights 3, 2, 1, 1, 1 where they become defined by equations

$$r^2 + (q^3 + (f_1(x, y, z)q + f_3(x, y, z))^2) = 0, Q = tq,$$

and thus form a family converging to the double covering of Σ_4 branched along C :

$$r^2 + (q^3 + (f_1(x, y, z)q + f_3(x, y, z))^2) = 0, Q = 0.$$

To get a pair of real Zariski curves in a pair of Z -deformation classes we need to select a pair of Möbius real structures converging to (Z, c) and (Z, c^v) . In other words to select appropriate real forms of the double coverings, namely, to choose an appropriate sign of t and an appropriate sign of r^2 . Such a pair of real forms is given, with respect to the standard real structure on $P(3, 2, 1, 1, 1)$, by

$$r^2 + (q^3 + (f_1(x, y, z)q + f_3(x, y, z))^2) = 0, Q = tq,$$

for $t > 0$ and by

$$r^2 - (q^3 + (f_1(x, y, z)q + f_3(x, y, z))^2) = 0, Q = tq,$$

for $t < 0$. The real Zariski curves $C'_t, t > 0$, of the first family converge to C , while the real Zariski curves $C''_t, t < 0$, of the second one converge to the image C' of C under the reflection $q \mapsto -q$ in the cylindrical part of Σ'_4 , and thus the trigonality and reversion position property from the definition of reversion partners follows from the possibility to trivialize the real part of the surface family over the real locus of the cylindrical part of Σ'_4 . The signs $o(C)$ and $o(C')$ are opposite due to Corollary 4.6.3, while Proposition 4.3.5 implies that C and C' are both of the same type. \square

7. ARITHMETICS OF THE T-PAIRS

7.1. Geography of the ascending T-pairs. We start analysis of the T-halves, M , with reviewing their possible numerical invariants. On the first step, we ignore its 3-primary component and look only at the rank $r(M)$, the discriminant 2-rank $r_2(M)$, and the discriminant parity $\delta_2(M)$. Namely, we prove the following

7.1.1. Lemma. *Assume that (M, M') is an ascending T-pair. Then the combination of the invariants r and r_2 of M is one of the fifteen ones listed in the Table 3A, and the combination of the invariants $r' = 9 - r$, $r'_2 = r_2 + 1$ of M' appears at the corresponding position in Table 3B. The value of δ_2 for M indicated in each row of Table 3A is the only possible value for all the pairs (r, r_2) in this row (for the last row, the both values, 0 and 1, of δ_2 are allowable). The value δ'_2 for M' is 1 for each pair $(r', r_2;)$.*

Table 3A. T-halves M

Table 3B. T-halves M'

| (r, r_2) | δ_2 | (r', r'_2) | δ'_2 |
|----------------------------------|------------|----------------------------------|-------------|
| $(2, 0), (4, 0), (6, 0), (8, 0)$ | 0 | $(7, 1), (5, 1), (3, 1), (1, 1)$ | 1 |
| $(1, 1), (3, 1), (5, 1), (7, 1)$ | 1 | $(8, 2), (6, 2), (4, 2), (2, 2)$ | 1 |
| $(3, 3), (5, 3)$ | 1 | $(6, 4), (4, 4)$ | 1 |
| $(2, 2), (4, 2), (6, 2), (4, 4)$ | 0, 1 | $(7, 3), (5, 3), (3, 3), (5, 5)$ | 1 |

Proof. For T-pairs $1 \leq r, r' \leq 8$, $r + r' = 9$, the ascending condition means $r'_2 = r_2 + 1$, and Lemma 4.9.1 yields $r_2 \leq \min(r, r' - 1)$. Together with the congruence $r_2 = r \pmod 2$ (see Lemma 3.4.3), these restrictions forbid all the cases except the fourteen ones listed in the Tables 3A-B.

The value $\delta'_2 = 1$ follows from the definition of ascending T-pairs in 5.10 (property (4) in Lemma 4.8.1). For the values of δ_2 in Table 3A note that for $r_2 = 0$ we have $\text{discr}_2 M = 0$, and thus $\delta_2 = 0$. On the other hand, for odd values of r_2 , we have $\delta_2 = 0$, see Proposition 3.6.3(1). \square

Now, for each combination of values r, r_2, δ_2 from Table 3A-B we will finalize the enumeration of the IDs by giving possible values of (p, q) describing the discriminant 3-component, $\text{discr}_3 M = p\langle \frac{2}{3} \rangle + q\langle -\frac{2}{3} \rangle$. Namely, we prove the following.

7.1.2. Proposition. *Assume that (M, M') is an ascending T-pair. Then the combination of the invariants r, r_2, δ_2, p, q for M and the corresponding invariants $r' = 9 - r, r'_2 = r_2 + 1, p' = 1 - p, q' = 3 - q$ for M' (recall that $\delta'_2 = 1$) is contained in one or the rows of Table 4 (the matching values of (p, q) and (p', q') appear in the corresponding positions of that row).*

The proof is based on the following relations.

7.1.3. Proposition. *Assume that lattice L is even, the discriminant p -ranks r_p vanish for all $p \neq 2, 3$, and the primary components $\text{discr}_p(L)$ for $p = 2$ and $p = 3$ are elementary. Let $\sigma \in \mathbb{Z}$ denote the signature of L , $\delta_2 \in \{0, 1\}$ the parity of $\text{discr}_2 L$, and Br_3 the Brown invariant of $\text{discr}_3 L$. Then*

- (1) $r_2 = 0$ implies that $\text{Br}_3 = \sigma \pmod 8$;
- (2) $r_2 = 1$ implies that $|\text{Br}_3 - \sigma| = 1 \pmod 8$;
- (3) $r_2 = 2$ together with $|\text{Br}_3 - \sigma| = 4 \pmod 8$ imply that $\delta_2 = 0$;
- (4) $\delta_2 = 0$ implies that r_2 is even and $\text{Br}_3 = \sigma \pmod 4$.
- (5) $r_2 = r$ together with $\delta_2 = 0$ imply that $\text{Br}_3 = -\sigma \pmod 8$;
- (6) $r_3 = r$ implies that $\text{Br}_3 = 2\sigma \pmod 8$.

Proof. The Brown invariant Br_2 of $\text{discr}_2 L$ can be expressed as the modulo 8 residue of $\sigma - \text{Br}_3$, by the van der Blij theorem (see Corollary 3.7.4). Since $\text{Br}_2 = 0$ for $r_2 = 0$, this implies (1). If $r_2 = 1$, then $\text{Br}_2 = \pm 1$ (see Example 3.6.1), which implies (2). The case of $r_2 = 2$ with $\delta_2 = 0$ is considered in the Example 3.6.2, it yields (3). Proposition 3.6.3(1) yields (4).

If $r_2 = r$, then L is divisible by 2 (see Proposition 3.4.1), moreover the condition $\delta_2 = 0$ implies that division by 2 yields an even lattice $L' = L(\frac{1}{2})$. Moreover, parts (2) and (3) of Proposition

Table 4.

| δ_2 | (r, r_2) | (p, q) | (r', r'_2) | (p', q') |
|------------|------------|--|--------------|--|
| 0 | (2, 0) | (0, 0), (1, 1) | (7, 1) | (1, 3), (0, 2) |
| 0 | (4, 0) | (0, 1), (1, 2) | (5, 1) | (1, 2), (0, 1) |
| 0 | (6, 0) | (0, 2), (1, 3) | (3, 1) | (1, 1), (0, 0) |
| 0 | (8, 0) | (0, 3) | (1, 1) | (1, 0) |
| 1 | (1, 1) | (0, 0), (1, 0) | (8, 2) | (1, 3), (0, 3) |
| 1 | (3, 1) | (0, 0), (0, 1), (1, 1), (1, 2) | (6, 2) | (1, 3), (1, 2), (0, 2), (0, 1) |
| 1 | (5, 1) | (0, 1), (0, 2), (1, 2), (1, 3) | (4, 2) | (1, 2), (1, 1), (0, 1), (0, 0) |
| 1 | (7, 1) | (0, 2), (0, 3), (1, 3) | (2, 2) | (1, 1), (1, 0), (0, 0) |
| 0, 1 | (2, 2) | (0, 0), (1, 1) | (7, 3) | (1, 3), (0, 2) |
| 1 | (2, 2) | (0, 1), (1, 0) | (7, 3) | (1, 2), (0, 3) |
| 0 | (4, 2) | (0, 3), (1, 0) | (5, 3) | (1, 0), (0, 3) |
| 0, 1 | (4, 2) | (0, 1), (1, 2) | (5, 3) | (1, 2), (0, 1) |
| 1 | (4, 2) | (0, 0), (0, 2), (1, 1), (1, 3) | (5, 3) | (1, 3), (1, 1), (0, 2), (0, 0) |
| 0 | (6, 2) | (1, 1) | (3, 3) | (0, 2) |
| 0, 1 | (6, 2) | (0, 2), (1, 3) | (3, 3) | (1, 1), (0, 0) |
| 1 | (6, 2) | (0, 1), (0, 3), (1, 2) | (3, 3) | (1, 2), (1, 0), (0, 1) |
| 1 | (3, 3) | (0, 0), (0, 1), (0, 2), (1, 0), (1, 1), (1, 2) | (6, 4) | (1, 3), (1, 2), (1, 1), (0, 3), (0, 2), (0, 1) |
| 1 | (5, 3) | any $p \leq 1, q \leq 3$ | (4, 4) | $p' = 1 - p, q' = 3 - q$ |
| 0, 1 | (4, 4) | (0, 3), (1, 0) | (5, 5) | (1, 0), (0, 3) |
| 1 | (4, 4) | (0, 0), (0, 1), (0, 2), (1, 1), (1, 2), (1, 3) | (5, 5) | (1, 3), (1, 2), (1, 1), (0, 2), (0, 1), (0, 0) |

3.4.1 imply that $\text{discr } L'$ is anti-isomorphic to $\text{discr}_3 L$, and thus, $\text{Br}(L') = -\text{Br}_3(L)$. Applying the van der Blij theorem to L' , we obtain $\text{Br}(L') = \sigma \pmod{8}$, and thus $\text{Br}_3(L) = -\sigma$, and applying it to L , we get $\text{Br}(L) = \text{Br}_2(L) + \text{Br}_3(L) = \sigma \pmod{8}$, and thus, $\text{Br}_2(L) = 2\sigma \pmod{8}$, which yields (5).

If $r_3 = r$, then L is divisible by 3 and $L' = L(\frac{1}{3})$ is an even lattice whose discriminant $\text{discr } L' = \text{discr}_2 L'$ (again, due to Proposition 3.4.1) is anti-isomorphic to $\text{discr}_2 L$. Like in the previous case, applying van der Blij's theorem to L' and L we obtain $\text{Br}(L') = -\text{Br}_2(L) = \sigma \pmod{8}$, and $\text{Br}(L) = \text{Br}_2(L) + \text{Br}_3(L) = \sigma \pmod{8}$, which yields (6). \square

7.1.4. Corollary. *Assume that M is an T -half of rank r , 2-rank r_2 , and $\text{discr}_3 M = p\langle\frac{2}{3}\rangle + q\langle-\frac{2}{3}\rangle$. Then*

- (1) if $r_2 = 0$, then $q - p = \frac{r}{2} - 1 \pmod{4}$;
- (2) if $r_2 = 1$, then $q - p = \frac{r \pm 1}{2} - 1 \pmod{4}$;
- (3) if $r_2 = 2$ and $q - p = \frac{r}{2} + 1 \pmod{4}$, then $\delta_2 = 0$;
- (4) if $\delta_2 = 0$, then $r = r_2 = 0 \pmod{2}$ and $q - p = \frac{r}{2} - 1 \pmod{2}$;
- (5) if $r_2 = r$ and $\delta_2 = 0$, then $p - q = \frac{r}{2} - 1 \pmod{4}$;
- (6) if $r_3 = r$, then $q - p = r - 2 \pmod{4}$;
- (7) $r \leq r_3 = p + q$.

Proof. (1)–(6) follows from Proposition 7.1.3, since for T -halves $\text{Br}_3 = 2(p - q) \pmod{8}$ and $\sigma = 2 - r$. (7) follows from Proposition 3.4.1. \square \square

Proof of Proposition 7.1.2. It follows from the definition of T -halves M (see Lemma 4.8.1(5)) and classification of the elementary 3-group (see Lemma 3.7.2) that $\text{discr}_3 M = p\langle\frac{2}{3}\rangle + q\langle-\frac{2}{3}\rangle$, where $0 \leq p \leq 1$ and $0 \leq q \leq 3$. For each combination of (r, r_2) and δ_2 from Table 3A, we included in Table 4 those pairs (p, q) which are not forbidden by one of the restrictions of Corollary 7.1.4 applied to M and M' .

Remark. In a few cases Corollary 7.1.4 does not forbid a combination of δ_2, r, r_2, p , and q , but forbids the complementary combination (i.e., for the other T -half of an T -pair). For instance,

the case $(r, r_2) = (7, 1)$, $(p, q) = (1, 0)$ is not forbidden, and is in fact realizable for the lattice $\langle 2 \rangle + \mathbb{E}_6$. However, the complementary lattice would have $r' = 2$ and $(p', q') = (0, 3)$, which is forbidden, since $r' < r'_3 = 3$. Thus, the combination $(r, r_2) = (7, 1)$, $(p, q) = (1, 0)$ is excluded from the list.

7.2. The list of T-halves. Below we provide an example of a T-half for every combinations of the numerical invariants from Table 4 (verification is straightforward).

7.2.1. Proposition. *For every combination of invariants r, r_2, δ_2, p, q , or $r', r'_2, \delta'_2 = 1, p', q'$ listed in the Table 4, there exists a T-half with such invariants. Namely, such a lattice can be found in Tables 5A-J. \square*

Tables 5A-J contain only T-halves. Sign “ \cdot ” signifies that a lattice with given invariants is forbidden by Corollary 7.1.4. Sign “ $*$ ” stands if a lattice actually exists, but it is not a T-half, because the complementary lattice is forbidden.

Table 5A. $r_2 = 0$ and $p = 0$

| (r, r_2) | $q = 0$ | $q = 1$ | $q = 2$ | $q = 3$ |
|------------|--------------|-----------------------------|------------------------------|------------------------------|
| (2, 0) | \mathbb{U} | – | – | – |
| (4, 0) | – | $\mathbb{U} + \mathbb{A}_2$ | – | – |
| (6, 0) | – | – | $\mathbb{U} + 2\mathbb{A}_2$ | – |
| (8, 0) | – | – | – | $\mathbb{U} + 3\mathbb{A}_2$ |

Table 5B. $r_2 = 0$ and $p = 1$

| $q = 0$ | $q = 1$ | $q = 2$ | $q = 3$ |
|-----------------------------|-----------------|--------------------------------|---------------------------------|
| – | $\mathbb{U}(3)$ | – | – |
| – | – | $\mathbb{U}(3) + \mathbb{A}_2$ | – |
| – | – | – | $\mathbb{U}(3) + 2\mathbb{A}_2$ |
| $\mathbb{U} + \mathbb{E}_6$ | – | – | – |

Table 5C. $r_2 = 1$ and $p=0$

| (r, r_2) | $q = 0$ | $q = 1$ | $q = 2$ | $q = 3$ |
|------------|-----------------------------|--|---|-------------------------------------|
| (1, 1) | $\langle 2 \rangle$ | – | – | – |
| (3, 1) | $\mathbb{U} + \mathbb{A}_1$ | $\langle 2 \rangle + \mathbb{A}_2$ | – | – |
| (5, 1) | – | $\mathbb{U} + \mathbb{A}_2 + \mathbb{A}_1$ | $\langle 2 \rangle + 2\mathbb{A}_2$ | – |
| (7, 1) | – | – | $\mathbb{U} + 2\mathbb{A}_2 + \mathbb{A}_1$ | $\langle 2 \rangle + 3\mathbb{A}_2$ |

Table 5D. $r_2 = 1$ and $p=1$

| $q = 0$ | $q = 1$ | $q = 2$ | $q = 3$ |
|---------------------|------------------------------------|--------------------------------------|---|
| $\langle 6 \rangle$ | – | – | – |
| – | $\langle 6 \rangle + \mathbb{A}_2$ | $\mathbb{U}(3) + \langle -6 \rangle$ | – |
| – | – | $\langle 6 \rangle + 2\mathbb{A}_2$ | $\mathbb{U}(3) + \mathbb{A}_2 + \langle -6 \rangle$ |
| $*$ | – | – | $\langle 6 \rangle + 3\mathbb{A}_2$ |

Table 5E. $r_2 = 2$ and $p=0$

| δ_2 | (r, r_2) | $q = 0$ | $q = 1$ | $q = 2$ | $q = 3$ |
|------------|------------|------------------------------------|--|---|--|
| 0 | (2, 2) | $\mathbb{U}(2)$ | – | – | – |
| 1 | (2, 2) | $\langle 2 \rangle + \mathbb{A}_1$ | $\langle 2 \rangle + \langle -6 \rangle$ | – | – |
| 0 | (4, 2) | – | $\mathbb{U}(2) + \mathbb{A}_2$ | – | $\mathbb{U}(3) + \mathbb{A}_2(2)$ |
| 1 | (4, 2) | $\mathbb{U} + 2\mathbb{A}_1$ | $\mathbb{U} + \mathbb{A}_1 + \langle -6 \rangle$ | $\mathbb{U} + 2\langle -6 \rangle$ | – |
| 0 | (6, 2) | $*$ | – | $\mathbb{U}(2) + 2\mathbb{A}_2$ | – |
| 1 | (6, 2) | – | $\mathbb{U} + \mathbb{A}_2 + 2\mathbb{A}_1$ | $\mathbb{U} + \mathbb{A}_2 + \langle -6 \rangle + \mathbb{A}_1$ | $\mathbb{U} + \mathbb{A}_2 + 2\langle -6 \rangle$ |
| 1 | (8, 2) | – | – | $*$ | $\langle 2 \rangle + 3\mathbb{A}_2 + \mathbb{A}_1$ |

Table 5F. $r_2 = 2$ and $p=1$

| δ_2 | (r, r_2) | $q = 0$ | $q = 1$ | $q = 2$ | $q = 3$ |
|------------|------------|------------------------------------|--|---|--|
| 0 | (2, 2) | – | $\mathbb{U}(6)$ | – | – |
| 1 | (2, 2) | $\langle 6 \rangle + \mathbb{A}_1$ | $\langle 6 \rangle + \langle -6 \rangle$ | – | – |
| 0 | (4, 2) | $\mathbb{U} + \mathbb{A}_2(2)$ | – | $\mathbb{U}(6) + \mathbb{A}_2$ | – |
| 1 | (4, 2) | – | $\mathbb{U}(3) + 2\mathbb{A}_1$ | $\mathbb{U}(3) + \mathbb{A}_1 + \langle -6 \rangle$ | $\mathbb{U}(3) + 2\langle -6 \rangle$ |
| 0 | (6, 2) | – | $\mathbb{U}(3) + \mathbb{D}_4$ | – | $\mathbb{U}(6) + 2\mathbb{A}_2$ |
| 1 | (6, 2) | $*$ | – | $\mathbb{U}(3) + \mathbb{A}_2 + 2\mathbb{A}_1$ | $\mathbb{U}(3) + \mathbb{A}_2 + \mathbb{A}_1 + \langle -6 \rangle$ |
| 1 | (8, 2) | $*$ | $*$ | – | $\mathbb{U}(3) + 2\mathbb{A}_2 + 2\mathbb{A}_1$ |

Table 5G. $r_2 = 3$, or $r_2 = 5$ and $p=0$

| (r, r_2) | $q = 0$ | $q = 1$ | $q = 2$ | $q = 3$ |
|------------|-------------------------------------|---|--|--|
| (3, 3) | $\langle 2 \rangle + 2\mathbb{A}_1$ | $\langle 2 \rangle + \mathbb{A}_1 + \langle -6 \rangle$ | $\langle 2 \rangle + 2\langle -6 \rangle$ | – |
| (5, 3) | $\mathbb{U} + 3\mathbb{A}_1$ | $\mathbb{U} + 2\mathbb{A}_1 + \langle -6 \rangle$ | $\mathbb{U} + \mathbb{A}_1 + 2\langle -6 \rangle$ | $\mathbb{U} + 3\langle -6 \rangle$ |
| (5, 5) | $\mathbb{U}(2) + 3\mathbb{A}_1$ | $\mathbb{U}(2) + 2\mathbb{A}_1 + \langle -6 \rangle$ | $\mathbb{U}(2) + \mathbb{A}_1 + 2\langle -6 \rangle$ | $\mathbb{U}(2) + 3\langle -6 \rangle$ |
| (7, 3) | $*$ | $*$ | $\mathbb{U} + \mathbb{A}_2 + \langle -6 \rangle + 2\mathbb{A}_1$ | $\mathbb{U} + \mathbb{A}_2 + 2\langle -6 \rangle + \mathbb{A}_1$ |

Table 5H. $r_2 = 3$, or $r_2 = 5$ and $p=1$

| (r, r_2) | $q = 0$ | $q = 1$ | $q = 2$ | $q = 3$ |
|------------|-------------------------------------|---|--|---|
| (3, 3) | $\langle 6 \rangle + 2\mathbb{A}_1$ | $\langle 6 \rangle + \mathbb{A}_1 + \langle -6 \rangle$ | $\langle 6 \rangle + 2\langle -6 \rangle$ | — |
| (5, 3) | $\langle 6 \rangle + \mathbb{D}_4$ | $\mathbb{U}(3) + 3\mathbb{A}_1$ | $\mathbb{U}(3) + 2\mathbb{A}_1 + \langle -6 \rangle$ | $\mathbb{U}(3) + \mathbb{A}_1 + 2\langle -6 \rangle$ |
| (5, 5) | $\langle 6 \rangle + 4\mathbb{A}_1$ | $\mathbb{U}(6) + 3\mathbb{A}_1$ | $\mathbb{U}(6) + 2\mathbb{A}_1 + \langle -6 \rangle$ | $\mathbb{U}(6) + \mathbb{A}_1 + 2\langle -6 \rangle$ |
| (7, 3) | * | * | $\mathbb{U}(3) + \mathbb{A}_2 + 3\mathbb{A}_1$ | $\mathbb{U}(3) + \mathbb{A}_2 + \langle -6 \rangle + 2\mathbb{A}_1$ |

Table 5I. $r_2 = 4$ and $p=0$

| δ_2 | (r, r_2) | $q = 0$ | $q = 1$ | $q = 2$ | $q = 3$ |
|------------|------------|-------------------------------------|--|--|---|
| 0 | (4, 4) | — | — | — | $\mathbb{U}(6) + \mathbb{A}_2(2)$ |
| 1 | (4, 4) | $\langle 2 \rangle + 3\mathbb{A}_1$ | $\langle 2 \rangle + 2\mathbb{A}_1 + \langle -6 \rangle$ | $\langle 2 \rangle + \mathbb{A}_1 + 2\langle -6 \rangle$ | $\langle 2 \rangle + 3\langle -6 \rangle$ |
| 1 | (6, 4) | * | $\mathbb{U} + \langle -6 \rangle + 3\mathbb{A}_1$ | $\mathbb{U} + 2\langle -6 \rangle + \mathbb{A}_1$ | $\mathbb{U} + 3\langle -6 \rangle + \mathbb{A}_1$ |

Table 5J. $r_2 = 4$ and $p=1$

| δ_2 | (r, r_2) | $q = 0$ | $q = 1$ | $q = 2$ | $q = 3$ |
|------------|------------|-------------------------------------|--|--|---|
| 0 | (4, 4) | $\mathbb{U}(2) + \mathbb{A}_2(2)$ | — | — | — |
| 1 | (4, 4) | $\langle 6 \rangle + 3\mathbb{A}_1$ | $\langle 6 \rangle + \langle -6 \rangle + 2\mathbb{A}_1$ | $\langle 6 \rangle + 2\langle -6 \rangle + \mathbb{A}_1$ | $\langle 6 \rangle + 3\langle -6 \rangle$ |
| 1 | (6, 4) | * | $\mathbb{U}(3) + 4\mathbb{A}_1$ | $\mathbb{U}(3) + \langle -6 \rangle + 3\mathbb{A}_1$ | $\mathbb{U}(3) + 2\langle -6 \rangle + 2\mathbb{A}_1$ |

Remark. Note that there is some ambiguity in the direct sum presentations of the lattices in the above tables, due to the following isomorphisms: $\langle 6 \rangle + \mathbb{A}_2 = \mathbb{U}(3) + \mathbb{A}_1$, $\langle 2 \rangle + \mathbb{A}_2 = \mathbb{U} + \langle -6 \rangle$, $\langle 6 \rangle + \mathbb{A}_2(2) = \langle 2 \rangle + 2\langle -6 \rangle$, $\langle 2 \rangle + \mathbb{A}_2(2) = \langle 6 \rangle + 2\mathbb{A}_1$.

Besides, for any lattice L with an odd $\text{discr}_2 L$ (for instance, $L = \mathbb{A}_1$, or $L = \langle -6 \rangle$) we have $\mathbb{U}(2) + L = \langle 2 \rangle + \mathbb{A}_1 + L$, and $\mathbb{U}(6) + L = \langle 6 \rangle + \langle -6 \rangle + L$.

7.3. Stability of the T-halves. Our aim in the next four subsections is to prove stability of the T-halves, and thus, to show that their list in Tables 5A–J is complete.

It is easy to check which of these lattices do not satisfy Nikulin's stability criterion (see 3.12.1) using Table 4. We see from it that Nikulin's condition for r_2 , namely, $r > r_2$, or $r = r_2 > 2$, fails only for the T-halves listed in Table 6A below. Table 6B contains the remaining cases, in which Nikulin's condition $r_3 \leq r - 2$ fails.

7.3.1. Lemma. *For any T-pair (T_1, T_2) , Nikulin's stability criterion 3.12.1 is satisfied for T_i , $i \in \{1, 2\}$, unless the combination of the invariants $r(T_i)$, $r_2(T_i)$, $\delta_2(T_i)$, $p(T_i)$ and $q(T_i)$ is among the ones listed in Tables 6A–B. \square*

Table 6A. $r_2 = r \leq 2$

| δ_2 | (r, r_2) | (p, q) | T_i |
|------------|------------|----------|--|
| 1 | 1 | (1, 1) | $\langle 2 \rangle$ |
| 2 | 1 | (1, 1) | $\langle 6 \rangle$ |
| 3 | 0 | (2, 2) | $\mathbb{U}(2)$ |
| 4 | 0 | (2, 2) | $\mathbb{U}(6)$ |
| 5 | 1 | (2, 2) | $\langle 2 \rangle + \mathbb{A}_1$ |
| 6 | 1 | (2, 2) | $\langle 2 \rangle + \langle -6 \rangle$ |
| 7 | 1 | (2, 2) | $\langle 6 \rangle + \mathbb{A}_1$ |
| 8 | 1 | (2, 2) | $\langle 6 \rangle + \langle -6 \rangle$ |

7.3.2. Corollary. *For any T-pair (T_1, T_2) either T_1 or T_2 satisfies Nikulin's stability condition.*

Proof. It can be easily seen from Table 4, that there is no pairs (T_1, T_2) , for which both T_1 and T_2 are represented in the above list of exceptions. \square

7.4. Simplest cases. The following fact is well known.

Table 6B. $r_3 \geq r - 1$

| | δ_2 | (r, r_2) | (p, q) | T_i | | |
|----|------------|------------|----------|--|---------------|-----------|
| 1 | 0 | (2, 0) | (1, 1) | $\mathbb{U}(3)$ | $r_3 = r$ | $r_2 = 0$ |
| 2 | 0 | (4, 0) | (1, 2) | $\mathbb{U}(3) + \mathbb{A}_2$ | $r_3 = r - 1$ | $r_2 = 0$ |
| 3 | 1 | (3, 1) | (1, 1) | $\mathbb{U}(3) + \mathbb{A}_1$ | $r_3 = r - 1$ | $r_2 < r$ |
| 4 | 1 | (3, 1) | (1, 2) | $\mathbb{U}(3) + \langle -6 \rangle$ | $r_3 = r$ | $r_2 < r$ |
| 5 | 1 | (5, 1) | (1, 3) | $\mathbb{U}(3) + \mathbb{A}_2 + \langle -6 \rangle$ | $r_3 = r - 1$ | $r_2 < r$ |
| 6 | 0 | (4, 2) | (0, 3) | $\mathbb{U}(3) + \mathbb{A}_2(2)$ | $r_3 = r - 1$ | $r_2 < r$ |
| 7 | 0 | (4, 2) | (1, 2) | $\mathbb{U}(6) + \mathbb{A}_2$ | $r_3 = r - 1$ | $r_2 < r$ |
| 8 | 1 | (4, 2) | (1, 2) | $\mathbb{U}(3) + \mathbb{A}_1 + \langle -6 \rangle$ | $r_3 = r - 1$ | $r_2 < r$ |
| 9 | 1 | (4, 2) | (1, 3) | $\mathbb{U}(3) + 2\langle -6 \rangle$ | $r_3 = r$ | $r_2 < r$ |
| 10 | 1 | (3, 3) | (0, 2) | $\langle 2 \rangle + 2\langle -6 \rangle$ | $r_3 = r - 1$ | $r_2 = r$ |
| 11 | 1 | (3, 3) | (1, 1) | $\langle 6 \rangle + \mathbb{A}_1 + \langle -6 \rangle$ | $r_3 = r - 1$ | $r_2 = r$ |
| 12 | 1 | (3, 3) | (1, 2) | $\langle 6 \rangle + 2\langle -6 \rangle$ | $r_3 = r$ | $r_2 = r$ |
| 13 | 1 | (5, 3) | (1, 3) | $\mathbb{U}(3) + \mathbb{A}_1 + 2\langle -6 \rangle$ | $r_3 = r - 1$ | $r_2 < r$ |
| 14 | 0 | (4, 4) | (0, 3) | $\mathbb{U}(6) + \mathbb{A}_2(2)$ | $r_3 = r - 1$ | $r_2 = r$ |
| 15 | 1 | (4, 4) | (0, 3) | $\langle 2 \rangle + 3\langle -6 \rangle$ | $r_3 = r - 1$ | $r_2 = r$ |
| 16 | 1 | (4, 4) | (1, 2) | $\langle 6 \rangle + \mathbb{A}_1 + 2\langle -6 \rangle$ | $r_3 = r - 1$ | $r_2 = r$ |
| 17 | 1 | (4, 4) | (1, 3) | $\langle 6 \rangle + 3\langle -6 \rangle$ | $r_3 = r$ | $r_2 = r$ |
| 18 | 1 | (5, 5) | (1, 3) | $\mathbb{U}(6) + \mathbb{A}_1 + 2\langle -6 \rangle$ | $r_3 = r - 1$ | $r_2 = r$ |

7.4.1. Lemma. *The only unimodular hyperbolic lattices of rank ≤ 8 are \mathbb{U} and $\langle 1 \rangle + n\langle -1 \rangle$, $n \leq 7$. \square*

In the following Lemmas we assume that L is a T-half of rank r and p -primary ranks r_p , $p = 2, 3$.

7.4.2. Lemma.

- (1) *If $r_2 = 0$, and $r_3 = r$, then $L = \mathbb{U}(3)$.*
- (2) *If $r_2 = r$, and $r_3 = 0$, then either $\delta_2 = 0$ and $L = \mathbb{U}(2)$, or $\delta_2 = 1$ and $L = \langle 2 \rangle + n\langle -2 \rangle$, $n \leq 7$.*
- (3) *If $r_2 = r_3 = r$, then either $\delta_2 = 0$ and $L = \mathbb{U}(6)$, or $\delta_2 = 1$ and $L = \langle 6 \rangle + n\langle -6 \rangle$, $n \leq 7$.*

Proof. It is enough to apply Proposition 4.9.2 and Lemma 7.4.1 to $L(\frac{1}{3})$, $L(\frac{1}{2})$, $L(\frac{1}{6})$, in the cases (1), (2), and (3) respectively. \square

7.4.3. Lemma. *Under the assumption of Lemma 7.4.2, if $r_3 = r$ and $r_2 < r$, then L is stable.*

Proof. By Nikulin's criterion, $L(\frac{1}{3})$ is stable, thus, L is stable. \square

7.4.4. Lemma. *Under the assumption of Lemma 7.4.2, if $r_2 = r = 2$ and $r_3 = 1$, then L is either $\langle 2 \rangle + \langle -6 \rangle$, or $\langle 6 \rangle + \langle -2 \rangle$.*

Proof. The lattice $L' = L(\frac{1}{2})$ has discriminant order $|\text{discr } L'| = 3$. Fixing any basis of L , we can present it by a matrix, $\begin{pmatrix} a & b \\ b & c \end{pmatrix}$, $ac - b^2 = -3$, (the sign of the discriminant is due to that L is indefinite). The gaussian theory of normal forms says that in a suitable basis this matrix has $0 \leq b \leq \sqrt{3}$, i.e., $b = 0$, or $b = 1$. If $b = 1$, then $ac = b^2 - 3 = -2$, and the only solutions (up to reordering the basis) are $\begin{pmatrix} \pm 1 & 1 \\ 1 & \mp 2 \end{pmatrix}$ and it is easy to check that the both matrices are diagonalizable. Diagonalization yields $\begin{pmatrix} \pm 3 & 0 \\ 0 & \mp 1 \end{pmatrix}$, that is $\langle 1 \rangle + \langle -3 \rangle$, or $\langle 3 \rangle + \langle -1 \rangle$. \square

7.4.5. Corollary. *The lattices of Table 6A and the lattices of Table 6B having $r_3 = r$, namely, the ones in rows 1,4,9,12, and 17, are all stable.*

Proof. Lattices of Table 6A satisfy either assumptions (2)–(3) of Lemma 7.4.2, or the ones of Lemma 7.4.4. For the indicated lattices of Table 6B we apply Lemma 7.4.3. \square

7.5. The case of $r_2 = r$, $r_3 = r - 1$. The case $r \leq 2$ was considered in the previous Subsection, so we assume in what follows that $r \geq 3$.

7.5.1. Proposition. *Let L be a hyperbolic even lattice of rank $r \geq 3$. Assume that L has only discriminant factors 2 and 3, and that the both factors are elementary. Then L is stable if $r_2 = r$ and $r_3 = r - 1$.*

Proof. By Proposition 3.4.1, the lattice L is divisible by 2 and lattice $L' = L(\frac{1}{2})$ has discriminant $\text{discr}(L') = \text{discr}_3(L')$ isomorphic as a group to $\text{discr}_3(L)$.

By Lemma 3.4.2, $M = L'_{(3)} = \{x \in L' \mid xL' \subset 3\mathbb{Z}\}$ is an index 3 sublattice of L' , and $M' = M(\frac{1}{3})$ is an integral lattice whose discriminant is of order 3. This auxiliary lattice M' has the following properties.

7.5.2. Lemma.

- (1) M' is odd if and only if $\delta_2(L) = 1$.
- (2) If M' is odd, then it is isomorphic either to $\langle 3 \rangle + k\langle -1 \rangle$, where $k = r - 1$, or to $\langle 1 \rangle + \langle -3 \rangle + k\langle -1 \rangle$, where $k = r - 2$.
- (3) If M' is even, then r is divisible by 4, and M' is isomorphic either to $\mathbb{U} + \mathbb{A}_2 + k\mathbb{E}_8$ (if $r = 8k + 4$), or to $\mathbb{U} + \mathbb{E}_6 + k\mathbb{E}_8$ (if $r = 8(k + 1)$).

Proof. First, note that M' is odd if and only if M is odd, (since $(3x)^2 = x^2 \pmod{2}$), and that M is odd if and only if L' is odd (since $x \in L'$ implies $3x \in M$). Next, it follows from the definition that L' is odd if and only if \mathfrak{q}_L restricted to $\text{discr}_2(L)$ is not integer, which yields (1).

Part (2) follows from diagonalizability of all the indefinite odd lattices whose discriminant is of order ± 3 (see, for example, [J]). It can be also proved directly by embedding M' into an unimodular lattice N with $|\sigma(N)| = \text{rank}(N) - 4$ (cf., [Kh1] Lemma 2.3) and using then transitivity of automorphisms on primitive elements of the same type and same square (see [W2]).

Assume, now, that M' is even. We can write $\text{discr}_3 M' = p\langle \frac{2}{3} \rangle + q\langle -\frac{2}{3} \rangle$, where (p, q) is either $(1, 0)$, or $(0, 1)$, since $r_3(M') = 1$. Applying Proposition 7.1.3(1) to M' we get $\text{Br}_3(M') = 2(p - q) = \sigma(M') = 2 - r \pmod{8}$, so, $r = 2(1 - p + q) \pmod{8}$ is divisible by 4, and moreover, (p, q) has to be $(1, 0)$ if r is divisible by 8, and $(0, 1)$ if $r = 8k + 4$. In our case, $r \geq 3 = r_3(M') + 2$, so Nikulin's stability criterion is applicable to M' , thus, this lattice must be isomorphic to $\mathbb{U} + \mathbb{A}_2 + k\mathbb{E}_8$, or to $\mathbb{U} + \mathbb{E}_6 + k\mathbb{E}_8$ in the cases $(p, q) = (0, 1)$ and $(p, q) = (1, 0)$ respectively, because in the both cases the ranks and the discriminants are as required. \square

Now let us show that M determines its extension L' (and thus, determines L) uniquely up to isomorphism. In the case $\delta_2(L) = 1$, it follows from Lemma 7.5.2 that M is either $\langle 9 \rangle + (r - 1)\langle -3 \rangle$, or $\langle 3 \rangle + \langle -9 \rangle + (r - 2)\langle -3 \rangle$, the both cases are included in a wider class of lattices $\langle \pm 9 \rangle + \langle \pm 3 \rangle + \dots$, with repeated summands $\langle \pm 3 \rangle$, where the signs \pm can vary independently.

7.5.3. Lemma. *If $A = \langle \pm 9 \rangle + \langle \pm 3 \rangle + \dots$, with $(r - 1)$ summands $\langle 3 \rangle$ or $\langle -3 \rangle$, then there exists a unique extension $B \supset A$ of index 3, such that $\text{discr}_3 B$ does not contain 9-torsion, namely, $B = \langle \pm 1 \rangle + \langle \pm 3 \rangle + \dots$.*

Proof. By Lemma 3.8.2, B is determined by an isotropic subgroup $H \subset \text{discr} A = \langle \pm \frac{1}{9} \rangle + \langle \pm \frac{1}{3} \rangle + \dots$ of order 3, such that H^\perp/H has exponent 3. Let us present a generator, $h \in H$, as $h = u + v$,

$u \in \langle \pm \frac{1}{9} \rangle$, $v \in \langle \pm \frac{1}{3} \rangle + \dots$. Since $v^2 \in \{0, \frac{1}{3}, -\frac{1}{3}\}$ for all elements $v \in \langle \pm \frac{1}{3} \rangle + \dots$, we have $u^2 = -v^2 \in \{0, \frac{1}{3}, -\frac{1}{3}\}$, which implies that u is not a generator of $\langle \pm \frac{1}{9} \rangle$ and thus, $u^2 = v^2 = 0$.

If $v = 0$, then $H \subset \langle \pm \frac{1}{9} \rangle$ defines $B = \langle \pm 1 \rangle + \langle \pm 3 \rangle + \dots$, and thus it remains to show that it is the only case (under the assumption on 9-torsion).

If $u = 0$, then any generator $g \in \langle \pm \frac{1}{9} \rangle$ is an order 9 element in H^\perp/H . In the remaining case $u \neq 0$, $v \neq 0$, we choose an order 9 element $g + t$ so that $(g + t)(u + v) = gu + tv = 0$; namely, we choose element t in a $\langle \pm \frac{1}{3} \rangle$ -summand containing a non-vanishing component of v , so that $tv = -gu$ (note that $gu \in \{\pm \frac{1}{3}\}$). The coset $[g + t] \in H^\perp/H$ has order 9, since $k(g + t) \in H = \{0, \pm(u + v)\}$ for $1 \leq k \leq 8$ implies that k is 3 or 6, which in its turn implies $k(g + t) = kg \notin H$. \square

In the case $\delta_2(L) = 0$, Lemma 7.5.2 shows that M is either $\mathbb{U}(3) + \mathbb{A}_2(3) + k\mathbb{E}_8(3)$, or $\mathbb{U}(3) + \mathbb{E}_6(3) + k\mathbb{E}_8(3)$.

The proof of uniqueness of extensions of index 3 containing no 9-torsion in the discriminant is analogous to that of Lemma 7.5.3. For instance, for $M = \mathbb{U}(3) + \mathbb{A}_2(3) + k\mathbb{E}_8(3)$, we have $\text{discr } M = \langle \frac{2}{3} \rangle + \langle -\frac{2}{3} \rangle + \left(\begin{smallmatrix} -\frac{2}{9} & \frac{1}{3} \\ \frac{1}{3} & -\frac{2}{3} \end{smallmatrix} \right) + 8k\langle -\frac{2}{3} \rangle$. The extension in question is given, indeed, by the isotropic subgroup $H \subset \text{discr } M$ of order 3 generated by $3g$, where $g = [\frac{a_1 - a_2}{9}] \in \text{discr } \mathbb{A}_2(3) \subset \text{discr } M$ is an order 9 element, expressed in terms of the standard generators a_1, a_2 of $\mathbb{A}_2(3)$, for which $a_i^2 = -6$, $a_1 a_2 = 3$. This extension leads to $L' = \mathbb{U}(3) + \mathbb{A}_2 + k\mathbb{E}_8(3)$ and $L = \mathbb{U}(6) + \mathbb{A}_2(2) + k\mathbb{E}_8(6)$. In the case $M = \mathbb{U}(3) + \mathbb{E}_6(3) + k\mathbb{E}_8(3)$, the corresponding isotropic group $H \subset \mathbb{E}_6(3) \subset \text{discr } M$ is generated by $3g$, for $g = [\frac{e_1 - e_2 + e_4 - e_5}{9}] \in \text{discr } \mathbb{E}_6(3)$, where $e_1, \dots, e_5 \in \mathbb{E}_6$ are the generators representing five consecutive vertices in the Dynkin \mathbb{E}_6 -graph. If we denote by N the extension of $\mathbb{E}_6(3)$ defined by H , then we obtain isomorphisms $L' = \mathbb{U}(3) + N + k\mathbb{E}_8(3)$, and $L = \mathbb{U}(6) + N(2) + \mathbb{E}_8(6)$.

Now, Proposition 7.5.1 follows, since our lattices L are distinguished by their ranks in the case $\delta_2(L) = 0$, and by ranks and $\text{discr}_3 L$ in the case $\delta_2(L) = 1$. \square

Remark. Row 14 of Table 6B refers to the case $\delta_2(L) = 0$, and rows 10,11,15,16, and 18 refer the case $\delta_2(L) = 1$ (for row 18, recall that $\mathbb{U}(6) + \mathbb{A}_1 = \langle 6 \rangle + \langle -6 \rangle + \mathbb{A}_1$).

7.6. The case of $r_3 = r - 1$, $r_2 < r$. Using the relation $\mathbb{U}(3) + \mathbb{A}_1 = \langle 6 \rangle + \mathbb{A}_2$, one can see that the lattices in Table 6B with $r_3 = r - 1$ and $r_2 < r$ all have a direct summand \mathbb{A}_2 or $\mathbb{A}_2(2)$, and thus, by Proposition 3.4.1, the complementary direct summand is divisible by 3, that is have form $L_1(3)$, where L_1 is an even lattice.

7.6.1. Proposition. *Assume that $L_0 = \mathbb{A}_2(n) + L_1(3)$ is an indefinite even lattice, $n \in \{1, 2\}$, where L_1 is a lattice of rank $r - 2 \geq 1$ whose discriminant is a 2-torsion group of rank $r_2 \leq r - 2$ if $n = 1$ and $r_2 \leq r - 3$ if $n = 2$. Then lattice L_0 is stable.*

Proof. Let L be an arbitrary lattice having the same inertia indices and discriminant as L_0 . Consider the sublattice $M = L_{(3)} = \{x \in L \mid xL \subset 3\mathbb{Z}\}$ of L , and let $M' = M(\frac{1}{3})$ (this resembles the construction of M and M' in Proposition 7.5.1, but now it is applied directly to L rather than to L'). By Proposition 3.4.1, the only discriminant factors of $\text{discr } M'$ are 2 and 3, these factors are elementary, $r_3(M') = 1$ and $r_2(M') = r_2(L_0)$.

If we apply the same construction to $L = L_0$, we obtain $M_0 = \mathbb{A}_2(3n) + L_1(3)$ and $M'_0 = \mathbb{A}_2(n) + L_1$ respectively. Our first step in the proof is to show that $M = M_0$ and $M' = M'_0$. Note that our rank restrictions and Nikulin's criterion imply that M' is stable, as well as M'_0 , so to prove that they are isomorphic it is sufficient to justify that $\text{discr } M'$ is isomorphic to $\text{discr } M'_0 = \text{discr } \mathbb{A}_2(n) + \text{discr } L_1$. Let us analyze separately their primary components discr_2 and discr_3 .

7.6.2. Lemma. $\text{discr}_2(M') = \text{discr}_2(M'_0) = \text{discr}_2 \mathbb{A}_2(n) + \text{discr}_2 L_1$.

Proof. It follows from Lemma 3.8.2 that $\text{discr}_2 M = \text{discr}_2 L$, since the index $[L : M] = 3$ is odd. By Proposition 3.4.1(3),

$$\mathfrak{q}_M |_{\text{discr}_2 M} = 3\mathfrak{q}_{M'} |_{\text{discr}_2 M'} = -\mathfrak{q}_{M'} |_{\text{discr}_2 M'},$$

where the second equality is because the quadratic refinement on the 2-primary component discr_2 is $(\mathbb{Z}/4)$ -valued. Thus, isomorphism $\text{discr}_2 L = \text{discr}_2 L_0$ implies isomorphism $\text{discr}_2 M' = \text{discr}_2 M'_0$. \square

7.6.3. Lemma. $\text{discr}_3 M' = \text{discr}_3 M'_0 = \text{discr}_3 \mathbb{A}_2(n)$.

Proof. As it was already observed, $r_3(M') = r_3(M'_0) = 1$, and the components discr_3 of M' and M'_0 are elementary, so, for the required isomorphism it is enough to justify that $\text{Br}_3(M') = \text{Br}_3(M'_0)$, see Lemma 3.7.2. Lattices L, M, M' as well as L_0, M_0, M'_0 have all the same Brown invariant $\text{Br} = \text{Br}_2 + \text{Br}_3 = 2 - r \pmod{8}$ by van der Blij's theorem. By our assumptions, $\text{Br}_2(L) = \text{Br}_2(L_0) = \text{Br}_2(\mathbb{A}_2(n)) + \text{Br}_2 L_1(3)$, and in the proof of Lemma 7.6.2 we have obtained an isomorphism $\text{discr}_2 M = \text{discr}_2 L$ together with the anti-isomorphism $\text{discr}_2 M = -\text{discr}_2 M'$. Thus,

$$\text{Br}_2(M') = -\text{Br}_2(M) = -\text{Br}_2(L) = -\text{Br}_2(L_0) = -\text{Br}_2(M_0) = \text{Br}_2(M'_0),$$

from where we can determine Br_3 for these lattices and see that $\text{Br}_3(M') = \text{Br}_3(M'_0) = 2 - r + \text{Br}_2(L_0) \pmod{8}$. \square

7.6.4. Corollary. *There are isomorphisms $M' = M'_0 = \mathbb{A}_2(n) + L_1$ and $M = M_0 = \mathbb{A}_2(3n) + L_1(3)$.* \square

The second step of the proof of Proposition 7.6.1 consists, like in the previous Subsection, in proving the uniqueness of an isotropic subgroup $H \subset \text{discr} M = \text{discr} \mathbb{A}_2(n) + \text{discr} L_1(3)$ that defines a 3-elementary extension of index 3.

The following Lemma describes $\text{discr} \mathbb{A}_2(3)$. We denote by u_1, u_2 a standard basis of \mathbb{A}_2 such that $u_1^2 = u_2^2 = -2$, $u_1 u_2 = 1$. For the corresponding basis of $\mathbb{A}_2(3)$, we have $u_1^2 = u_2^2 = -6$, $u_1 u_2 = 3$.

7.6.5. Lemma. *As a group, $\text{discr} \mathbb{A}_2(3)$ is isomorphic to $\mathbb{Z}/9 + \mathbb{Z}/3$ with the generators $[v], [w] \in \text{discr} \mathbb{A}_2(3)$, where $v = \frac{1}{9}(u_1 - u_2)$ and $w = \frac{1}{3}u_1$. The quadratic refinement in $\text{discr} \mathbb{A}_2(3)$ is given by $\begin{pmatrix} -\frac{2}{9} & -\frac{1}{3} \\ -\frac{1}{3} & -\frac{2}{3} \end{pmatrix}$ with respect to basis v, w .*

Proof. $v^2 = \frac{1}{81}(-6 - 6 - 6) = -\frac{2}{9}$, $w^2 = \frac{1}{9}(-6) = -\frac{2}{3}$, $vw = \frac{1}{27}(-6 - 3) = -\frac{1}{3}$. \square

7.6.6. Corollary. *For any n coprime with 3, $\text{discr}_3 \mathbb{A}_2(3n)$ as a group is isomorphic to $\mathbb{Z}/9 + \mathbb{Z}/3$, and the quadratic refinement in $\text{discr}_3 \mathbb{A}_2(3n)$ given by matrix $\begin{pmatrix} -\frac{2n}{9} & -\frac{n}{3} \\ -\frac{n}{3} & -\frac{2n}{3} \end{pmatrix}$.*

7.6.7. Lemma. *$\text{discr} M = \text{discr} \mathbb{A}_2(3n) + \text{discr} L_1(3)$ has a unique isotropy subgroup $H \subset \text{discr} M$ of order 3 such that H^\perp/H have no elements of order 9.*

Proof. Let $h \in \text{discr} M$ be a generator of H , then $h \in \text{discr}_3(M)$ one can split $h = a + b$, where $a \in \text{discr}_3 \mathbb{A}_2(3n)$, $b \in \text{discr}_3 L_1(3)$.

Decomposing $a = s[v] + t[w]$, we see that s is divisible by 3. This is because $h^2 = a^2 + b^2 = -n(2s^2/9 + st/3 + 2t^2/3) + b^2 = 0 \pmod{\mathbb{Z}}$, where $b^2 \in \frac{1}{3}\mathbb{Z}/\mathbb{Z}$, because $3b = 0$. This implies that $-2ns^2/3 = 0 \pmod{\mathbb{Z}}$, and so, $s \in 3\mathbb{Z}$.

Now, we consider two cases.

If $b = 0$, then $h^2 = a^2 = -2nt^2/3 \pmod{\mathbb{Z}}$, since $3|s$. Isotropy, $h^2 = 0$ implies that $t \in 3\mathbb{Z}$, and thus, $h = a = s[v]$ and $H = \{0, 3[v], 6[v]\}$. We will show that this isotropy group is the only one satisfying the conditions of the proposition. It is straightforward to check that the corresponding extension of $M = \mathbb{A}_2(3n) + L_1(3)$ of index 3 is the natural extension $\mathbb{A}_2(n) + L_1(3) \supset \mathbb{A}_2(3n) + L_1(3)$.

If $b \neq 0$, then we can find $x \in \text{discr}_3 L_1(3)$ such that $g = [v] + x$ lies in H^\perp . Namely, since $[v]a \in (\frac{1}{3}\mathbb{Z})/\mathbb{Z}$, we can use non-degeneracy of $\text{discr}_3(L_1(3))$ to find $x \in \text{discr}_3(L_1(3))$ such that $bx = -a[v]$, then $hg = a[v] + bx = 0$. Now, it is left to observe that the multiples kg , of g , $k \in \{1, \dots, 8\}$, do not belong to H . Because, $kg = k([v] + x) \in H = \{0, h, 2h\} = \{0, s[v] + t[w] + b, 2s[v] + 2t[w] + 2b\}$ implies that $k \in 3\mathbb{Z}$ (since $3|s$), thus $kg = k[v]$, which contradicts to $b \neq 0$. Thus, g has the same order in H^\perp/H as in $\text{discr}_3 M$, that is order 9. \square

Lemma 7.6.7 completes the proof of Proposition 7.6.1. \square

7.6.8. Theorem. *All the lattices in Tables 5A-J are stable.*

Proof. The lattices in Tables 5A-J for which Nikulin's stability criterion fails are analyzed in Subsections 7.4–7.6 and proved to be stable. Namely, the case of $r_3 = r$ is considered in Lemmas 7.4.2 and 7.4.3. The case of $r_3 = r - 1$ is the content of Subsections 7.5 and 7.6. In the case $r_3 \leq r - 2$ a lattice should be stable by Nikulin's criterion with the only possible exception $r_2 = r \leq 2$. Together with $r_3 \leq r - 2$ this implies $r_2 = r = 2$, $r_3 = 0$, which is again a case covered by Lemma 7.4.2. \square

7.6.9. Corollary. *Tables 5A-J give a complete list of T-halves.*

Proof. Proposition 7.1.2 gives a list of the invariants (r, r_2, δ_2, p, q) which can be potentially realized for T-halves. Proposition 7.2.1 shows that this list is actually realized by lattices in Tables 5A-J. Theorem 7.6.8 shows that there is no other T-halves with the same invariants, and so, Tables 5A-J give a complete list. \square

7.6.10. Corollary. *A T-half M is determined by its rank r , 2-rank r_2 , parity δ_2 of $\text{discr}_2 M$, and the characteristics $0 \leq p \leq 1$, $0 \leq q \leq 3$ of $\text{discr}_3 M = p\langle \frac{2}{3} \rangle + q\langle -\frac{2}{3} \rangle$. In particular, M is determined by r and $\text{discr} M$.*

7.7. The list of ascending T-pairs.

If we combine T-halves in Tables 5A-J into ascending T-pairs in accordance with the Table 4, then we obtain the following result.

7.7.1. Theorem. *Tables 7A-B give a complete list of the ascending T-pairs (T_+, T_-) .* \square

7.8. Property of $(-\frac{1}{2})$ -transitivity for the eigenlattices T_- . We say that lattice M is $(-\frac{1}{2})$ -transitive if the automorphism group $\text{Aut}(M)$ induces a transitive action on the non-characteristic elements $x \in \text{discr}_2(M) \subset \text{discr} M$ with $\mathfrak{q}_M(x) = -\frac{1}{2}$. Note that for the characteristic element, $v \in \text{discr}_2(M)$ the value $\mathfrak{q}_M(v)$ is determined by the Brown invariant of $\text{discr}_2 M$. For instance, if $\text{discr}_2 M = p\langle \frac{1}{2} \rangle + q\langle -\frac{1}{2} \rangle$, then $\mathfrak{q}_M(v) = \frac{p-q}{2} \pmod{2\mathbb{Z}}$, so, $\mathfrak{q}_M(v) = -\frac{1}{2}$ if and only if $\text{Br}_2(M) = 3 \pmod{4}$.

7.8.1. Proposition. *All the eigenlattices T_- in the Tables 5 and 6A-B are $(-\frac{1}{2})$ -transitive.*

Proof. First, note that the automorphisms of $\text{discr}_2 T_-$ act transitively on the non-characteristic $(-\frac{1}{2})$ -elements.

7.8.2. Lemma. *For any elementary enhanced 2-group G the isometry group $\text{Aut}(G)$ acts transitively on the non-characteristic elements $x \in G$ having $\mathfrak{q}(x) = -\frac{1}{2}$.*

Proof. If V contains $v \in G$ such that $\mathfrak{q}(v) = -\frac{1}{2}$, then q is odd and $G = p\langle \frac{1}{2} \rangle + q\langle -\frac{1}{2} \rangle$, where $p - q = \text{Br}(q)$. The orthogonal complement, G^v , of v is odd if and only if v is not characteristic,

Table 7A. Ascending T-pairs T_{\pm} in the case of $p = 0$

| | δ_2 | (r, r_2) | q | T_+ | T_- |
|----|------------|------------|-----|--|---|
| 1 | 0 | (2, 0) | 0 | \mathbb{U} | $\mathbb{U}(3) + 2\mathbb{A}_2 + \mathbb{A}_1$ |
| 2 | 0 | (4, 0) | 1 | $\mathbb{U} + \mathbb{A}_2$ | $\mathbb{U}(3) + \mathbb{A}_2 + \mathbb{A}_1$ |
| 3 | 0 | (6, 0) | 2 | $\mathbb{U} + 2\mathbb{A}_2$ | $\mathbb{U}(3) + \mathbb{A}_1$ |
| 4 | 0 | (8, 0) | 3 | $\mathbb{U} + 3\mathbb{A}_2$ | $\langle 6 \rangle$ |
| 5 | 1 | (1, 1) | 0 | $\langle 2 \rangle$ | $\mathbb{U}(3) + 2\mathbb{A}_2 + 2\mathbb{A}_1$ |
| 6 | 1 | (3, 1) | 0 | $\mathbb{U} + \mathbb{A}_1$ | $\langle 6 \rangle + \langle -6 \rangle + 2\mathbb{A}_2$ |
| 7 | 1 | (3, 1) | 1 | $\mathbb{U} + \langle -6 \rangle$ | $\mathbb{U}(3) + \mathbb{A}_2 + 2\mathbb{A}_1$ |
| 8 | 1 | (5, 1) | 1 | $\mathbb{U} + \mathbb{A}_2 + \mathbb{A}_1$ | $\langle 6 \rangle + \langle -6 \rangle + \mathbb{A}_2$ |
| 9 | 1 | (5, 1) | 2 | $\langle 2 \rangle + 2\mathbb{A}_2$ | $\mathbb{U}(3) + 2\mathbb{A}_1$ |
| 10 | 1 | (7, 1) | 2 | $\mathbb{U} + 2\mathbb{A}_2 + \mathbb{A}_1$ | $\langle 6 \rangle + \langle -6 \rangle$ |
| 11 | 1 | (7, 1) | 3 | $\langle 2 \rangle + 3\mathbb{A}_2$ | $\langle 6 \rangle + \mathbb{A}_1$ |
| 12 | 0 | (2, 2) | 0 | $\mathbb{U}(2)$ | $\langle 6 \rangle + \langle -6 \rangle + 2\mathbb{A}_2 + \mathbb{A}_1$ |
| 13 | 1 | (2, 2) | 0 | $\langle 2 \rangle + \mathbb{A}_1$ | $\langle 6 \rangle + \langle -6 \rangle + 2\mathbb{A}_2 + \mathbb{A}_1$ |
| 14 | 1 | (2, 2) | 1 | $\langle 2 \rangle + \langle -6 \rangle$ | $\langle 6 \rangle + 2\mathbb{A}_2 + 2\mathbb{A}_1$ |
| 15 | 0 | (4, 2) | 3 | $\mathbb{U}(3) + \mathbb{A}_2(2)$ | $\mathbb{U} + \mathbb{A}_2(2) + \mathbb{A}_1$ |
| 16 | 1 | (4, 2) | 0 | $\mathbb{U} + 2\mathbb{A}_1$ | $\langle 6 \rangle + 2\langle -6 \rangle + \mathbb{A}_2$ |
| 17 | 1 | (4, 2) | 1 | $\langle 2 \rangle + \mathbb{A}_2 + \mathbb{A}_1$ | $\langle 6 \rangle + \langle -6 \rangle + \mathbb{A}_2 + \mathbb{A}_1$ |
| 18 | 1 | (4, 2) | 2 | $\mathbb{U} + 2\langle -6 \rangle$ | $\mathbb{U}(3) + 3\mathbb{A}_1$ |
| 19 | 0 | (4, 2) | 1 | $\mathbb{U}(2) + \mathbb{A}_2$ | $\langle 6 \rangle + \langle -6 \rangle + \mathbb{A}_2 + \mathbb{A}_1$ |
| 20 | 0 | (6, 2) | 2 | $\mathbb{U}(2) + 2\mathbb{A}_2$ | $\langle 6 \rangle + \langle -6 \rangle + \mathbb{A}_1$ |
| 21 | 1 | (6, 2) | 2 | $\mathbb{U} + \mathbb{A}_2 + \langle -6 \rangle + \mathbb{A}_1$ | $\langle 6 \rangle + \langle -6 \rangle + \mathbb{A}_1$ |
| 22 | 1 | (6, 2) | 3 | $\langle 2 \rangle + 2\mathbb{A}_2 + \langle -6 \rangle$ | $\langle 6 \rangle + 2\mathbb{A}_1$ |
| 23 | 1 | (6, 2) | 1 | $\mathbb{U} + \mathbb{A}_2 + 2\mathbb{A}_1$ | $\langle 6 \rangle + 2\langle -6 \rangle$ |
| 24 | 1 | (3, 3) | 0 | $\langle 2 \rangle + 2\mathbb{A}_1$ | $\langle 6 \rangle + 2\langle -6 \rangle + \mathbb{A}_2 + \mathbb{A}_1$ |
| 25 | 1 | (3, 3) | 1 | $\langle 2 \rangle + \mathbb{A}_1 + \langle -6 \rangle$ | $\langle 6 \rangle + \langle -6 \rangle + \mathbb{A}_2 + 2\mathbb{A}_1$ |
| 26 | 1 | (3, 3) | 2 | $\langle 2 \rangle + 2\langle -6 \rangle$ | $\mathbb{U}(3) + 4\mathbb{A}_1$ |
| 27 | 1 | (5, 3) | 3 | $\mathbb{U} + 3\langle -6 \rangle$ | $\langle 6 \rangle + 3\mathbb{A}_1$ |
| 28 | 1 | (5, 3) | 2 | $\langle 2 \rangle + \mathbb{A}_2 + \mathbb{A}_1 + \langle -6 \rangle$ | $\langle 6 \rangle + \langle -6 \rangle + 2\mathbb{A}_1$ |
| 29 | 1 | (5, 3) | 1 | $\langle 2 \rangle + \mathbb{A}_2 + 2\mathbb{A}_1$ | $\langle 6 \rangle + 2\langle -6 \rangle + \mathbb{A}_1$ |
| 30 | 1 | (5, 3) | 0 | $\mathbb{U} + 3\mathbb{A}_1$ | $\langle 6 \rangle + 3\langle -6 \rangle$ |
| 31 | 1 | (4, 4) | 0 | $\langle 2 \rangle + 3\mathbb{A}_1$ | $\langle 6 \rangle + 3\langle -6 \rangle + \mathbb{A}_1$ |
| 32 | 1 | (4, 4) | 1 | $\langle 2 \rangle + 2\mathbb{A}_1 + \langle -6 \rangle$ | $\langle 6 \rangle + 2\langle -6 \rangle + \mathbb{A}_1$ |
| 33 | 1 | (4, 4) | 2 | $\langle 2 \rangle + \mathbb{A}_1 + 2\langle -6 \rangle$ | $\langle 6 \rangle + \langle -6 \rangle + 3\mathbb{A}_1$ |
| 34 | 1 | (4, 4) | 3 | $\langle 2 \rangle + 3\langle -6 \rangle$ | $\langle 6 \rangle + 4\mathbb{A}_1$ |
| 35 | 0 | (4, 4) | 3 | $\mathbb{U}(6) + \mathbb{A}_2(2)$ | $\langle 6 \rangle + 4\mathbb{A}_1$ |

and in the latter case, $G^v = \langle \frac{1}{2} \rangle + (q-1)\langle -\frac{1}{2} \rangle$. Thus, for any other non-characteristic element $w \in G$ with $\mathfrak{q}(w) = -\frac{1}{2}$, we obtain an isomorphism $G^v \rightarrow G^w$ which is extended to G so that v is sent to w . \square

It follows that 2-epistability implies $(-\frac{1}{2})$ -transitivity. So, we should analyze only the lattices T_- , for which Nikulin's stability criterion fails. Among these cases there are trivial ones, with $\text{discr}_2 T_-$ containing only one or no non-characteristic $(-\frac{1}{2})$ -elements. This happens if $r_2(T_-) \leq 1$, or if $\text{discr}_2(T_-)$ is isomorphic to $2\langle \frac{1}{2} \rangle$, $\langle \frac{1}{2} \rangle + \langle -\frac{1}{2} \rangle$, $3\langle \frac{1}{2} \rangle$, or $2\langle \frac{1}{2} \rangle + \langle -\frac{1}{2} \rangle$.

So, it is left to consider only those lattices T_- non satisfying Nikulin's criterion, for which $\text{discr}_2(T_-)$ is $2\langle -\frac{1}{2} \rangle$, $\langle \frac{1}{2} \rangle + 2\langle -\frac{1}{2} \rangle$, $3\langle -\frac{1}{2} \rangle$, or $r_2(T_-) \geq 4$. Analyzing the lattices T_- in Tables 5 and 6A-B, in Section 7.2, we find that there remain only the following cases to consider

Table 7B. Ascending T-pairs T_{\pm} in the case of $p = 1$

| | δ_2 | (r_+, r_2) | q | T_+ | T_- |
|----|------------|--------------|-----|--|---|
| 1 | 0 | (2, 0) | 1 | $\mathbb{U}(3)$ | $\mathbb{U} + 3\mathbb{A}_2$ |
| 2 | 0 | (4, 0) | 2 | $\mathbb{U}(3) + \mathbb{A}_2$ | $\mathbb{U} + \mathbb{A}_2 + \mathbb{A}_1$ |
| 3 | 0 | (6, 0) | 3 | $\mathbb{U}(3) + 2\mathbb{A}_2$ | $\mathbb{U} + \mathbb{A}_1$ |
| 4 | 1 | (1, 1) | 0 | $\langle 6 \rangle$ | $\mathbb{U} + 2\mathbb{A}_2 + \mathbb{A}_1 + \langle -6 \rangle$ |
| 5 | 1 | (3, 1) | 1 | $\langle 6 \rangle + \mathbb{A}_2$ | $\langle 2 \rangle + 2\mathbb{A}_2 + \mathbb{A}_1$ |
| 6 | 1 | (3, 1) | 2 | $\mathbb{U}(3) + \langle -6 \rangle$ | $\mathbb{U} + \mathbb{A}_2 + 2\mathbb{A}_1$ |
| 7 | 1 | (5, 1) | 2 | $\mathbb{U}(3) + \mathbb{A}_2 + \mathbb{A}_1$ | $\mathbb{U} + \langle -6 \rangle + \mathbb{A}_1$ |
| 8 | 1 | (5, 1) | 3 | $\mathbb{U}(3) + \mathbb{A}_2 + \langle -6 \rangle$ | $\mathbb{U} + 2\mathbb{A}_1$ |
| 9 | 1 | (7, 1) | 3 | $\langle 6 \rangle + 3\mathbb{A}_2$ | $\langle 2 \rangle + \mathbb{A}_1$ |
| 10 | 0 | (2, 2) | 1 | $\mathbb{U}(6)$ | $\mathbb{U}(2) + 2\mathbb{A}_2 + \mathbb{A}_1$ |
| 11 | 1 | (2, 2) | 1 | $\langle 6 \rangle + \langle -6 \rangle$ | $\mathbb{U} + \mathbb{A}_2 + 2\mathbb{A}_1 + \langle -6 \rangle$ |
| 12 | 1 | (2, 2) | 0 | $\langle 6 \rangle + \mathbb{A}_1$ | $\langle 2 \rangle + 2\mathbb{A}_2 + \mathbb{A}_1 + \langle -6 \rangle$ |
| 13 | 0 | (4, 2) | 0 | $\mathbb{U} + \mathbb{A}_2(2)$ | $\mathbb{U}(3) + \mathbb{A}_2(2) + \mathbb{A}_1$ |
| 14 | 0 | (4, 2) | 2 | $\mathbb{U}(6) + \mathbb{A}_2$ | $\mathbb{U}(2) + \mathbb{A}_2 + \mathbb{A}_1$ |
| 15 | 1 | (4, 2) | 2 | $\langle 6 \rangle + \mathbb{A}_2 + \langle -6 \rangle$ | $\langle 2 \rangle + \mathbb{A}_2 + 2\mathbb{A}_1$ |
| 16 | 1 | (4, 2) | 1 | $\langle 6 \rangle + \mathbb{A}_2 + \mathbb{A}_1$ | $\langle 2 \rangle + \langle -6 \rangle + \mathbb{A}_2 + \mathbb{A}_1$ |
| 17 | 1 | (4, 4) | 3 | $\langle 6 \rangle + 3\langle -6 \rangle$ | $\langle 2 \rangle + 4\mathbb{A}_1$ |
| 18 | 1 | (4, 2) | 3 | $\mathbb{U}(3) + 2\langle -6 \rangle$ | $\mathbb{U} + 3\mathbb{A}_1$ |
| 19 | 0 | (6, 2) | 3 | $\mathbb{U}(6) + 2\mathbb{A}_2$ | $\mathbb{U}(2) + \mathbb{A}_1$ |
| 20 | 0 | (6, 2) | 1 | $\mathbb{U}(3) + \mathbb{D}_4$ | $\langle 6 \rangle + \mathbb{A}_2(2)$ |
| 21 | 1 | (6, 2) | 2 | $\langle 6 \rangle + 2\mathbb{A}_2 + \mathbb{A}_1$ | $\langle 2 \rangle + \mathbb{A}_1 + \langle -6 \rangle$ |
| 22 | 1 | (6, 2) | 3 | $\mathbb{U}(3) + \mathbb{A}_2 + \mathbb{A}_1 + \langle -6 \rangle$ | $\langle 2 \rangle + 2\mathbb{A}_1$ |
| 23 | 1 | (3, 3) | 0 | $\langle 6 \rangle + 2\mathbb{A}_1$ | $\langle 2 \rangle + 2\langle -6 \rangle + \mathbb{A}_2 + \mathbb{A}_1$ |
| 24 | 1 | (3, 3) | 1 | $\langle 6 \rangle + \mathbb{A}_1 + \langle -6 \rangle$ | $\langle 2 \rangle + \mathbb{A}_2 + 2\mathbb{A}_1 + \langle -6 \rangle$ |
| 25 | 1 | (3, 3) | 2 | $\langle 6 \rangle + 2\langle -6 \rangle$ | $\mathbb{U} + \langle -6 \rangle + 3\mathbb{A}_1$ |
| 26 | 1 | (5, 3) | 0 | $\langle 6 \rangle + \mathbb{D}_4$ | $\langle 6 \rangle + \mathbb{A}_2(2) + \langle -6 \rangle$ |
| 27 | 1 | (5, 3) | 1 | $\langle 6 \rangle + \mathbb{A}_2 + 2\mathbb{A}_1$ | $\langle 2 \rangle + \mathbb{A}_1 + 2\langle -6 \rangle$ |
| 28 | 1 | (5, 3) | 3 | $\langle 6 \rangle + \mathbb{A}_2 + 2\langle -6 \rangle$ | $\langle 2 \rangle + 3\mathbb{A}_1$ |
| 29 | 1 | (5, 3) | 2 | $\langle 6 \rangle + \mathbb{A}_2 + \mathbb{A}_1 + \langle -6 \rangle$ | $\langle 2 \rangle + 2\mathbb{A}_1 + \langle -6 \rangle$ |
| 30 | 1 | (4, 4) | 0 | $\langle 6 \rangle + 3\mathbb{A}_1$ | $\langle 2 \rangle + \mathbb{A}_1 + 3\langle -6 \rangle$ |
| 31 | 1 | (4, 4) | 1 | $\langle 6 \rangle + \langle -6 \rangle + 2\mathbb{A}_1$ | $\langle 2 \rangle + 2\mathbb{A}_1 + 2\langle -6 \rangle$ |
| 32 | 1 | (4, 4) | 2 | $\langle 6 \rangle + \mathbb{A}_1 + 2\langle -6 \rangle$ | $\langle 2 \rangle + 3\mathbb{A}_1 + \langle -6 \rangle$ |

- (1) $\langle 6 \rangle + 3\langle -6 \rangle$,
- (2) $\langle 2 \rangle + 3\langle -6 \rangle$,
- (3) $\langle 6 \rangle + k\langle -6 \rangle + \mathbb{A}_1$, $0 \leq k \leq 3$.

If $T_- = \langle 6 \rangle + 3\langle -6 \rangle$, then $\text{discr}_2 T_- = \langle -\frac{1}{2} \rangle + 3\langle \frac{1}{2} \rangle$ contains two $(-\frac{1}{2})$ -elements, $\alpha_1 = (1, 0, 0, 0)$ and $\alpha_2 = (0, 1, 1, 1)$. The reflection ρ_v in T_- with respect to $v = (1, 1, 1, 1)$ permutes the lattice elements $a_1 = (1, 0, 0, 0)$ and $a_2 = (2, 1, 1, 1)$, thus, inducing an automorphism of $\text{discr}_2 T_-$ which permutes $\alpha_i = [\frac{a_i}{2}]$, $i = 1, 2$.

If $T_- = \langle 2 \rangle + 3\langle -6 \rangle$, then $\text{discr}_2 T_- = 4\langle \frac{1}{2} \rangle$ contains four $(-\frac{1}{2})$ -elements, $\alpha_1 = (0, 1, 1, 1)$, $\alpha_2 = (1, 0, 1, 1)$, $\alpha_3 = (1, 1, 0, 1)$, and $\alpha_4 = (1, 1, 1, 0)$. Automorphisms of T_- permuting the three $\langle -6 \rangle$ -components induce the corresponding permutations of α_2 , α_3 , and α_4 . The reflection ρ_v across $v = (1, 1, 0, 0)$ in T_- permutes α_1 and α_2 .

If $T_- = \langle 6 \rangle + \mathbb{A}_1$, then $\text{discr}_2 T_- = 2\langle -\frac{1}{2} \rangle$ has only one non-identity automorphism, which interchanges the coordinates. This automorphism is induced by the reflection ρ_v in T_- with respect to $v = (1, 1) \in T_-$. Thus, T_- is 2-epistable and in particular $(-\frac{1}{2})$ -transitive.

If $T_- = \langle 6 \rangle + \mathbb{A}_1 + \langle -6 \rangle$, then $\text{discr}_2 T_- = 2\langle -1/2 \rangle + \langle 1/2 \rangle$ contains exactly three $(-\frac{1}{2})$ -elements, one of which is characteristic, and the other two are permuted by the reflection ρ_v in T_- with respect to $v = (1, 1, 0)$ (similar to the previous case).

If $T_- = \langle 6 \rangle + \mathbb{A}_1 + 2\langle -6 \rangle$, then $\text{discr}_2 T_- = 2\langle -\frac{1}{2} \rangle + 2\langle \frac{1}{2} \rangle$ contains four $(-\frac{1}{2})$ -elements, $\alpha_1 = (1, 0, 0, 0)$, $\alpha_2 = (0, 1, 0, 0)$, $\alpha_3 = (1, 1, 1, 0)$, and $\alpha_4 = (1, 1, 0, 1)$. They admit lifting to (-2) -vectors $a_1 = (1, 2, 0, 0)$, $a_2 = (0, 1, 0, 0)$, $a_3 = (1, 1, 1, 0)$, and $a_4 = (1, 1, 0, 1)$ in T_- , so that $\alpha_i = [\frac{a_i}{2}]$, $1 \leq i \leq 4$. Like in the previous case, we can permute α_1 and α_2 by the reflection ρ_v across $v = (1, 1, 0, 0)$. Permutation of the $\langle -6 \rangle$ -components of T_- induces a permutation of α_3 and α_4 . Finally, note that the orthogonal complement, a_3^\perp , in T_- is $\mathbb{U}(6) + \langle -6 \rangle$, which is isomorphic to the orthogonal complement $a_2^\perp = \langle 6 \rangle + 2\langle -6 \rangle$. Such an isomorphism can be extended to T_- so that $a_3 \mapsto a_2$, which induces a discriminant automorphism sending α_3 to α_2 .

Finally, if $T_- = \langle 6 \rangle + \mathbb{A}_1 + 3\langle -6 \rangle$, then $-\frac{1}{2}$ -vectors in $\text{discr}_2 T_- = 2\langle -\frac{1}{2} \rangle + 3\langle \frac{1}{2} \rangle$ are the four elements $\alpha_1 = (1, 0, 0, 0, 0)$, $\alpha_2 = (0, 1, 0, 0, 0)$, $\alpha_3 = (1, 1, 1, 0, 0)$, $\alpha_4 = (1, 1, 0, 1, 0)$, which lie in the sublattice $2\langle -\frac{1}{2} \rangle + 2\langle \frac{1}{2} \rangle \subset \text{discr}_2 T_-$ considered above, and two other elements, $\alpha_5 = (1, 1, 0, 0, 1)$ and $\alpha_6 = (0, 0, 1, 1, 1)$. The first four elements can be permuted by automorphisms of the sublattice, $\langle 6 \rangle + \mathbb{A}_1 + 2\langle -6 \rangle \subset T_-$ (which are trivially extended to the whole T_-) as was described in the previous case. The element α_5 can be permuted with α_3 , and α_4 by automorphisms of T_- interchanging the components $\langle -6 \rangle$. Finally, α_6 and α_1 are transposed by the reflection ρ_v in T_- with respect to $v = (1, 0, 1, 1, 1) \in T_-$. This is because ρ_v interchanges 6-elements $a_1 = (1, 0, 0, 0, 0)$ and $a_6 = (2, 0, 1, 1, 1)$ in T_- , and $\alpha_i = [\frac{a_i}{2}]$, $i = 1, 6$. \square

8. BACK TO ZARISKI CURVES

8.1. Classification of geometric involutions.

8.1.1. Theorem. *Geometric involutions $c, c' \in C(L, \Delta, h)$ have the same homological type (i.e., $[c] = [c'] \in C[L, \Delta, h]$) if and only if the corresponding T-pairs $(T_+(c), T_-(c))$ and $(T_+(c'), T_-(c'))$ are isomorphic (i.e., $T_\pm(c) \cong T_\pm(c')$).*

Proof. The “only if” part is trivial. Assume that there are isomorphisms $T_\pm(c) \cong T_\pm(c')$. Without loss of generality we may assume that $r_2(T_+) < r_2(T_-)$, i.e., that the involutions c and c' are ascending. Using Proposition 3.13.2 we can observe that the restrictions $c|_T$ and $c'|_T$ to the sublattice $T \subset L$ are conjugate via some automorphism $f_T: T \rightarrow T$. Note that the assumptions of 3.13.2 are satisfied due to Corollary 7.3.2, Lemma 4.9.6, and Proposition 7.8.1. Namely, Lemma 4.9.6 implies that transitivity of the action of $\text{Aut}(T_-)$ on the subgroups of $\text{discr}_2(T_-)$ anti-isomorphic to $\text{discr}_2(T_+)$ is equivalent to the correspondent transitivity of this group action on the elements of $\text{discr}_2 T_-$ whose square is $-\frac{1}{2}$, and Proposition 7.8.1 establishes this transitivity.

Next, we extend f_T to an automorphism $f_{T'}: T' \rightarrow T'$, letting $h \mapsto h$ (see Section 3.10). Since $c(h) = c'(h) = -h$, the restrictions $c|_{T'}$ and $c'|_{T'}$ are conjugate via $f_{T'}$.

Finally, using Proposition 5.4.5 and Corollary 5.3.4 we conclude that $f_{T'}$ can be extended to $f \in \text{Aut}(L, \Delta, h)$ that conjugates c with c' . \square

8.2. Reversion roots. Given an ascending T-pair (T_1, T_2) , we say that an element $v \in T_2$ is a *reversion root* for (T_1, T_2) if, first, it is an even (-2) -element (see the definitions in Section 3.10), and, second, $[\frac{v}{2}] \in \text{discr}_2 T_2$ is a characteristic element in the case $\delta_2(T_1) = 0$, and non-characteristic in the case $\delta_2(T_1) = 1$. Due to Lemma 3.10.2) the latter condition implies the following property of the orthogonal complement $T_2^v \subset T_2$ of v .

8.2.1. Corollary. $\delta_2(T_1) = \delta_2(T_2^v)$. \square

8.3. Reversion partners of T-pairs. Given an ascending T-pair (T_1, T_2) and a reversion root $v \in T_2$, we can write $T_2 = \mathbb{Z}v + T_2^v$. Interchanging T_1 and T_2^v we obtain another pair $(T_2^v, \mathbb{Z}v + T_1)$, which will be called *the reversion partner of (T_1, T_2) with respect to v* . If a reversion root does exist, we say that (T_1, T_2) is a *reversible pair*.

8.3.1. Lemma. *The reversion partner $(T'_1, T'_2) = (T_2^v, T_v)$ is also an ascending T-pair. Moreover,*

- (1) $r(T'_i) = 8 - r(T_i)$, $i = 1, 2$;
- (2) $r_2(T'_i) = r_2(T_i)$, and $\delta_2(T'_i) = \delta_2(T_i)$;
- (3) $\text{discr}_3(T'_1) = \text{discr}_3(T_2)$, $\text{discr}_3(T'_2) = \text{discr}_3(T_1)$, and, in particular, if $\text{discr}_3(T_i) = p\langle\frac{2}{3}\rangle + q\langle-\frac{2}{3}\rangle$ then $\text{discr}_3(T'_i) = (1 - p)\langle\frac{2}{3}\rangle + (3 - q)\langle-\frac{2}{3}\rangle$.

Furthermore, $v \in T_2'$ is a reversion root of (T'_1, T'_2) and the reversion partner of (T'_1, T'_2) with respect to v is (T_1, T_2) .

Proof. From the construction of (T'_1, T'_2) it follows that $r(T'_1) = r(T_2) - 1 = (9 - r(T_1)) - 1$, and $r(T'_2) - 1 = r(T_1) = 9 - r(T_2)$, which gives (1). Next, $r_2(T'_1) = r_2(T_2) - 1 = r_2(T_1)$, and Corollary 8.2.1 yields (2). Lemma 3.10.1 implies that $\text{discr}_3(v^\perp) = \text{discr}_3(T_1)$, which implies (3). The last claim is obvious from the construction. \square

8.3.2. Proposition. *For any ascending pair (T_1, T_2) , its reversion partner (T'_1, T'_2) if exists is independent up to isomorphism of the choice of a reversion root v .*

Proof. By Lemma 8.3.1 the invariants r , r_2 , δ_2 , p , and q of T'_i are determined by those of T_i . These invariants determine an ascending T-pair uniquely up to isomorphism, see Corollary 7.6.10. \square

8.3.3. Theorem. *A reversion partner exists for all the ascending T-pairs except six pairs (T_1, T_2) listed in Table 8A. The partnership of the remaining 62 ascending T-pairs is shown in Tables 8B-C, where partners are placed in the same rows.*

Table 8A. Irreversible T-pairs

| | δ_2 | (r, r_2) | (p, q) | (r', r'_2) | (p', q') | T_1 | T_2 |
|---|------------|------------|----------|--------------|------------|---|---|
| 1 | 0 | (8, 0) | (0, 3) | (1, 1) | (1, 0) | $\mathbb{U} + 3\mathbb{A}_2$ | $\langle 6 \rangle$ |
| 2 | 1 | (7, 1) | (0, 2) | (2, 2) | (1, 1) | $\mathbb{U} + 2\mathbb{A}_2 + \mathbb{A}_1$ | $\langle 6 \rangle + \langle -6 \rangle$ |
| 3 | 0 | (6, 2) | (1, 1) | (3, 3) | (0, 2) | $\mathbb{U}(3) + \mathbb{D}_4$ | $\langle 6 \rangle + \mathbb{A}_2(2)$ |
| 4 | 1 | (6, 2) | (0, 1) | (3, 3) | (1, 2) | $\mathbb{U} + \mathbb{A}_2 + 2\mathbb{A}_1$ | $\langle 6 \rangle + 2\langle -6 \rangle$ |
| 5 | 1 | (5, 3) | (0, 0) | (4, 4) | (1, 3) | $\mathbb{U} + 3\mathbb{A}_1$ | $\langle 6 \rangle + 3\langle -6 \rangle$ |
| 6 | 1 | (5, 3) | (1, 0) | (4, 4) | (0, 3) | $\langle 6 \rangle + \mathbb{D}_4$ | $\langle 2 \rangle + 3\langle -6 \rangle$ |

Proof. For the reversion partners the invariants r , r_2 , δ , p , and q should match as is indicated in Lemma 8.3.1. For the six exceptional T-pairs in Table 8A there is no candidates to be a partner with the matching invariants. For the other T-pairs such a candidate is unique, since these invariants uniquely determine an ascending T-pair by Corollary 7.6.10. It is straightforward to check that the T-pairs placed in the same rows in Tables 8B-C have matching above invariants. Now, it is sufficient to check existence of a reversion root $v \in T_2$ for every T-pair (T_1, T_2) in Table 8B (this implies existence of a reversion root in the partner T-pair in Table 8C). This is also straightforward and easy. \square

8.3.4. Proposition. *If ascending T-pairs $(T_+(c), T_-(c))$ and $(T_+(c'), T_-(c'))$ associated with Zariski curves, A and A' , are reversion partners, then A and A' are reversion partners themselves.*

Proof. Lemma 4.9.6, which reduces the transitivity of the action of $\text{Aut}(T_-)$ on the subgroups of $\text{discr}_2(T_-)$ anti-isomorphic to $\text{discr}_2(T_+)$ to the transitivity on the elements of $\text{discr}_2 T_-$ whose square is $-\frac{1}{2}$, and Proposition 7.8.1, which establishes the latter transitivity, imply that h is glued with a reversion root v . Thus, h and v generate an \mathbb{U} -summand in T'_- . Therefore, $c' = c^\vee$ in the sense of Section 6.4. Applying Proposition 6.4.1 we find an example of reversion partners, B and B' , that have the same homological types as A and A' , respectively. By Theorem 8.1.1 and Theorem 6.3.1, B is deformation equivalent to A and B' to A' . \square

Table 8B. The case of $o = -$ ($p = 0$)Table 8C. The case of $o = +$ ($p = 1$)

| | (r, r_2) | q | δ_2 | T_1 | T_2 | (r, r_2) | T_1 | T_2 |
|----|------------|-----|------------|--|---|------------|--|---|
| 1 | (2, 0) | 0 | 0 | \mathbb{U} | $\mathbb{U}(3) + 2\mathbb{A}_2 + \mathbb{A}_1$ | (6, 0) | $\mathbb{U}(3) + 2\mathbb{A}_2$ | $\mathbb{U} + \mathbb{A}_1$ |
| 2 | (4, 0) | 1 | 0 | $\mathbb{U} + \mathbb{A}_2$ | $\mathbb{U}(3) + \mathbb{A}_2 + \mathbb{A}_1$ | (4, 0) | $\mathbb{U}(3) + \mathbb{A}_2$ | $\mathbb{U} + \mathbb{A}_2 + \mathbb{A}_1$ |
| 3 | (6, 0) | 2 | 0 | $\mathbb{U} + 2\mathbb{A}_2$ | $\mathbb{U}(3) + \mathbb{A}_1$ | (2, 0) | $\mathbb{U}(3)$ | $\mathbb{U} + 3\mathbb{A}_2$ |
| 4 | (1, 1) | 0 | 1 | $\langle 2 \rangle$ | $\mathbb{U}(3) + 2\mathbb{A}_2 + 2\mathbb{A}_1$ | (7, 1) | $\langle 6 \rangle + 3\mathbb{A}_2$ | $\langle 2 \rangle + \mathbb{A}_1$ |
| 5 | (3, 1) | 0 | 1 | $\mathbb{U} + \mathbb{A}_1$ | $\langle 6 \rangle + \langle -6 \rangle + 2\mathbb{A}_2$ | (5, 1) | $\mathbb{U}(3) + \mathbb{A}_2 + \langle -6 \rangle$ | $\mathbb{U} + 2\mathbb{A}_1$ |
| 6 | (3, 1) | 1 | 1 | $\mathbb{U} + \langle -6 \rangle$ | $\mathbb{U}(3) + \mathbb{A}_2 + 2\mathbb{A}_1$ | (5, 1) | $\mathbb{U}(3) + \mathbb{A}_2 + \mathbb{A}_1$ | $\mathbb{U} + \langle -6 \rangle + \mathbb{A}_1$ |
| 7 | (5, 1) | 1 | 1 | $\mathbb{U} + \mathbb{A}_2 + \mathbb{A}_1$ | $\langle 6 \rangle + \langle -6 \rangle + \mathbb{A}_2$ | (3, 1) | $\mathbb{U}(3) + \langle -6 \rangle$ | $\mathbb{U} + \mathbb{A}_2 + 2\mathbb{A}_1$ |
| 8 | (5, 1) | 2 | 1 | $\langle 2 \rangle + 2\mathbb{A}_2$ | $\mathbb{U}(3) + 2\mathbb{A}_1$ | (3, 1) | $\langle 6 \rangle + \mathbb{A}_2$ | $\langle 2 \rangle + 2\mathbb{A}_2 + \mathbb{A}_1$ |
| 9 | (7, 1) | 3 | 1 | $\langle 2 \rangle + 3\mathbb{A}_2$ | $\langle 6 \rangle + \mathbb{A}_1$ | (1, 1) | $\langle 6 \rangle$ | $\mathbb{U} + 2\mathbb{A}_2 + \mathbb{A}_1 + \langle -6 \rangle$ |
| 10 | (2, 2) | 0 | 0 | $\mathbb{U}(2)$ | $\langle 6 \rangle + 2\mathbb{A}_2 + \langle -6 \rangle + \mathbb{A}_1$ | (6, 2) | $\mathbb{U}(6) + 2\mathbb{A}_2$ | $\langle 2 \rangle + 2\mathbb{A}_1$ |
| 11 | (2, 2) | 0 | 1 | $\langle 2 \rangle + \mathbb{A}_1$ | $\langle 6 \rangle + 2\mathbb{A}_2 + \langle -6 \rangle + \mathbb{A}_1$ | (6, 2) | $\mathbb{U}(3) + \mathbb{A}_2 + \mathbb{A}_1 + \langle -6 \rangle$ | $\langle 2 \rangle + 2\mathbb{A}_1$ |
| 12 | (2, 2) | 1 | 1 | $\langle 2 \rangle + \langle -6 \rangle$ | $\langle 6 \rangle + 2\mathbb{A}_2 + 2\mathbb{A}_1$ | (6, 2) | $\langle 6 \rangle + 2\mathbb{A}_2 + \mathbb{A}_1$ | $\langle 2 \rangle + \mathbb{A}_1 + \langle -6 \rangle$ |
| 13 | (4, 2) | 2 | 1 | $\mathbb{U} + 2\mathbb{A}_1$ | $\langle 6 \rangle + 2\langle -6 \rangle + \mathbb{A}_2$ | (4, 2) | $\mathbb{U}(3) + 2\langle -6 \rangle$ | $\mathbb{U} + 3\mathbb{A}_1$ |
| 14 | (4, 2) | 1 | 0 | $\mathbb{U}(2) + \mathbb{A}_2$ | $\langle 6 \rangle + \langle -6 \rangle + \mathbb{A}_2 + \mathbb{A}_1$ | (4, 2) | $\mathbb{U}(6) + \mathbb{A}_2$ | $\langle 2 \rangle + \mathbb{A}_2 + 2\mathbb{A}_1$ |
| 15 | (4, 2) | 1 | 1 | $\langle 2 \rangle + \mathbb{A}_2 + \mathbb{A}_1$ | $\langle 6 \rangle + \langle -6 \rangle + \mathbb{A}_2 + \mathbb{A}_1$ | (4, 2) | $\langle 6 \rangle + \mathbb{A}_2 + \langle -6 \rangle$ | $\langle 2 \rangle + \mathbb{A}_2 + 2\mathbb{A}_1$ |
| 16 | (4, 2) | 2 | 1 | $\mathbb{U} + 2\langle -6 \rangle$ | $\mathbb{U}(3) + 3\mathbb{A}_1$ | (4, 2) | $\langle 6 \rangle + \mathbb{A}_2 + \mathbb{A}_1$ | $\langle 2 \rangle + \langle -6 \rangle + \mathbb{A}_2 + \mathbb{A}_1$ |
| 17 | (4, 2) | 3 | 0 | $\mathbb{U}(3) + \mathbb{A}_2(2)$ | $\mathbb{U} + \mathbb{A}_2(2) + \mathbb{A}_1$ | (4, 2) | $\mathbb{U} + \mathbb{A}_2(2)$ | $\mathbb{U}(3) + \mathbb{A}_2(2) + \mathbb{A}_1$ |
| 18 | (6, 2) | 2 | 0 | $\mathbb{U}(2) + 2\mathbb{A}_2$ | $\langle 6 \rangle + \langle -6 \rangle + \mathbb{A}_1$ | (2, 2) | $\mathbb{U}(6)$ | $\mathbb{U} + \mathbb{A}_2 + 2\mathbb{A}_1 + \langle -6 \rangle$ |
| 19 | (6, 2) | 2 | 1 | $\mathbb{U} + \mathbb{A}_2 + \langle -6 \rangle + \mathbb{A}_1$ | $\langle 6 \rangle + \langle -6 \rangle + \mathbb{A}_1$ | (2, 2) | $\langle 6 \rangle + \langle -6 \rangle$ | $\mathbb{U} + \mathbb{A}_2 + 2\mathbb{A}_1 + \langle -6 \rangle$ |
| 20 | (6, 2) | 3 | 1 | $\langle 2 \rangle + 2\mathbb{A}_2 + \langle -6 \rangle$ | $\langle 6 \rangle + 2\mathbb{A}_1$ | (2, 2) | $\langle 6 \rangle + \mathbb{A}_1$ | $\langle 2 \rangle + 2\mathbb{A}_2 + \mathbb{A}_1 + \langle -6 \rangle$ |
| 21 | (3, 3) | 2 | 1 | $\langle 2 \rangle + 2\mathbb{A}_1$ | $\langle 6 \rangle + 2\langle -6 \rangle + \mathbb{A}_2 + \mathbb{A}_1$ | (5, 3) | $\langle 6 \rangle + \mathbb{A}_2 + 2\langle -6 \rangle$ | $\langle 2 \rangle + 3\mathbb{A}_1$ |
| 22 | (3, 3) | 1 | 1 | $\langle 2 \rangle + \langle -6 \rangle + \mathbb{A}_1$ | $\langle 6 \rangle + \langle -6 \rangle + \mathbb{A}_2 + 2\mathbb{A}_1$ | (5, 3) | $\langle 6 \rangle + \mathbb{A}_2 + \mathbb{A}_1 + \langle -6 \rangle$ | $\langle 2 \rangle + 2\mathbb{A}_1 + \langle -6 \rangle$ |
| 23 | (3, 3) | 2 | 1 | $\langle 2 \rangle + 2\langle -6 \rangle$ | $\mathbb{U}(3) + 4\mathbb{A}_1$ | (5, 3) | $\langle 6 \rangle + \mathbb{A}_2 + 2\mathbb{A}_1$ | $\langle 2 \rangle + \mathbb{A}_1 + 2\langle -6 \rangle$ |
| 24 | (5, 3) | 1 | 1 | $\langle 2 \rangle + \mathbb{A}_2 + 2\mathbb{A}_1$ | $\langle 6 \rangle + 2\langle -6 \rangle + \mathbb{A}_1$ | (3, 3) | $\langle 6 \rangle + 2\langle -6 \rangle$ | $\mathbb{U} + \langle -6 \rangle + 3\mathbb{A}_1$ |
| 25 | (5, 3) | 2 | 1 | $\langle 2 \rangle + \mathbb{A}_2 + \langle -6 \rangle + \mathbb{A}_1$ | $\langle 6 \rangle + \langle -6 \rangle + 2\mathbb{A}_1$ | (3, 3) | $\langle 6 \rangle + \mathbb{A}_1 + \langle -6 \rangle$ | $\langle 2 \rangle + \mathbb{A}_2 + 2\mathbb{A}_1 + \langle -6 \rangle$ |
| 26 | (5, 3) | 3 | 1 | $\mathbb{U} + 3\langle -6 \rangle$ | $\langle 6 \rangle + 3\mathbb{A}_1$ | (3, 3) | $\langle 6 \rangle + 2\mathbb{A}_1$ | $\langle 2 \rangle + 2\langle -6 \rangle + \mathbb{A}_2 + \mathbb{A}_1$ |
| 27 | (4, 4) | 0 | 1 | $\langle 2 \rangle + 3\mathbb{A}_1$ | $\langle 6 \rangle + 3\langle -6 \rangle + \mathbb{A}_1$ | (4, 4) | $\langle 6 \rangle + 3\langle -6 \rangle$ | $\langle 2 \rangle + 4\mathbb{A}_1$ |
| 28 | (4, 4) | 1 | 1 | $\langle 2 \rangle + \langle -6 \rangle + 2\mathbb{A}_1$ | $\langle 6 \rangle + 2\langle -6 \rangle + 2\mathbb{A}_1$ | (4, 4) | $\langle 6 \rangle + \mathbb{A}_1 + 2\langle -6 \rangle$ | $\langle 2 \rangle + 3\mathbb{A}_1 + \langle -6 \rangle$ |
| 29 | (4, 4) | 2 | 1 | $\langle 2 \rangle + 2\langle -6 \rangle + \mathbb{A}_1$ | $\langle 6 \rangle + \langle -6 \rangle + 3\mathbb{A}_1$ | (4, 4) | $\langle 6 \rangle + \langle -6 \rangle + 2\mathbb{A}_1$ | $\langle 2 \rangle + 2\mathbb{A}_1 + 2\langle -6 \rangle$ |
| 30 | (4, 4) | 3 | 1 | $\langle 2 \rangle + 3\langle -6 \rangle$ | $\langle 6 \rangle + 4\mathbb{A}_1$ | (4, 4) | $\langle 6 \rangle + 3\mathbb{A}_1$ | $\langle 2 \rangle + \mathbb{A}_1 + 3\langle -6 \rangle$ |
| 31 | (4, 4) | 3 | 0 | $\mathbb{U}(6) + \mathbb{A}_2(2)$ | $\langle 6 \rangle + 4\mathbb{A}_1$ | (4, 4) | $\mathbb{U}(2) + \mathbb{A}_2(2)$ | $\langle 2 \rangle + \mathbb{A}_1 + 3\langle -6 \rangle$ |

8.4. Classification of real Zariski sextics. Given a real Zariski sextic A , we associate to it a geometric involution $c \in C(L, \Delta, h)$ induced on a K3-lattice $L = H_2(\tilde{Y})$ with a conical (Δ, h) -decoration by the ascending real structure, $\text{conj}_{\tilde{Y}}: \tilde{Y} \rightarrow \tilde{Y}$ (see 4.1, 4.8). The homology type $[c] \in C[L, \Delta, h]$ depends only on the deformation class $[A]$ of A , and the mapping $[A] \mapsto [c]$ gives by Theorem 6.3.1 a one-to-one correspondence between the set of deformation classes of real Zariski sextics and the set $C^a[L, \Delta, h] = \{[c] \in C[L, \Delta, h] \mid c \text{ is ascending}\}$. Then we obtain a mapping that sends $[c]$ to the isomorphism type of $(T_+(c), T_-(c))$.

8.4.1. Theorem. *Associating with a real Zariski sextic A the eigenlattices $(T_+(c), T_-(c))$ of $c \in C^a(L, \Delta, h)$ defined by the ascending real structure in \tilde{Y} , we obtain a one-to-one correspondence between the deformation classes of real Zariski sextics and the ascending T -pairs listed in the Tables 8A, 8B and 8C.*

Proof. Theorem 8.1.1 shows injectivity of the map from $C^a[L, \Delta, h]$ to the set of isomorphism types of ascending T -pairs $(T_+(c), T_-(c))$, and Theorem 5.5.6 shows its surjectivity. Theorem 7.7.1 enumerates the ascending T -pairs (they are listed first in Tables 7A-B, and then presented in a different order in Tables 8A-B to fit to our final description of the IDs of real Zariski sextics in Theorem 2.9.1). \square

8.5. The IDs of real Zariski sextics. Our aim now is to obtain from Theorem 8.4.1 an enumeration of the deformation classes of real Zariski sextics A in terms of their IDs. The following lemma describes how the characteristics $\ell(A)$, $\chi(\mathbb{A}_-)$, $\nu_r(A)$, $o(A)$, and the type of A are expressed in terms of the invariants r , r_2 , δ_2 , p and q of $T_+(c)$

8.5.1. Lemma. *The ID of a real Zariski sextic A determines the values r , r_2 , δ_2 , p and q of the eigenlattices $T_\pm \subset L = H_2(\tilde{Y})$ associated with the ascending real structure in \tilde{Y} . Conversely, the values r , r_2 , δ_2 , p and q determine $\ell(A)$, $\chi(\mathbb{A}_n)$, ν_r , the type of A (I or II), and the sign $o(A)$. Namely, if $A(\mathbb{R}) \neq \emptyset$, then the following relations hold.*

- (1) $r_2(T_+) = r_2(T_-) - 1 = 5 - \ell(A)$, $r(T_+) = 9 - r(T_-) = 4 + \chi(\mathbb{A}_n)$,
in particular, in the case of code $\alpha+1\langle\beta\rangle$, we have $r_2(T_+) = 4 - (\alpha+\beta)$, $r(T_+) = 4 + (\beta-\alpha)$,
or equivalently $\alpha = 4 - \frac{r+r_2}{2}$ and $\beta = \frac{r-r_2}{2}$.
- (2) The type of A determines $\delta_2(T_+)$ and is determined by it, namely, $\delta_2(T_+) = 0$ if A has type I, and $\delta_2(T_+) = 1$ if type II.
- (3) The sign $o(A)$ and the number of real cusps, $2\nu_r(A)$, determine $0 \leq p \leq 1$ and $0 \leq q \leq 3$, and conversely, p and q determine $o(A)$ and $2\nu_r$ as follows.

$$(p, q) = \begin{cases} (0, 3 - \nu_r(A)), & \text{if } o(A) = -, \\ (1, \nu_r(A)), & \text{if } o(A) = +, \end{cases} \quad (o(A), \nu_r) = \begin{cases} (-, 3 - q), & \text{if } p = 0, \\ (+, q), & \text{if } p = 1. \end{cases}$$

If $A(\mathbb{R}) = \emptyset$, then $r(T_+) = r_2(T_+) = 4$, $\delta_2(T_+) = 0$, and (p, q) is $(1, 0)$ if $o(A) = -$ and $(0, 3)$ if $o(A) = +$.

Proof. In the case $A(\mathbb{R}) \neq \emptyset$, the ascending involution is the Möbius one, see Lemma 4.8.2. So, the relations for $r_2(T_\pm)$ in (1) follow from Lemma 4.2.1 and Corollary 4.2.4. The relation between $r(T_+)$ and $\chi(\mathbb{A}_n)$ follows from Lemmas 2.8.1 and 4.1.1. Item (2) follows from Proposition 4.3.5, and (3) from Corollary 4.9.4.

In the case of $A(\mathbb{R}) = \emptyset$, the values of r , r_2 and δ_2 for T_+ are found in Lemma 4.10.1, and the relation for (p, q) are obtained from (3) by alternation of the sign $o(A)$, because the ascending real structure is non-Möbius in the case of $A(\mathbb{R}) = \emptyset$. \square

8.5.2. Lemma. *Assume that A is a real Zariski sextic and the covering desingularized K3-surface \tilde{Y} is endowed with the ascending real structure. Then the following conditions are equivalent:*

- (1) $A(\mathbb{R}) = \emptyset$;
- (2) $\tilde{Y}(\mathbb{R}) = \emptyset$;
- (3) the eigenlattice $T_+(c)$ of the involution c induced in $T \subset H_2(\tilde{Y})$ by the real structure is either $\mathbb{U}(2) + \mathbb{A}_2(2)$, or $\mathbb{U}(6) + \mathbb{A}_2(2)$;
- (4) the ascending T-pair $(T_+(c), T_-(c))$ is either the one in the last row of Table 8B, or the one in the last row of Table 8C.

Proof. For $A(\mathbb{R}) \neq \emptyset$, we have $\tilde{Y}(\mathbb{R}) \neq \emptyset$ by definition, and for $A(\mathbb{R}) = \emptyset$ the ascending real structure in \tilde{Y} is the non-Möbius one (see Lemma 4.8.2), with $\tilde{Y}(\mathbb{R}) = \emptyset$, which shows equivalence of (1) and (2).

Lemma 4.10.1 says that (1) implies $r(T_+) = r_2(T_+) = 4$, and $\delta_2(T_+) = 0$. Let $\text{discr}_3 T_+ = p\langle\frac{2}{3}\rangle + q\langle-\frac{2}{3}\rangle$, then $\nu_r = 0$ implies that (p, q) is either $(1, 0)$, or $(0, 3)$ depending on $o(A)$ (see Lemma 8.5.1). These characteristics detect precisely two ascending T-pairs from Tables 7A-B, which are characterized by $T_+(c)$ in (3). Existence of at least two deformation classes of “empty” Zariski sextics A (with $o(A) = \pm$) shows that such T-pairs really correspond to the case of $\tilde{Y}(\mathbb{R}) = \emptyset$. The aforementioned T-pairs are placed in the last rows of Tables 8B and 8C. \square

Remark. Recall that in the case $A(\mathbb{R}) = \emptyset$, the central projection of the cubic surface onto $P^2(\mathbb{R})$ is one-to-one if $o(A) = -$ and three-to-one if $o(A) = +$.

8.5.3. Theorem. *The ID of a real Zariski sextic whose equisingular deformation class is determined by the associated eigenlattices (T_+, T_-) in one of the Tables 8A, 8B, and 8C, is listed in the same row of the Table 1A, 1B, and 1C respectively.*

Proof. It was already shown in 8.5.2 that for a real Zariski sextic A with $A(\mathbb{R}) = \emptyset$ the associated pair (T_+, T_-) is like in the last rows of Tables 8B and 8C (depending on $o(A) \in \{+, -\}$). So, in what follows we assume that $A(\mathbb{R}) \neq \emptyset$ and exclude the last row of Tables 8B-C from consideration.

G.Mikhalkin [M] found 49 complete codes of real Zariski sextics A indicating the topological type of the cubics $X(\mathbb{R})$ whose apparent contours they do represent. As follows from Lemma 2.7.1, $\chi(X(\mathbb{R}))$ together with the complete code of A detect $o(A)$. Thus, using Lemma 8.5.1, one can determine the invariants r , r_2 , p and q for the corresponding lattices T_{\pm} , while $\delta_2(T_+)$ remains unknown, since the type of A was not determined by Mikhalkin. Reviewing Tables 7A-B we can observe that the above invariants r , r_2 , p and q distinguish all the rows there except six pairs of rows. In each of these pairs, lattices T_+ are distinguished by the value of δ_2 .

The ascending T-pairs (T_+, T_-) whose invariants r , r_2 , p and q do not match the real Zariski sextics found by Mikhalkin, appear in the rows 4 and 6 of Table 8A, rows 2, 3, 7, 8 of Table 8B, and rows 1, 2, 5, 6, 7, 13 and 20 of Table 8C.

If we know the ID of a real Zariski sextic A associated with (T_+, T_-) , then we may determine the ID of the one associated with the partner of (T_+, T_-) using Proposition 8.3.4, if there is a non-empty oval in $A(\mathbb{R})$, see Corollary 2.6.2. Tables 8B and 8C are arranged to place the partner pairs (T_+, T_-) in the same rows. The sextics A represented by (T_+, T_-) in rows 1, 5, 6, 13, 20 of Table 8B and rows 3, 8 of Table 8C turn out to have a non-empty oval, so it remains to determine the IDs of A represented by (T_+, T_-) from Table 8A, rows 4 and 6 (since they have no partners), and from Tables 8B and 8C, rows 2 and 7 (since Mikhalkin's examples are missing for the both partners).

In the remaining part of the proof we may suppose that the simple code A looks like $\alpha \sqcup 1\langle\beta\rangle$, since the case of null-code was considered in the beginning and the two cases of 3-nest codes (with different values of $o(A)$) are represented in the row 17 of Tables 8B and 8C, which requires no further analysis (it follows from Lemmas 2.4.2 and 2.5.1 that these are the only IDs with the 3-nest code).

Lemma 8.5.1 shows how to reconstruct from (T_+, T_-) the type of A , $\nu_r(A)$, and $o(A)$. So, it remains only to determine the distribution of the real cusps on the ovals of $A(\mathbb{R})$ to reconstruct its ID.

8.5.4. Lemma. *The real Zariski sextics A characterized by the eigenlattices (T_+, T_-) in rows 4 and 6 of Table 8A and rows 2 and 7 in each of the Tables 8B–8C have IDs indicated in the corresponding rows of Table 1A and 1B–1C respectively.*

Proof. In all the cases indicated A has type II, since $\delta_2(T_+) = 1$. In the case of row 6 of Table 8A, Lemma 8.5.1 says that A has no real cusps and thus, the complete code coincides with the simple one. This Lemma says also that this code is $1\langle 1\rangle$, and determines the sign $o(A) = +$ (since $p = 1$), giving the ID indicated in row 6 of Table 1A.

For row 4 of Table 8A, we get $\nu_r = 1$, the simple code $1\langle 2\rangle$, and $o(A) = -$. Lemma 2.3.1 implies that the both real cusps should lie on the same oval, by Lemma 2.3.2, they must be outward cusps if lying on the ambient oval and inward cusps in lying on an internal one. But the latter case is forbidden by Lemma 2.3.5, so the complete code of A must be $1_1\langle 2\rangle$.

In the case of row 2 of Table 8B, we similarly find $\nu_r = 2$, the sign $o(A) = -$, and the simple code $2\sqcup 1\langle 2\rangle$. Applying Lemmas 2.3.2 and 2.3.5, we conclude that the two pairs of outward cusps must be distributed among the external ovals and the ambient oval. Lemmas 2.3.6 and 2.7.3 exclude a possibility that one of the external ovals is smooth, thus both of them have a pair of cusps and the complete code is $2_1 \sqcup 1\langle 2\rangle$.

In the case of row 7 of Table 8B, we find $\nu_r = 2$, $o(A) = -$, and the simple code $1 \sqcup 1\langle 2 \rangle$. As above, we conclude that there should be two pairs of outward cusps distributed among the ambient and the external ovals. Lemma 2.7.3 exclude possibility that all the cusps lie on the ambient oval, while Lemma 2.3.5 exclude possibility that all the cusps lie on the exterior one. Thus, the complete code must be $1_1 \sqcup 1_1\langle 2 \rangle$.

The rows 2 and 7 of Table 8C represent the reverse partners for the same rows of Table 8B, and thus, the corresponding curves $A(\mathbb{R})$ must be in reverse positions, by Proposition 8.3.4. Since not all the ovals are empty, the complete code of the reverse partners can be found by the rule in Corollary 2.6.2, namely, reversion of $2_1 \sqcup 1\langle 1 \rangle$ gives $1 \sqcup 1\langle 2_1 \rangle$ and reversion of $1_1 \sqcup 1_1\langle 2 \rangle$ gives $2 \sqcup 1_{-1}\langle 1_1 \rangle$, like indicated in Tables 1C. \square

Finally, it remains to analyze the six pairs of rows which differ only by the value of $\delta_2(T_+)$, namely, rows 10 with 11, rows 14 with 15, and rows 18 with 19 in Table 8B, and the same pairs of rows in Table 8C.

8.5.5. Lemma. *Each of the three pairs of rows, 10 with 11, 14 with 15, 18 with 19 in Table 8B, represent a pair of deformation classes of real Zariski sextics A which have the same complete codes. The same is true for the same pairs of rows in Table 8C. The corresponding complete codes are like indicated in the corresponding rows of Tables 1B and 1C.*

Proof. Using Lemma 8.5.1 like in the proof of Lemma 8.5.4, we conclude that the complete codes of A for the indicated pairs of rows may differ only by the distribution of cusps on the ovals, since the values of r , r_2 , p and q for T_+ in each of the pairs of rows is the same.

Rows 10 and 11 of Table 8B give both the simple code 3, with $\nu_r = 3$ and $o(A) = -$, which implies that there are three pairs of outward cusps. None of these three ovals can be smooth by Corollary 2.7.4, so, both rows should give complete code 3_1 .

Rows 14 and 15 give both the simple code $1 \sqcup 1\langle 1 \rangle$, with $\nu_r = 2$, and $o(A) = -$. The sign $o(A)$ together with Lemmas 2.3.2 and 2.3.5 imply that the cusps are outward (cf. the proof of Lemma 8.5.4). An external oval can be neither smooth nor 4-cuspidal by Lemmas 2.7.3 and 2.3.5 respectively. So, the complete code for the both rows is $1_1 \sqcup 1_1\langle 1 \rangle$.

Rows 18 and 19 give the simple code $1\langle 2 \rangle$ with $\nu_r = 1$ and $o(A) = -$. This implies that there is one pair of cusps which must lie on the ambient oval, since Lemmas 2.3.2 and 2.3.5 exclude other possibilities.

The same rows in Table 8C represent the reversion partners for the ones considered above, and thus, their complete code is obtained by reversion, according to the rules in Corollary 2.6.2. \square

As the result, we can deduce that in each of these six pairs, the cusps must be distributed on the ovals in the same way, and thus, the corresponding real Zariski sextics A must have the IDs like indicated in the 1B and 1C. \square

8.6. Proof of Theorem 2.9.1. Theorem 8.4.1 together with the correspondence established in Theorem 8.5.3 imply Theorem 2.9.1. \square

9. CONCLUDING REMARKS

9.1. Purely real statements. Although the ID of a real Zariski sextic refers to its complex point set, it is sufficient to look at the Tables 1A-C to conclude that in the majority of cases the deformation classes are determined only by the complete codes, which are purely real invariants. There are however a few exceptions. The first group of exceptions is given by real Zariski sextics with the complete codes \emptyset , 1 , $1\langle 1 \rangle$, and $1\langle 1\langle 1 \rangle \rangle$. In each of these cases there are 2 deformation classes. But they can be distinguished by enhancing the code with the invariant $o(A) = \pm$, or in other words, marking the domain where the projection of the cubic surface is three-to-one and thus expressing the classification in terms of “purely real” data.

The other group of exceptions contains 6 complete codes, each one again representing 2 deformation classes, but this time the classes in each pair differ by the types, I or II, of the sextics. The only remedy we can suggest to distinguish the types in purely real terms is to use real lines passing through a pair of ovals of the sextic. In one case such lines separate the cusps on the third oval as it is shown on Figure 4, and in the other, they do not.

FIGURE 4. The six pairs of codes that differ only by their type (the bottom pairs are the partners of the top pairs)

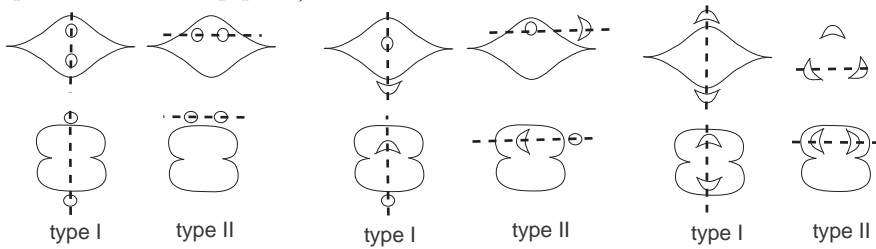
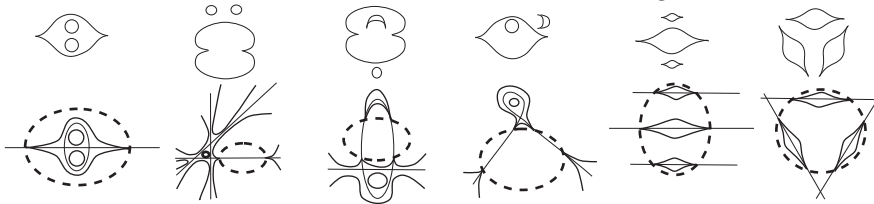

FIGURE 5. Construction of the curves on Figure 4



The proof that the types are as indicated on Figure 4, is based on the construction of these curves shown on Figure 5. Since sextics-partners have the same type, it is sufficient to consider one representative from each pair of partners.

Recall that according to our definitions, a real Zariski sextic is a generic projection of a non-singular real cubic surface, where the latter is supposed to have neither real nor complex singular points and a generic projection is supposed to have no singular points other than ordinary (real or complex) cusps. Therefore, it is natural to ask how the deformation classification of generic visual contours may change if we allow for cubic surfaces to have non-real singular points and for Zariski sextics to have non-real singularities other than cusps. The answer is straightforward, it says that the deformation classification does not change. (However, to make the formulation of the problem and the solution depend only on the real locus of Zariski sextics in question, it is better to exclude the case of sextics with empty real locus; in all the other cases, the real locus is sufficient for extending the real central projection correspondence stated in Proposition 2.2.1 to this new setting.)

9.2. Transversal pairs of conic and cubic. As is known, see Proposition 2.1.4, a Zariski sextic is uniquely defined by a pair of homogeneous polynomials of degree 2 and 3 defining a conic and a cubic intersecting transversely. Thus, it may be worth to ask about deformation classification of such pairs of polynomials. Understanding this question literally, one easily gets the following answer. Over \mathbb{C} , there is only one deformation class. And over \mathbb{R} , there are 4 classes; they are distinguished just by the number of real intersections points : 6, 4, 2, or none.

Curiously enough, the latter result being so far from the principal object of our investigation is however also related to classification of cubic surfaces. Namely, if we impose the assumption

of non-singularity on the conic, then aforesaid transversal pairs describe cubic surfaces with one node. Over \mathbb{C} the pairs of homogeneous polynomials of degree 2 and 3 defining a non-singular conic and a (possibly singular) cubic intersecting its transversely form a single deformation class, while over \mathbb{R} we get 10 deformation classes, more than before, because of the well defined sign of the degree 2 polynomial on the nonorientable part of the complement of the set of its zeros in the real projective plane (now, the sign can not be changed, because we have forbidden to the conic to become singular) and a possibility to have 0 intersection points in two ways, with empty and with non empty conic. As a consequence, real cubic surfaces with one node form 5 deformation classes (twice less, since reversing of the sign of the polynomial of the cubic surface leads to the change of the sign of the polynomial defining the conic); the fact which was observed exactly in this way by F. Klein, who used it as a step to his classification of real nonsingular cubic surfaces up to deformation.

A different, but somehow related and typical problem is the classification of pairs of transversally intersecting nonsingular curves. As was shown by G. Polotovskiy [Pol], in the case of a real conic and a real cubic one obtains 25 deformation classes: each deformation class is determined by the topology of the arrangement of real points in the real projective plane; there are 7 extremal classes shown in Figure 6 and the other ones are obtained from them by two moves: erasing an oval (of the cubic or of the conic) containing no intersection points, and shifting a piece of curve containing a pair of consecutive (both on the conic and the cubic) intersection points, so that these two intersections disappear.

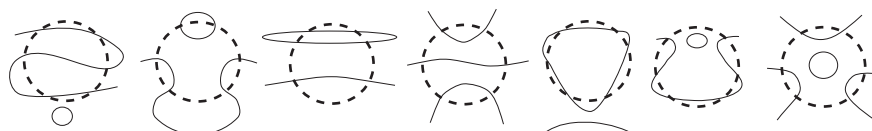

FIGURE 6. The extremal mutual positions of a cubic and a conic

The both classification problems for the pairs formed by a conic and a cubic are different from the problem of classification of Zariski sextics by an evident, although a deep, reason. In the case of Zariski curves there is a more subtle non-singularity condition: the sextic $p^2 + q^3$ should not have singular points other than the intersection points of the conic q with the cubic p .

9.3. Ordering of IDs. To characterize the set of complete codes of Zariski sextics one can give a short list of the extremal ones, from which all the others can be obtained by certain simplifying moves. The extremal codes include seven M-codes, namely, $1\langle 4 \rangle$, $\alpha_1 \sqcup 1\langle \beta \rangle$, and $\alpha \sqcup 1\langle \beta_1 \rangle$, $1 \leq \alpha, \beta \leq 3$, $\alpha + \beta = 4$, the 3-nest code $1\langle 1\langle 1 \rangle \rangle$, and the code $1\langle 1_1 \sqcup 1 \rangle$. The simplifying moves are:

- (1) cancellation of an empty smooth oval (for instance, $2 \sqcup 1\langle 2_1 \rangle$ gives $1 \sqcup 1\langle 2_1 \rangle$),
- (2) cancellation of an empty oval with a pair of outward cusps (for instance, $2 \sqcup 1\langle 2_1 \rangle$ gives $2 \sqcup 1\langle 1_1 \rangle$),
- (3) fusion of an empty oval that has a pair of outward cusps with a principal oval as is shown on Figure 7 (for instance, $2_1 \sqcup 1\langle 2 \rangle$ gives $1_1 \sqcup 1_1\langle 2 \rangle$, while $2 \sqcup 1\langle 2_1 \rangle$ gives $2 \sqcup 1_{-1}\langle 1_1 \rangle$).

All the complete codes of Zariski sextics can be obtained by such moves from the extremal ones. However, one can obtain also a few extra ones, which are not the codes of Zariski sextics. Namely, $1 \sqcup 1_{-3}$, $2 \sqcup 1_{-2}$, and $3 \sqcup 1_{-1}$, are obtained by fusion-move applied to all the internal ovals of $\alpha \sqcup 1\langle (4 - \alpha)_1 \rangle$, $\alpha = 1, 2, 3$. These are the only three exceptions: if we apply simplification moves to any of the extremal codes in any other way, then we necessarily obtain again a code of a Zariski sextic.

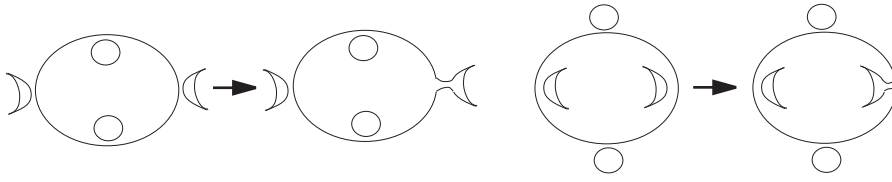

FIGURE 7. Fusion moves

9.4. Nonsingular partners. The partner duality that played an important role in our classification of real Zariski sextics exists as well in the case of nonsingular real sextics. Implicitly, it appears already in Hilbert's sixteenth problem statement. Furthermore, it performed a dramatic and somehow decisive role in Gudkov's classification of real nonsingular sextics. It was the subject of his habilitation thesis, and when he had shown the preliminary version to one of his "thesis referees", V.V. Morosov (Professor at the Kazan University), the latter have objected the resulting classification exactly because of a small irregularity with respect to the "reversion symmetry" in it. It is by repairing this asymmetry that Gudkov has come to his final result. Such a reversion symmetry revealed itself forcefully again in Rokhlin's and Nikulin's treatment of deformation classes of real nonsingular sextics. Up to the best of our knowledge, a conceptual explanation of this partner duality/reversion symmetry was never explicitly presented in the literature. In fact, such an explanation for nonsingular sextics is literarily the same as for Zariski sextics, both in the lattice-arithmetical and in geometric terms. Namely, for each deformation class with one exception, the eigenlattice L_- contains an \mathbb{U} -summand and the lattice-arithmetical form of the partner duality consists in transferring the \mathbb{U} -summand to the opposite eigenlattice L_+ and then exchanging of the eigenlattices. In geometrical terms it means that each partner in a partner pair can be deformed to a triple conic, near the triple conic the family looks as $Q^3 + tf_2Q^2 + t^2f_4Q + f_6 = 0$ (cf., Introduction), and switching of the sign of t (which corresponds to passing through the triple conic) replaces the curves from one deformation class by the curves from its partner class. The only exceptional deformation class having no partner class is formed by real sextics of type I with the code $1\langle 4 \rangle$.

9.5. Polygamy. In the case of real sextics with arbitrary singularities, the partner relation turns out to be a sort of polygamy, as one can observe already in the case of sextics with a node (cf., [It]). There is however a well-defined partnership map (neither injective nor surjective) on the deformation classes of real sextics with an *internal node* to the ones with an *external node* as is illustrated on Figure 8.

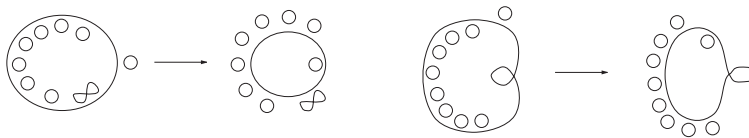

FIGURE 8. The partnership map for real nodal sextics

*If we shadows have offended,
Think but this, and all is mended,
That you have but slumber'd here
While these visions did appear.
And this weak and idle theme,
No more yielding but a dream,
Gentles, do not reprehend:*

if you pardon, we will mend ...

“Midsummer Night Dream”, W. Shakespeare

REFERENCES

- [A] V. I. Arnold, *On the teaching mathematics*, Russian Math. Surveys **53** (1998), no. 1, 229–236.
- [BLLV] J. Barge, J. Lannes, F. Latour, P. Vogel, Λ -spheres, Annales scientifiques de l’Ecole Normale Supérieure, Sér. 4 **7** (1974), no. 4, 463–505.
- [BR] D. Burns, M. Rappaport, *On the Torelli problem for kählerian K3 surfaces*, Annales scientifiques de l’Ecole Normale Supérieure, Sér. 4 **8** (1975), no. 2, 235–273.
- [D1] A. Degtyarev, *Oka’s conjecture on irreducible plane sextics*, J. London Math. Soc. **78** (2008), no. 2, 329–351.
- [D2] A. Degtyarev, *On deformations of singular plane sextics*, J. Algeb. Geom. **17** (2008), 101–135.
- [G] D. A. Gudkov, *The topology of real projective algebraic varieties*, Russian Math. Surveys **29** (1974), no. 4, 1–79.
- [GM] L. Guilou, A. Marin, *A la recherche de la topologie perdue*, Birkhauser, 1986, pp. 97–118.
- [It] I. Itenberg, *Rigid isotopy classification of curves of degree 6 with one nondegenerate double point*, Adv. in Sov. Math. **18** (1994), 193–208.
- [J] D. G. James, *Diagonalizable indefinite integral quadratic forms*, Acta Arith. **50** (1988), 309–314.
- [Kh1] V. Kharlamov, *New congruences for the Euler characteristic of real algebraic varieties*, Funkz. Anal. i Priloz. (1973), no. 2, 74–78.
- [Kh2] V. Kharlamov, *Topological types of real nonsingular surfaces of degree 4 in $\mathbb{R}P^3$* , Funkz. Anal. i Priloz. (1976), no. 4, 55–68.
- [Ku1] Vik. Kulikov, *On Chisini’s conjecture*, Izv. Math. **63** (1999), no. 6, 1139–1170.
- [Ku2] Vik. Kulikov, *Surjectivity of the period map for a K3 surface*, Usp. Mat. Nauk **32** (1977), no. 4, 257–258.
- [M] G. Mikhalkin, *Visible contours of cubic surfaces in $\mathbb{R}P^3$* , Preprint MPI (1995), no. 95-34, 1–8.
- [Mo] Moishezon, *Stable branch curves and braid monodromies*, Lecture Notes in Math. **862** (1981), 107192.
- [N1] V. V. Nikulin, *Integer quadratic forms and some of their geometrical applications*, Math. USSR – Izv. **43** (1979), 103–167.
- [N2] V. V. Nikulin, *Discrete reflection groups in Lobachevsky spaces and algebraic surfaces*, Proceedings of the International Congress of Mathematicians (1986, Berkeley, Calif.), 1987, pp. 654–671.
- [N3] V. V. Nikulin, *Involutions of integer quadratic forms and their applications to real algebraic geometry. (Russian)*, Izv. Akad. Nauk SSSR Ser. Mat. **47** (1983), no. 1, 109–188..
- [Pol] G. M. Polotovskiy, *Full classification of M-decomposable real curves of order 6 in real projective plane. (Russian)*, Dep. VINITI (1978), no. 1349-78, 1–103.
- [Sal] G. Salmon, *A Treatise on the Analytic Geometry of Three Dimensions*, Hodge, Smith, & Co., 1982.
- [SD] B. Saint-Donat, *Projective models of K-3 surfaces*, Am. J. Math. **96** (1974), 602–639.
- [VdB] F. Van der Blij, *An invariant of quadratic forms modulo 8*, Indag/ Math. **21** (1959), 291–293.
- [W1] C.T.C.-Wall, *Quadratic forms in finite groups and related topics*, Topology **2** (1964), 281–298..
- [W2] C.T.C.Wall, *On the Orthogonal Groups of Unimodular Quadratic Forms*, Math Annalen **147** (1962).
- [Z1] O. Zariski, *On the Problem of Existence of Algebraic Functions of Two Variables Possessing a Given Branch Curve.*, American Journal of Mathematics **51** (1929), no. 2, 305–328.
- [Z2] O. Zariski, *Algebraic Surfaces*, Ergebnisse der Mathematik und ihrer Grenzgebiete, Springer, 1935.

MIDDLE EAST TECHNICAL UNIVERSITY, DEPARTMENT OF MATHEMATICS
ANKARA 06800 TURKEY

UNIVERSITÉ DE STRASBOURG ET IRMA (CNRS)
7 RUE RENÉ DESCARTES 67084 STRASBOURG CEDEX, FRANCE