

Max-Planck-Institut für Mathematik Bonn

Tropical eigenwave and intermediate Jacobians

by

Grigory Mikhalkin
Ilia Zharkov

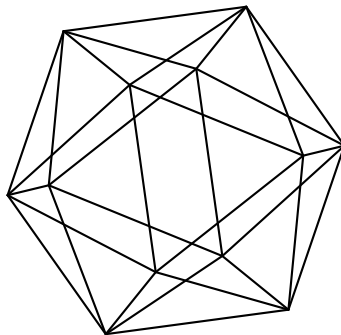

Tropical eigenwave and intermediate Jacobians

Grigory Mikhalkin
Ilia Zharkov

Max-Planck-Institut für Mathematik
Vivatsgasse 7
53111 Bonn
Germany

Université de Genève
Mathématiques
Villa Battelle
1227 Carouge
Switzerland

Kansas State University
138 Cardwell Hall
Manhattan, KS 66506
USA

TROPICAL EIGENWAVE AND INTERMEDIATE JACOBIANS

GRIGORY MIKHALKIN AND ILIA ZHARKOV

ABSTRACT. Tropical manifolds are polyhedral complexes enhanced with certain kind of affine structure. This structure manifests itself through a particular cohomology class which we call the eigenwave of a tropical manifold. Other wave classes of similar type are responsible for deformations of the tropical structure.

If a tropical manifold is approximable by a 1-parametric family of complex manifolds then the eigenwave records the monodromy of the family around the tropical limit. With the help of tropical homology and the eigenwave we define tropical intermediate Jacobians which can be viewed as tropical analogs of classical intermediate Jacobians.

1. TROPICAL SPACES AND TROPICAL MANIFOLDS

In this section we briefly recall basic concepts of tropical spaces relevant for our paper. For more details we refer to [Mik06] and [MR12]. The main assumption we make is that our the tropical space is regular at infinity.

1.1. Tropical spaces. A tropical affine n -space \mathbb{T}^n is the topological space $[-\infty, \infty)^n$ (homeomorphic to the n th power of a half-open interval) enhanced with a collection of functions $\mathcal{O}_{\text{pre}} = \{f\}$, $f : U \rightarrow \mathbb{T} = [-\infty, \infty)$. Here $U \subset \mathbb{T}^n$ is an open set and f is a function that can be expressed as

$$(1.1) \quad f(x) = \max_{j \in A} (jx + a_j)$$

for a finite set $A \subset \mathbb{Z}^n$ and a collection of numbers $a_j \in \mathbb{T}$, such that the scalar product jx is well-defined as a number in \mathbb{T} (i.e. is finite or $-\infty$) for any $x \in U$.

The collection of functions \mathcal{O}_{pre} is a presheaf which gives rise to a sheaf \mathcal{O} of *regular functions* on \mathbb{T}^n (which we will also denote $\mathcal{O}_{\mathbb{T}^n}$ indicating the space where it is defined to avoid ambiguity). \mathcal{O} is called the *structure sheaf* on \mathbb{T}^n .

It is convenient to stratify the space \mathbb{T}^n by

$$\mathbb{T}_I^\circ := \{y \in \mathbb{T}^n : y_i = -\infty, i \in I \text{ and } y_i > -\infty, i \notin I\},$$

where $I \subset \{1, \dots, n\}$. Each T_I° is isomorphic to $\mathbb{R}^{n-|I|}$ and we set \mathbb{T}_I to be its closure in \mathbb{T}^n .

Research is supported in part by the NSF FRG grant DMS-0854989 (G.M. and I.Z.), the TROPGEO project of the European Research Council (G.M.) and the Swiss National Science Foundation grants 140666 and 141329 (G.M.).

To write down a regular function (1.1) on \mathbb{R}^n all we need is the *integral affine structure* on \mathbb{R}^n . This allows us to distinguish functions $\mathbb{R}^n \rightarrow \mathbb{R}$ which are affine with linear parts defined over \mathbb{Z} . Thus the tropical structure on \mathbb{T}^n can be thought of as an extension of the integral affine structure in \mathbb{R}^n where the overlapping maps are compositions of linear transformations in \mathbb{R}^n defined over \mathbb{Z} with arbitrary translations in \mathbb{R}^n .

Given a subset $U \subset \mathbb{T}^N$ we say that a *continuous* map $U \rightarrow \mathbb{T}^M$ is *integral affine* if it restricts to an affine map $\mathbb{R}^N \rightarrow \mathbb{R}^M$ with integral linear part. We say that a partially defined map $h : \mathbb{T}^N \dashrightarrow \mathbb{T}^M$ is integral affine if it is defined on a subset $U \supset \mathbb{R}^N$ and is integral affine there. Extending h whenever we can by continuity we see that for each $I \subset \{1, \dots, N\}$ h is defined everywhere or nowhere on \mathbb{T}_I° .

The automorphisms of a subset $U \subset \mathbb{T}^N$ are invertible integral affine maps $U \rightarrow U$. For example, the automorphisms $\text{Aut}(\mathbb{R}^N) \cong \text{GL}_N(\mathbb{Z}) \ltimes \mathbb{R}^N$ form a group of all integral affine transformations of \mathbb{R}^N while $\text{Aut}(\mathbb{T}^N) \cong \mathbb{R}^N$ only consists of translations. We also note that automorphisms of $\mathbb{T}^s \times \mathbb{R}^{N-s}$ translate an s -dimensional affine subspace of \mathbb{R}^N parallel to the \mathbb{T}^s factor to another one with the same property.

A *convex polyhedral domain* D in \mathbb{T}^N is defined as the intersection of a finite collection of half-spaces H_k of the form

$$(1.2) \quad H_k = \{x \in \mathbb{T}^N \mid jx \leq a\} \subset \mathbb{T}^N$$

for some $j \in \mathbb{Z}^N$ and $a \in \mathbb{R}$. The boundary ∂H_k is given by the equation $jx = a$. A *mobile face* E of D is the intersection of D with the boundaries of some of its defining half-spaces given by (1.2). The adjective *mobile* stands here to distinguish such faces among more general faces of X which we will define later and which are allowed to have support in $\mathbb{T}^N \setminus \mathbb{R}^N$, i.e. be disjoint from $\mathbb{R}^N \subset \mathbb{T}^N$. (They have reduced mobility and are called *sedentary*).

The *dimension* of a convex polyhedral domain D is its topological dimension. Observe that for each mobile face E of D the intersection

$$E^\circ = E \cap \mathbb{R}^N$$

is non-empty. The intersection E° is called the non-infinite part of a mobile face. Each mobile face of D is a convex polyhedral domain itself (although perhaps of smaller dimension).

We say two domains $D \subset \mathbb{T}^N$ and $D' \subset \mathbb{T}^M$ are isomorphic if there is an integral affine map $\mathbb{T}^N \dashrightarrow \mathbb{T}^M$ which restricts to a homeomorphism $D \rightarrow D'$ (in particular, it has to be defined everywhere on D).

We say that a convex polyhedral domain $D \subset \mathbb{T}^N$ is *regular at infinity* if for every $I \subset \{1, \dots, N\}$ the intersection $D \cap (\mathbb{T}_I^\circ)$ is either empty or is a $(\dim D - |I|)$ -dimensional polyhedral domain in $\mathbb{T}_I^\circ \cong \mathbb{R}^{N-|I|}$.

Definition 1.1. An n -dimensional polyhedral complex $Y = \bigcup D \subset \mathbb{T}^N$ is the union of a finite collection of convex n -dimensional polyhedral domains D , called the *facets* of Y subject to the following property. For any collection $\{D_j\}$ of facets,

their intersection $\bigcap D_j$ is a face of each D_j . Such intersections are called the (mobile) faces of Y . Clearly they are themselves polyhedral domains in \mathbb{T}^N .

We say that Y is regular at infinity if all its faces are regular at infinity.

In this paper we assume that all polyhedral complexes are regular at infinity.

Condition (Balancing). Let E be an $(n - 1)$ -dimensional mobile face in Y and $D_1, \dots, D_l \subset \mathbb{T}^N$ be the facets adjacent to E . Take the quotient of \mathbb{R}^N by the linear subspace parallel to E° , the non-infinite part of E . The balancing condition requires that

$$(1.3) \quad \sum_{k=1}^l \epsilon_k = 0,$$

where the ϵ_k are the outward primitive integer vectors parallel to the images of D_k in this quotient.

A polyhedral complex $Y \subset \mathbb{T}^N$ is called *balanced* if all of its $(n - 1)$ -dimensional faces satisfy the balancing condition.

More generally we can consider spaces that locally look like balanced polyhedral complexes, i.e. admit a covering by open sets U_α enhanced with open embeddings (charts)

$$\phi_\alpha : U_\alpha \rightarrow Y_\alpha \subset \mathbb{T}^{N_\alpha}$$

where each $Y_\alpha \subset \mathbb{T}^{N_\alpha}$ is a balanced polyhedral complex. In this paper we assume in addition that each Y_α is regular at infinity.

We may express compatibility of different charts by requiring that the corresponding overlapping maps are induced by integral affine maps $\mathbb{T}^{N_\alpha} \dashrightarrow \mathbb{T}^{N_\beta}$. Or, equivalently, we may use the structure sheaf and enhance each $Y_\alpha \subset \mathbb{T}^{N_\alpha}$ with the sheaf \mathcal{O}_{Y_α} induced from $\mathcal{O}_{\mathbb{T}^{N_\alpha}}$. Its pull-back under ϕ_α is a sheaf on U_α . Two charts ϕ_α and ϕ_β are compatible if the corresponding restrictions to $U_\alpha \cap U_\beta$ agree.

We arrive to the following definition of a tropical space.

Definition 1.2 (cf. [MR12]). A tropical space is a topological space X enhanced with a cover of compatible charts $\phi_\alpha : U_\alpha \rightarrow Y_\alpha \subset \mathbb{T}^{N_\alpha}$ to balanced polyhedral complexes as above and which satisfies the finite type condition below.

The tropical space X is regular at infinity if it admits charts to polyhedral complexes regular at infinity.

The charts induce a sheaf \mathcal{O}_X on X which we call the structure sheaf of X .

Condition (Finite type). The number of charts ϕ_α covering X is finite while each chart is subject to the following property. If $\{x_j \in U_\alpha\}_{j=1}^\infty$ is a sequence such that $\phi_\alpha(x_j)$ converges to a point $y \in \mathbb{T}^{N_\alpha}$ then either the sequence $\{x_j\}$ converges inside the topological space X or there exists a coordinate in \mathbb{T}^{N_α} such that its value on y is $-\infty$ while its value on any point in $\phi_\alpha(U_\alpha)$ is finite.

It is easy to see that this finite type condition is a reformulation of the one from [MR12].

1.2. Sedentary points and faces. Let $D \subset \mathbb{T}^N$ be a polyhedral domain. It is convenient to treat the intersections $D \cap \mathbb{T}_I$ for $I \subset \{1, \dots, N\}$ also as its faces (at infinity). If we need to distinguish such faces from the mobile ones we have defined before we call these new faces *sedentary*.

Definition 1.3. We say that

$$E_I := E \cap \mathbb{T}_I$$

is a face of D if E is a mobile face of D . The *sedentarity* of the face E_I is $s = |I|$, while its *refined sedentarity* is I .

Clearly, the mobile faces (defined previously) are the faces of sedentarity 0. If $Y \subset \mathbb{T}^M$ is a polyhedral complex then we define a (possibly sedentary) face of Y as a face of a facet in Y .

We will use the notation $F \prec_j^s E$ when F is a face of E of codimension j and sedentarity s higher. It is also convenient to introduce the following terminology.

Definition 1.4. A face E of Y is called *infinite* if either it is not compact or it contains a higher sedentary subspace. Otherwise E is called *finite* (even if the sedentarity of E itself is positive).

Note that even though a face $F \subset Y$ of sedentarity I may be adjacent to several facets, it is always presented as

$$F = E \cap \mathbb{T}^I$$

for a unique mobile face $E \subset Y$ which we call the *parent* of F (as long as Y is regular at infinity). The set of faces of Y with the same parent E is called the *family* of E . In case E is compact the regularity at infinity forces its family to have a very simple combinatorial structure.

Proposition 1.5. *Let $E \subset Y$ be a compact mobile face containing a face of a maximal sedentarity s . Then its family $\Pi(E)$ forms a lattice poset (under \prec_j^s), isomorphic to the face poset of a simplicial cone of dimension s . The maximal sedentary face in the poset is finite.*

Note also that a face F of sedentarity I completely determines the integral affine structure of its parent face E in the neighborhood of \mathbb{T}_I . Namely, we have the following proposition.

Proposition 1.6. *Let $\pi_I : \mathbb{T}^N \rightarrow \mathbb{T}^I$ be the projection taking a point (x_1, \dots, x_N) to the point whose j -th coordinate is x_j if $j \notin I$ and $-\infty$ otherwise. The parent face E of F is contained in $\pi_I^{-1}(F)$. Furthermore, for a small open neighborhood $U \supset \mathbb{T}_I$ we have*

$$E \cap U = \pi_I^{-1}(F) \cap U.$$

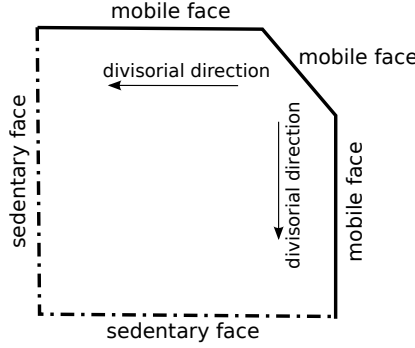

FIGURE 1. Mobile and sedentary faces of a polyhedral domain in \mathbb{T}^N .

In other words for a sufficiently small $\epsilon > -\infty$ we have $(x_1, \dots, x_N) \in E$ whenever $\pi_I(x_1, \dots, x_N) \in F$ and $x_j < \epsilon$ for any $j \in I$. Thus the directions parallel to the j -th coordinate in \mathbb{T}^N for $j \in I$ are quite special for E . We orient them toward the $-\infty$ -value of the coordinate and call them *divisorial directions*, see Figure 1. Their positive linear combinations span the *divisorial cone* while all linear combination span the *divisorial subspace* in \mathbb{R}^N . The primitive integral vector along a divisorial direction (pointing towards $-\infty$ as the direction itself) is called a *divisorial vector*.

One important observation is that the divisorial vectors are invariant with respect to any integral affine automorphism of $\mathbb{T}^{|I|} \times \mathbb{T}_I^\circ$. Thus they are intrinsically defined for F and so is the divisorial subspace which we denote by W^{div} .

1.3. Tangent spaces. Let y be a point in the relative interior of a face F of sedentarity I in a balanced polyhedral complex $Y \subset \mathbb{T}^N$. Let $\Sigma(y)$ be the cone in $\mathbb{T}_I^\circ \cong \mathbb{R}^{N-|I|}$ consisting of vectors $u \in \mathbb{T}_I^\circ$ such that $y + \epsilon u \in Y \cap \mathbb{T}_I^\circ$ for a sufficiently small $\epsilon > 0$ (depending on u). We denote the intersection of all maximal linear subspaces contained in $\Sigma(y)$ by $W'(y)$.

Clearly, the cones $\Sigma(y)$ can be canonically identified for all points y in the relative interior of the same face, and so can be the vector spaces $W'(y)$. We say that $y_m \in Y$ is a *nearby mobile point* to y if y_m belongs to the relative interior of the parent face to F .

Definition 1.7. For a point $y \in Y$ we define $W(y)$, the *wave tangent space* at y , as $W'(y_m)$ for a nearby mobile point y_m . The (conventional) tangent space $T(y)$ at y is defined as the linear span of $\Sigma(y)$ in $\mathbb{T}_I^\circ \cong \mathbb{R}^{N-|I|}$, where I is the refined sedentarity of y .

Note that there are two essential distinctions in defining $T(y)$ and $W(y)$. To define $W(y)$ we always move to a nearby mobile point y_m . The space $W'(y)$ itself, is naturally a quotient of $W(y)$ by the divisorial subspace $W^{div}(y)$.

On the other hand, for $T(y)$ we work in a vector space \mathbb{T}_I° , which is naturally the quotient $\mathbb{R}^N/W^{\text{div}}(y)$, but we take the linear span of the cone instead of the vector space contained in it.

If we need to specify the space Y for the tangent space $T(y)$ we write $T_Y(y)$, and similarly for $W(y)$. The following proposition is straightforward.

Proposition 1.8. *An integral affine map $h : \mathbb{T}^N \dashrightarrow \mathbb{T}^M$ induces linear maps $dh^W : W_Y(y) \rightarrow W_{h(Y)}(h(y))$ and $dh^T : T_Y(y) \rightarrow T_{h(Y)}(h(y))$ whenever h is well-defined on y . We call these maps differentials of h .*

The differentials are natural in the following sense. If $g : \mathbb{T}^M \dashrightarrow \mathbb{T}^L$ is another integral affine map defined on $h(y)$, then the induced differentials satisfy $d(g \circ h) = (dg) \circ (dh)$.

Let $x \in X$ be now a point in a tropical space.

Corollary 1.9. *The tangent spaces $W_{Y_\alpha}(\phi_\alpha(x))$ (resp. $T_{Y_\alpha}(\phi_\alpha(x))$) for different charts ϕ_α are identified by the differentials of the overlapping maps. The resulting spaces $W(x)$ and $T(x)$ are called the wave tangent space and the (conventional) tangent space to the tropical space X at its point x .*

The tangent spaces $T(x)$ and $W(x)$ carry natural integral structure. We denote the corresponding lattices by $T_{\mathbb{Z}}(x)$ and $W_{\mathbb{Z}}(x)$.

1.4. Polyhedral structures. Sometimes a tropical space X comes with a structure of an (abstract) polyhedral complex, which is not always the case.

Definition 1.10. We say that a tropical space X is *polyhedral* if there are finitely many closed subsets $\Delta_j \in X$ (called *facets*) with the following properties.

- For each Δ_j there exists a chart such that $\Delta_j \subset U_\alpha$ and $\phi_\alpha(\Delta_j)$ is a facet of the balanced polyhedral complex $Y_\alpha \subset \mathbb{T}^{N_\alpha}$.
- For any collection $\{\Delta_j\}$ of facets of X and any face Δ_j in this collection the intersection $\bigcap \Delta_j$ is a face of Δ_j .

Note that we may work with tropical polyhedral spaces in the same way as we work with balanced polyhedral complexes in \mathbb{T}^N . In particular, we can define in the same way their faces (which will denote by Δ), both mobile and sedentary, parent faces with their families, divisorial directions, and any other notion which is intrinsically defined, that is stable under allowed integral affine maps. For instance, Proposition 1.5 will read:

Proposition 1.11. *Let X be a compact polyhedral tropical space. For every face Δ of sedentarity s there is a unique (parent) face Δ_0 of sedentarity 0 such that $\Delta \prec_s^s \Delta_0$. The cells of X with the same Δ_0 , the family of Δ_0 , form a lattice poset $\Pi(\Delta_0)$ isomorphic to the face poset of a simplicial cone. Every face of X belongs to exactly one family poset Π . The maximal sedentary face Δ_{\min} in a poset is finite.*

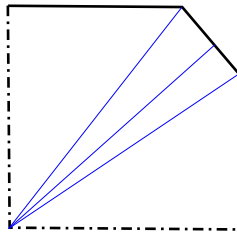

FIGURE 2. Baricentric subdivision of an infinite cell. The dotted faces have higher sedentarity.

We will denote the k -skeleton of a polyhedral tropical space X (that is the union of $(\leq k)$ -dimensional faces) by $\text{Sk}_k(X)$. It is often convenient to take the covering $\{U_\alpha\}$ by open stars of vertices. That is, each U_v is the union of relative interiors of faces of X adjacent to the vertex v . Then the relative interior of a face Δ is contained in every U_v if v is a vertex of Δ .

Another useful feature of a compact polyhedral tropical space is that we can define its first baricentric subdivision. For a finite cell we take an arbitrary point in its interior for its baricenter. For an infinite cell we take for its baricenter the baricenter of its unique most sedentary (necessarily finite, cf. Proposition 1.11) subface (see Figure 2). That is, we first choose baricenters of maximal sedentary faces and then name them also as baricenters of any adjacent faces of lower sedentarity. The subdivision of each face of X into simplices is constructed as usual by the flags of its subfaces of *minimal* sedentarity.

The baricentric subdivision of X is *not* a polyhedral tropical space as we defined it. It violates the regularity at infinity property. Nevertheless, it is very convenient to have a triangulation of X . This enables us to define simplicial versions of the (co)homology theories which are very useful for carrying out explicit calculations.

1.5. Combinatorial stratification. Notice that a polyhedral structure on a tropical space (if it exists) is in no way unique. In this subsection we define a combinatorial stratification which is not always polyhedral, but is naturally defined on any tropical space X .

Definition 1.12. We say that two points $x, x' \in X$ are *combinatorially equivalent* if there exists a path connecting x to x' along which both the dimension of the wave tangent space W and the sedentarity remain constant. A *combinatorial stratum* of the tropical space X is a class of combinatorial equivalence.

We will denote combinatorial strata of X by \mathcal{E} and use the notation $\mathcal{E} \prec \mathcal{E}'$ if the stratum \mathcal{E} lies on the boundary of \mathcal{E}' .

Example 1.13. Consider the circle E_l of length l , otherwise called a *tropical elliptic curve*. E_l is a tropical space: we can present it as a tropical polyhedral space by

choosing, e.g., three distinct points so that they split E_l into three facets. This subdivision is not unique as we can move these points around or consider a subdivision into a larger number of facets. The combinatorial stratification for E_l is trivial: it consists of a single stratum E_l .

Let two points $x, y \in U_\alpha \subset X$ belong to one chart $\phi : U_\alpha \rightarrow Y$ of X and they sit in some strata $x \in \mathcal{E}_x$ and $y \in \mathcal{E}_y$. If $\mathcal{E}_x = \mathcal{E}_y$, that is if they belong to the same stratum, one can canonically identify the tangent spaces $T(y) = T(x)$ and $W(x) = W(y)$. The identification is natural in the following sense. If the points also belong to another common covering open subset U_β it commutes with the differentials induced by the overlapping map.

In other words, we get flat connections on the bundles T and W over each combinatorial stratum of X .

Furthermore, if $\mathcal{E}_x \prec \mathcal{E}_y$ then one has two natural maps

$$(1.4) \quad \iota : T_{\mathbb{Z}}(y) \rightarrow T_{\mathbb{Z}}(x) \text{ and } \pi : W_{\mathbb{Z}}(x) \rightarrow W_{\mathbb{Z}}(y),$$

(note the different directions) defined as follows. If $I(\phi(y)) = I(\phi(x))$ then any face adjacent to $\phi(x)$ is contained in some face adjacent to $\phi(y)$ and ι is given by inclusion. If $I(\phi(y)) \neq I(\phi(x))$ (note that we must have $I(\phi(y)) \subset I(\phi(x))$) then ι is the projection along the divisorial directions indexed by $I(\phi(x)) \setminus I(\phi(y))$. The map π is given by inclusion of the linear spaces spanned by the corresponding parent faces.

Again the maps ι and π are natural in the sense that they commute with the overlapping differentials.

1.6. Tropical manifolds. First we recall a construction of a balanced polyhedral fan associated to a matroid ([AK06], see also e.g. [Sh12], [MR12]).

A matroid $M = (M, r)$ is a finite set M together with a rank function $r : 2^M \rightarrow \mathbb{Z}_{\geq 0}$ such that we have the inequalities $r(A \cup B) + r(A \cap B) \leq r(A) + r(B)$ and $r(A) \leq |A|$, where $|A|$ is the number of elements in A , for any subsets $A, B \subset M$ as well as the inequality $r(A) \leq r(B)$ whenever $A \subset B$. Subsets $F \subset M$ such that $r(A) > r(F)$ for any $A \supset F$ are called *flats* of M of rank $r(F)$. Matroid M is *loopless* if $r(A) = 0$ implies $A = \emptyset$.

The so-called *Bergman fan* of a loopless matroid M is a polyhedral fan $\Sigma_M \subset \mathbb{R}^{|M|-1}$ constructed as follows. Choose $|M|$ integer vectors $e_j \in \mathbb{Z}^{|M|-1} \subset \mathbb{R}^{|M|-1}$, $j \in M$ such that $\sum_{j \in M} e_j = 0$ and any $|M| - 1$ of these vectors form a basis of $\mathbb{Z}^{|M|-1}$.

To any flat $F \subset M$ we associate a vector

$$e_F := \sum_{j \in F} e_j \in \mathbb{R}^{|M|-1}.$$

E.g, $e_M = e_\emptyset = 0$, but $e_F \neq 0$ for any other (proper) flat F . To any flag of flats $F_{i_1} \subset \dots \subset F_{i_k}$ we associate a convex cone generated by $e_{F_{i_j}}$. We define Σ_M to be the

union of such cones, which is, clearly, an $(r(M) - 1)$ -dimensional integral simplicial fan. It is easy to check (cf. [AK06]) that it satisfies the balancing condition, so that Σ_M is a tropical space, called the *Bergman fan* of M .

The matroid M is called *uniform* if $r(A) = |A|$ for any $A \subset M$. Note that the Bergman fan of a uniform matroid is a complete unimodular fan in $\mathbb{R}^{|M|-1}$ with $|M|$ maximal cones.

Definition 1.14. A tropical space X is called *smooth*, or a *tropical manifold*, if all its charts ϕ_α are open embeddings to $Y_\alpha = \Sigma_M \times \mathbb{T}^s \subset \mathbb{T}^{|M|-1} \times \mathbb{T}^s$ for some loopless matroid M and a number $s \geq 0$. (Here s is the maximal sedentarity in this chart and $n = r(M) - 1 + s$ is the dimension of our tropical manifold X .)

Tropical manifolds can be thought of as tropical spaces without points of multiplicity greater than 1, see [MR12], thus we use the term *smooth*. Note that smoothness is a property of the tropical space (X, \mathcal{O}_X) alone, it does not involve presentation of X as a polyhedral complex.

2. HOMOLOGY GROUPS

2.1. Singular tropical homology. Let $x \in X$ be a point in a tropical space. Choose a sufficiently small open set $U \ni x$ and an embedding $\phi : U \rightarrow Y \subset \mathbb{T}^N$. Then for points y such that $\phi(y)$ lies in an adjacent face to $\phi(x)$ we have a natural map between lattices in the tangent spaces $\iota : T_{\mathbb{Z}}(y) \rightarrow T_{\mathbb{Z}}(x)$, cf. (1.4).

Definition 2.1. The group $\mathcal{F}_k(x)$ is defined as the subgroup of the k th exterior power $\Lambda^k(T_{\mathbb{Z}}(x))$ generated by the products $\iota(v_1) \wedge \cdots \wedge \iota(v_k)$ with $v_1, \dots, v_k \in T_{\mathbb{Z}}(y)$ for a point y such that $\phi(y)$ lies in an adjacent face to $\phi(x)$ of the same sedentarity. It is important that all k elements v_j come from a single adjacent face. The group $\mathcal{F}^k(x)$ is defined as $\text{Hom}(\mathcal{F}_k(x), \mathbb{Z})$.

The discussion at the end of Section 1.5 tells us that the groups $\mathcal{F}_k(x)$ and $\mathcal{F}_k(y)$ are canonically identified if x and y belong a single chart U_α and lie in a single stratum \mathcal{E} of X . Furthermore, if for two points x, y , still in the same chart, we have $\mathcal{E}_x \succ \mathcal{E}_y$, then there are natural homomorphisms

$$(2.1) \quad \iota : \mathcal{F}_k(x) \rightarrow \mathcal{F}_k(y).$$

If three points $x, y, z \in U$ lie in the strata with incidence $\mathcal{E}_x \succ \mathcal{E}_y \succ \mathcal{E}_z$ then the three corresponding maps (2.1) form a commutative diagram. In other words, if we consider the set of strata in the $U_\alpha \subset X$ as a category (under inclusions) then \mathcal{F}_k forms a contravariant functor from strata of U_α to abelian groups (cf. Proposition 2.7).

We may interpret our data as a system of coefficients suitable to define singular homology groups on X . Namely, we consider the finite formal sums

$$\sum \beta_\sigma \sigma,$$

where each $\sigma : \Delta \rightarrow X$ is a singular q -simplex which has image in a single chart U_σ and is such that for each relatively open face Δ' of Δ the image $\sigma(\Delta')$ is contained in a single combinatorial stratum $\mathcal{E}_{\Delta'}$ of X . Slightly abusing the notations we'll identify the source and the image of σ with the singular simplex σ itself and say that $\tau = \sigma|_{\Delta'}$ is a face of σ . Here $\beta_\sigma \in \mathcal{F}_k(\mathcal{E}_\Delta \cap U_\sigma)$.

These chains form a complex $C_\bullet(X; \mathcal{F}_k)$ with the differential ∂ given by the standard singular differential followed by the maps 2.1. We call such compatible singular chains with coefficients in \mathcal{F}_k *tropical chains*. The groups

$$H_{p,q}(X) = H_q(C_\bullet(X; \mathcal{F}_p), \partial)$$

are called the *tropical homology groups*.

These homology groups is a version of singular homology groups of a topological space X (after imposing the condition of compatibility of singular chains with the charts and combinatorial strata).

A priori the groups $H_{p,q}(X)$ depend on the covering. Indeed, if we refine the covering the tropical chains will be more restrictive. However the usual chain homotopy arguments apply and show that the resulting homology groups are canonically isomorphic. Thus we can conclude that the tropical homology groups are independent of the covering $\{U_\alpha\}$.

In case X has a polyhedral structure one can require the singular chains to be compatible with the polyhedral face structure on X , rather than with its combinatorial structure. Clearly, the homology groups defines by the two complexes are canonically isomorphic. For polyhedral X there are other equivalent ways for constructing tropical homology groups: simplicial, cellular. This is what we are going to consider next.

2.2. Cellular and simplicial tropical homology. We assume X is polyhedral and compact throughout this subsection. The main advantage of dealing with cellular and simplicial chain groups is that they are finitely generated. This will give an effective way to calculate the tropical homology.

Recall that X comes with a subdivision into convex polyhedral domains. We define the cellular chain complex

$$C_q^{cell}(X; \mathcal{F}_p) = \oplus \mathcal{F}_p(\Delta) = \oplus H_q(\Delta, \partial\Delta; \mathcal{F}_p(\Delta)).$$

Here the direct sum is taken over all q -dimensional faces Δ of the subdivision. The homology $H_q(\Delta, \partial\Delta; \mathcal{F}_p(\Delta))$ of the pair with constant coefficients equals $\mathcal{F}_p(\Delta)$ since each q -dimensional face Δ in X is topologically a closed q -disk (recall that X is compact).

Our next step is to define the boundary homomorphism $\partial : C_q^{cell}(X; \mathcal{F}_p) \rightarrow C_{q-1}^{cell}(X; \mathcal{F}_p)$. The ∂ is the composition of the maps

$$(2.2) \quad H_q(\Delta, \partial\Delta; \mathcal{F}_p(\Delta)) \rightarrow H_{q-1}(\partial\Delta; \mathcal{F}_p(\Delta)) \rightarrow H_{q-1}(\partial\Delta, \partial\Delta \cap \text{Sk}_{q-2}(X); \mathcal{F}_p(\Delta)),$$

the isomorphism

$$(2.3) \quad H_{q-1}(\partial\Delta, \partial\Delta \cap \text{Sk}_{q-2}(X); \mathcal{F}_p(\Delta)) \rightarrow \oplus H_{q-1}(\Delta', \partial\Delta'; \mathcal{F}_p(\Delta)),$$

where the direct sum is taken over all $(q-1)$ -dimensional subfaces $\Delta' \prec \Delta$, and

$$(2.4) \quad \oplus H_{q-1}(\Delta', \partial\Delta'; \mathcal{F}_p(\Delta)) \rightarrow \oplus H_{q-1}(\Delta', \partial\Delta'; \mathcal{F}_p(\Delta')).$$

In (2.2) the first homomorphism is the boundary homomorphism of the pair $(\Delta, \partial\Delta)$ and the second one is induced by the inclusion of the pairs $(\Delta, \emptyset) \subset (\Delta, \partial\Delta)$. The isomorphism (2.3) comes from the excision as the quotient space $\partial\Delta/(\partial\Delta \cap \text{Sk}_{q-2}(X))$ is homeomorphic to a bouquet of $(q-1)$ -dimensional spheres, one sphere for each $(q-1)$ -dimensional subface $\Delta' \prec \Delta$. Finally, the homomorphism (2.4) is induced by (2.1).

The homology groups of the cellular chain complex $(C_{\bullet}^{\text{cell}}(X; \mathcal{F}_p), \partial)$ are called the cellular tropical homology groups $H_{\bullet}^{\text{cell}}(X; \mathcal{F}_p)$. If one has X covered by the open stars of vertices we have the following identification.

Proposition 2.2. *The cellular tropical homology groups $H_{\bullet}^{\text{cell}}(X; \mathcal{F}_p)$ are canonically isomorphic to the (singular) tropical homology groups $H_{\bullet}(X; \mathcal{F}_p)$.*

Proof. As in algebraic topology with constant coefficients to prove this isomorphism we need to use cellular homotopy. Let us recall that by the cellular homotopy argument the inclusion $\text{Sk}_q(X) \rightarrow X$ induces an epimorphism

$$(2.5) \quad H_j(\text{Sk}_q(X); \mathcal{F}_p) \rightarrow H_j(X; \mathcal{F}_p)$$

for $j \leq q$ (which is an isomorphism for $j < q$). Note that even though \mathcal{F}_p is not a constant coefficient system, all cellular homotopy takes place within a single cell, so the classical argument also holds here.

Consider the homomorphism (in singular homology groups) induced by the inclusion of pairs $(\text{Sk}_q(X), \emptyset) \subset (\text{Sk}(X), \text{Sk}_{q-1}(X))$

$$H_q(X; \mathcal{F}_p) \rightarrow H_q(\text{Sk}_q(X), \text{Sk}_{q-1}(X); \mathcal{F}_p) = C_q^{\text{cell}}(X; \mathcal{F}_p).$$

Its image consists of cycles by the construction of the boundary map in the short exact sequence of the pair and thus it gives us a homomorphism

$$(2.6) \quad H_q(\text{Sk}_q(X); \mathcal{F}_p) \rightarrow H_q^{\text{cell}}(X; \mathcal{F}_p).$$

Note that by cellular homotopy the kernel of (2.6) coincides with the kernel of (2.5) for $j = q$. To see surjectivity of (2.6) we consider an element $c \in H_q^{\text{cell}}(X; \mathcal{F}_p)$. Subdividing the faces of X into simplices if needed we may represent c by a singular chain in $C_{\bullet}(\text{Sk}_q(X); \mathcal{F}_p)$, whose boundary ∂c is null-homologous in

$$C_{q-1}^{\text{cell}}(\text{Sk}_{q-1}(X), \text{Sk}_{q-2}(X); \mathcal{F}_p).$$

But $H_{q-1}(\text{Sk}_{q-2}(X); \mathcal{F}_p) = 0$ by the dimensional reason and thus ∂c must also vanish in $H_{q-1}^{\text{cell}}(\text{Sk}_{q-1}(X); \mathcal{F}_p)$. Thus we may correct c (by adding to it a singular chain in $\text{Sk}_{q-1}(X)$ whose boundary coincides with ∂c) to make it a cycle in $C_{\bullet}(X; \mathcal{F}_p)$. \square

Next observation will be very useful when we define the cap product action by the wave class.

Lemma 2.3. *Let $\gamma = \sum \beta_\Delta \Delta$ be a cellular cycle in a compact tropical polyhedral space X . Then each β_Δ is divisible by the divisorial vectors of Δ .*

Proof. We only have to check this for infinite cells Δ . Since X is compact, Δ must have a boundary face Δ_q (of sedentarity one higher) for every divisorial direction q . But the coefficient of $\partial\gamma$ at Δ_q comes only from the projection of β_Δ along q . \square

There is a simplicial variant of the tropical homology arising from the first barycentric simplicial chains on X . (The barycentric subdivision of X was described at the end of Section 1.4). Then we can consider the barycentric simplicial chain complex with coefficients in \mathcal{F}_p as a subcomplex $C_\bullet^{bar}(X; \mathcal{F}_p)$ of $C_\bullet(X; \mathcal{F}_p)$.

Note that the cellular chain complex $C_\bullet^{cell}(X; \mathcal{F}_p)$ can be viewed as a subcomplex of $C_\bullet^{bar}(X; \mathcal{F}_p)$, where all coefficients on simplices of the same cell are taken equal. Applying the standard chain homotopy arguments for constant coefficients one can show that this inclusion

$$C_\bullet^{cell}(X; \mathcal{F}_p) \hookrightarrow C_\bullet^{bar}(X; \mathcal{F}_p)$$

is again a quasi-isomorphism. This allows us to identify both barycentric simplicial and cellular homology with the tropical homology.

Remark 2.4. In [IKMZ12] it is shown that in the case when X is a smooth projective tropical manifold that comes as the limit of a complex 1-parametric family the groups $H_{p,q}(X)$ can be obtained from the limiting mixed Hodge structure of the approximating family. In particular, we have the equality

$$h^{p,q}(X_t) = \text{rk } H_{p,q}(X),$$

for the Hodge numbers $h^{p,q}(X_t)$ of a generic fiber X_t from the approximating family.

Remark 2.5. In Section 7 we will show that there is a fairly small subcomplex of $C_\bullet^{bar}(X; \mathcal{F}_p)$, called konstruktor, which suffices to calculate the homology groups $H_{p,q}(X)$ in the smooth projective realizable case.

2.3. Tropical cohomology groups. Finally we define tropical *cochains* $C^\bullet(X; \mathcal{F}^p)$ to be certain linear functionals on charts/strata compatible \mathbb{Z} -singular chains with values in $\bigoplus_{\alpha, \mathcal{E}} \mathcal{F}^p(\mathcal{E} \cap U_\alpha)$. Namely, if a simplex σ lies in $\mathcal{E} \cap U_\alpha$ then we require the value of the cochain to lie in $\mathcal{F}^p(\mathcal{E} \cap U_\alpha)$. If σ also lies in U_β , then its value in $\mathcal{F}^p(\mathcal{E} \cap U_\beta)$ should coincide with its value in $\mathcal{F}^p(\mathcal{E} \cap U_\alpha)$ via the differential of the overlapping map.

Then one can define the differential as the usual coboundary followed by the maps dual to (2.1)

$$\delta\alpha(\sigma) = \alpha(\partial\sigma) \in \bigoplus_{\tau \subset \sigma} \mathcal{F}^p(\Delta_\tau) \rightarrow \mathcal{F}^p(\Delta_\sigma).$$

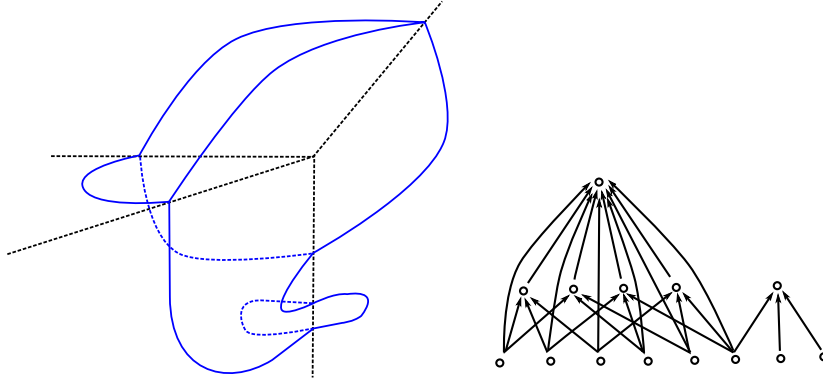

FIGURE 3. An open set in a polyhedral complex and the corresponding quiver. Here $\mathcal{F}_1(U) \cong \mathbb{Z}^4$.

We can define the *tropical cohomology* groups

$$H^{p,q}(X) = H^q(C^\bullet(X; \mathcal{F}^p), \delta).$$

2.4. Sheaf/cosheaf (co)homology. To make connections with sheaf (co)homology theories we use the coefficient systems \mathcal{F}_p to define a constructible cosheaf with respect to the combinatorial stratification of X . With a slight abuse of notations we denote this cosheaf also by \mathcal{F}_p . A cosheaf is a suitable notion to take homology, just like sheaf for cohomology.

First we construct the pre-cosheaf in each open chart U_α . Given an open set $U \subset U_\alpha$ we consider the poset formed by the connected components of intersections of the strata of U_α with U . The order is given by adjacency. This poset can be represented by a quiver (oriented graph) $\Gamma(U)$. Each vertex $v \in \Gamma(U)$ corresponds to a connected component of the intersection $U \cap \mathcal{E}$ of the open set U and a stratum \mathcal{E} of U_α . A single stratum can produce several vertices in $\Gamma(U)$, see Figure 3.

To each vertex v we associate the coefficient group $\mathcal{F}_p(v) = \mathcal{F}_p(\mathcal{E})$. To an arrow from v to w we associate the relevant homomorphism $i_{vw} : \mathcal{F}_p(v) \rightarrow \mathcal{F}_p(w)$ from (2.1). The groups $\mathcal{F}_p(v)$ with maps i_{vw} thus form a representation of the quiver $\Gamma(U)$.

Definition 2.6. $\mathcal{F}_p(U)$ is the quotient of the direct sum $\bigoplus_{v \in \Gamma(U)} \mathcal{F}_p(v)$ by the subgroup generated by the elements $a - i_{vw}(a)$ for all pairs of connected vertices (v, w) , and all $a \in \mathcal{F}_p(v)$.

Note that an inclusion $U \subset V \subset U_\alpha$ induces a morphism between the corresponding quivers $\Gamma(U) \rightarrow \Gamma(V)$ with isomorphisms at the corresponding vertices. This map clearly preserves the equivalence relation, and hence descends to the map $\mathcal{F}_p(U) \rightarrow \mathcal{F}_p(V)$. Thus, we get a covariant functor from the open sets $U \subset U_\alpha$ (with morphism given by inclusions) to free abelian groups $U \mapsto \mathcal{F}_p(U)$. It is easy to check

that all sequences

$$(2.7) \quad \bigoplus_{i,j} \mathcal{F}_p(U_i \cap U_j) \rightarrow \bigoplus_i \mathcal{F}_p(U_i) \rightarrow \mathcal{F}_p(U) \rightarrow 0,$$

where $U = \bigcup U_i$, are exact. Thus the functor $U \mapsto \mathcal{F}_p(U)$ is a cosheaf (cf., e.g. [Br97]) on the open set U_α .

To define the sheaf \mathcal{F}^p we need a contravariant functor $U \mapsto \mathcal{F}^p(U)$. Let $\Gamma(U)$ to be the directed graph as before with all arrows reversed. We set $\mathcal{F}^p(U)$ to be the subgroups of $\bigoplus_{v \in \Gamma(U)} \mathcal{F}^p(v)$, where the collections of elements $\{a_v \in \mathcal{F}^p(v)\}$ are compatible with all the morphisms dual to (2.1). Note that these collections are precisely the ones annihilated by the elements $a - i_{vw}(a)$ from the Definition 2.6, and thus $\mathcal{F}^p(U) = \text{Hom}(\mathcal{F}_p(U), \mathbb{Z})$. Dualizing the exact sequences (2.7) we see that the functor $U \mapsto \mathcal{F}^p(U)$ is a (constructible) sheaf on U_α .

Finally we can glue together the sheaves and cosheaves defined on all open charts U_α (see, e.g., [Ha77], Ch. II, Exer. 1.22, for the sheaf version). We get a well defined cosheaf \mathcal{F}_k and sheaf \mathcal{F}^k on X as long as we have the isomorphisms $\psi_{\alpha\beta}$ between the charts which satisfy $\psi_{\alpha\beta} \circ \psi_{\beta\gamma} = \psi_{\alpha\gamma}$ (see Proposition 1.8).

The combinatorial strata of X form a category. Its objects are the strata themselves. There is a unique morphism from \mathcal{E} to \mathcal{E}' if $\mathcal{E} \prec \mathcal{E}'$, and no morphisms otherwise. Our reasoning above can be formalized into the following general statement.

Proposition 2.7. *Suppose X has an open covering $\{U_\alpha\}$ and covariant functors \mathcal{F}_α for each U_α from the combinatorial strata of U_α to abelian groups which are compatible on the overlaps in the sense of Proposition 1.8. Then gluing gives rise to a constructible sheaf on X . Contravariant functors yields a constructible cosheaf on X .*

If the functors \mathcal{F}_α behave naturally with respect to refinements of the covering $\{U_\alpha\}$ the resulting (co)sheaf \mathcal{F} does not depend on the covering.

Finally we can use the sheaf-theoretic or Čech homology and cohomology for cosheaves \mathcal{F}_p and sheaves \mathcal{F}^p . The standard algebraic topology techniques identify all these homology theories with the tropical (co)homology.

Proposition 2.8. *There are natural isomorphisms*

$$H_{p,q} \cong H_q(X, \mathcal{F}_p) \quad \text{and} \quad H^{p,q} \cong H^q(X, \mathcal{F}^p),$$

where on the right hand side are the sheaf-theoretic (co)homology groups.

3. TROPICAL WAVES

3.1. Waves and cowaves. There is also another collection of sheaves and cosheaves that can be associated to a tropical space X . Recall that for every point $x \in X$ we defined the wave tangent spaces $W(x)$ in Section 1.3.

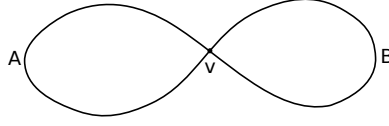

FIGURE 4. Nodal genus 2 curve.

Definition 3.1. We define $W_k(x)$ as the exterior power $\Lambda^k W(x)$. We also consider the dual vector space $W^k(x)$.

In any given chart U_α the $W(x)$ can be canonically identified for points in a single stratum \mathcal{E} . Thus we may write $W_k(\mathcal{E} \cap U_\alpha) = W_k(x)$ for any point $x \in \mathcal{E} \cap U_\alpha$. For a pair $\mathcal{E} \prec \mathcal{E}'$ of two adjacent strata the map (1.4) induces the natural homomorphisms

$$(3.1) \quad \pi : W_k(\mathcal{E}) \rightarrow W_k(\mathcal{E}') \quad \text{and} \quad \hat{\pi} : W^k(\mathcal{E}') \rightarrow W^k(\mathcal{E}).$$

By Proposition 2.7 the coefficient system W_k defines a constructible sheaf \mathcal{W}_k on X , whereas the W^k defines a cosheaf \mathcal{W}^k for every integer $k \geq 0$.

Definition 3.2. Tropical *wave* and *cowave* groups, respectively, are

$$(3.2) \quad H^q(X; \mathcal{W}_k) \quad \text{and} \quad H_q(X; \mathcal{W}^k).$$

Again, we can think of these groups from the sheaf-theoretic point of view or as stratum-compatible singular (co)homology with coefficients in the systems W_k and W^k .

Example 3.3. Let us consider a tropical genus 2 curve C with a simple double point. The underlying topological space of C is a wedge of two circle, i.e. it is a graph with a single vertex v and two edges that are glued to v , see Figure 4.

The tropical structure in the interior of each edge is isomorphic to an open interval of finite length in \mathbb{R} (treated as the tropical torus $\mathbb{T}^\times = \mathbb{T} \setminus \{-\infty\}$). The tropical structure at the vertex v is such that the four primitive vectors divide into 2 pairs of opposite vectors. This means that the chart at v is given by a map to \mathbb{R}^2 such that a neighborhood of v in C goes to the union of coordinate axes and the four primitive vectors near v go to the unit tangent vectors to those axes.

Thus, $\mathcal{F}_1(v) = \mathbb{Z}^2$ and $W_1(v) = 0$. On the other hand every point x in the interior of either edge has the groups $\mathcal{F}_1(x) = \mathbb{Z}$ and $W_1(x) = \mathbb{R}$. The group $\mathcal{F}_0(x)$ is always \mathbb{Z} and $W_0(x) = \mathbb{R}$ for any point x . From the two term cell complex one can easily calculate

$$H_0(C; \mathcal{F}_0) \cong \mathbb{Z}, \quad H_0(C; \mathcal{F}_1) \cong \mathbb{Z}, \quad H_1(C; \mathcal{F}_0) \cong \mathbb{Z}^2, \quad H_1(C; \mathcal{F}_1) \cong \mathbb{Z},$$

and

$$H^0(C; \mathcal{W}_0) \cong \mathbb{R}, \quad H^0(C; \mathcal{W}_1) = 0, \quad H^1(C; \mathcal{W}_0) \cong \mathbb{R}^2, \quad H^1(C; \mathcal{W}_1) \cong \mathbb{R}^2.$$

In general, \mathcal{F}_0 and \mathcal{W}_0 are constants, thus for $p = 0$ we recover the ordinary topological homology and cohomology groups.

Proposition 3.4. *We have $H_{0,q} = H_q(X; \mathbb{Z})$, $H_q(X; \mathcal{W}^0) = H_q(X; \mathbb{R})$, $H^{0,q} = H^q(X; \mathbb{Z})$, $H^q(X; \mathcal{W}_0) = H^q(X; \mathbb{R})$.*

3.2. Pairing of \mathcal{F} and \mathcal{W} . The importance of the wave classes stems from their action on the tropical homology via a natural bilinear map

$$\cap : H^r(X; \mathcal{W}_k) \otimes H_q(X; \mathcal{F}_p \otimes \mathbb{R}) \rightarrow H_{q-r}(X; \mathcal{F}_{p+k} \otimes \mathbb{R})$$

which we are going to define now. On the chain level this map is just the standard cap product between singular chains and cochains coupled with the wedge product on the coefficients $\wedge : W_k \otimes \mathcal{F}_p \rightarrow \mathcal{F}_{p+k} \otimes \mathbb{R}$.

Let us clarify the meaning of the wedge multiplication. For a mobile point $x \in X$ the wave tangent space $W(x)$ is naturally a subspace in $T(x)$ hence the product makes sense on the nose. For any sedentary point x the wave space $W(x)$ naturally projects (along the divisorial directions) to $W'(x)$, which is a subspace of $T(x)$. When taking the wedge product we first apply this projection.

In details, let α be a compatible r -cochain with coefficients in W_k and $\gamma = \sum \beta \sigma$ be a tropical q -chain with coefficients in \mathcal{F}_p . For each singular simplex σ we denote by $\sigma_{0\dots r}$ its first r -face (spanned by the first $r+1$ vertices of σ) and by $\sigma_{r\dots q}$ its last $(q-r)$ -face. Then we set

$$(3.3) \quad \alpha \cap \gamma = \sum (\alpha(\sigma_{0\dots r}) \wedge \beta) \sigma_{r\dots q}.$$

Here we push the value of α at the face $\sigma_{0\dots r}$ to the simplex σ with the sheaf map and then push the value of the result from σ to $\sigma_{r\dots q}$ using the cosheaf map.

We will need the following local observation. Let us assume we live in a single chart U_α .

Lemma 3.5. *Let $\mathcal{E}' \prec \mathcal{E}$ be a pair of adjacent strata in U_α . Then the diagram*

$$\begin{array}{ccc} W_k(\mathcal{E}) \otimes \mathcal{F}_p(\mathcal{E}) & \xrightarrow{\wedge} & \mathcal{F}_{p+k}(\mathcal{E}) \otimes \mathbb{R} \\ \pi \uparrow & & \downarrow \iota \\ W_k(\mathcal{E}') \otimes \mathcal{F}_p(\mathcal{E}') & \xrightarrow{\wedge} & \mathcal{F}_{p+k}(\mathcal{E}') \otimes \mathbb{R} \end{array}$$

is commutative in the sense that for any $\alpha \in W_k(\mathcal{E}')$ and $\beta \in \mathcal{F}_p(\mathcal{E})$ one has $\iota(\pi(\alpha) \wedge \beta) = \alpha \wedge \iota(\beta)$.

Proof. The wedge product is bilinear with respect to inclusion and quotient (in fact, all) homomorphisms between free abelian groups. \square

Proposition 3.6. *For each $r \leq q$ the cap product (3.3) descends to a natural bilinear map in homology*

$$\cap : H^r(X; \mathcal{W}_k) \otimes H_q(X; \mathcal{F}_p \otimes \mathbb{R}) \rightarrow H_{q-r}(X; \mathcal{F}_{p+k} \otimes \mathbb{R}).$$

Proof. The statement follows at once from the usual Leibnitz formula

$$(-1)^r \partial(\alpha \cap \gamma) = (\delta\alpha) \cap \gamma + \alpha \cap \partial\gamma.$$

Note that the wedge products in $\delta(\alpha \cap \gamma)$ and $(\partial\alpha) \cap \gamma$ are taken in σ and then pushed to $\mathcal{F}_{p+k}(\sigma_{r \dots \hat{i} \dots q})$. On the other hand the wedge products in $\alpha \cap \delta\gamma$ are taken in $\sigma_{0 \dots \hat{i} \dots q}$ and then pushed to $\mathcal{F}_{p+k}(\sigma_{r \dots \hat{i} \dots q})$. But Lemma 3.5 allows us to identify the results. \square

3.3. The group $H^1(X; \mathcal{W}_1 \otimes \mathbb{R})$ and deformations of the tropical structure of X . In this section we assume that X is compact. Recall that X has a covering by charts $\phi_\alpha : U_\alpha \rightarrow Y_\alpha \subset \mathbb{T}^{N_\alpha}$. The transition maps on the overlaps are given by integral affine maps $\psi_{\alpha\beta} : \mathbb{T}^{N_\alpha} \dashrightarrow \mathbb{T}^{N_\beta}$.

As a topological space X can be presented as the quotient of the disjoint union of its covering sets $\bigsqcup_\alpha (U_\alpha)$ by the following equivalence relation. We say two points $x \in U_\alpha$ and $y \in U_\beta$ are equivalent if $\psi_{\alpha\beta} \circ \phi_\alpha(x) = \phi_\beta(y)$. Reflexivity of equivalence says that $\psi_{\alpha\beta} = \psi_{\beta\alpha}^{-1}$ (as partially defined maps). Transitivity translates as the cocycle condition, or as the composition rule, $\psi_{\beta\gamma} \circ \psi_{\alpha\beta} = \psi_{\alpha\gamma}$.

Conversely, given open subsets $\phi_\alpha(U_\alpha) \subset Y_\alpha \subset \mathbb{T}^{N_\alpha}$ and a collection of integral affine maps $\psi_{\alpha\beta}$ satisfying $\psi_{\alpha\beta} = \psi_{\beta\alpha}^{-1}$ and $\psi_{\beta\gamma} \circ \psi_{\alpha\beta} = \psi_{\alpha\gamma}$ we can define a topological space X as the quotient of $\bigsqcup_\alpha \phi_\alpha(U_\alpha)$ by the equivalence given by the ψ 's.

X will be a tropical space provided all subsets $\phi_\alpha(U_\alpha)$ remain open in the quotient and X satisfies the finite type condition. Moreover we will get an isomorphic tropical space if the $\psi_{\alpha\beta}$ are changed by a "coboundary" (twisted by automorphisms $\psi_\alpha : \mathbb{T}^{N_\alpha} \dashrightarrow \mathbb{T}^{N_\alpha}$ for some α).

Let τ be a class in $H^1(X; \mathcal{W}_1)$. We can assume that the covering $\{U_\alpha\}$ is fine enough so that τ can be represented by a Čech 1-cocycle $\tau_{\alpha\beta} \in W(U_\alpha \cap U_\beta)$. We can also assume that all U_α and $U_\alpha \cap U_\beta$ are connected. Then $W(U_\alpha \cap U_\beta)$ consists of vectors parallel to all mobile strata in $U_\alpha \cap U_\beta$. We can think of $W(U_\alpha \cap U_\beta)$ as a subspace in $\mathbb{R}^{N_\alpha} \subset \mathbb{T}^{N_\alpha}$ via the map ϕ_α , or in $\mathbb{R}^{N_\beta} \subset \mathbb{T}^{N_\beta}$ via ϕ_β .

By shrinking the U_α if necessary it will also be convenient to assume that slightly larger open subsets $V_\alpha \supset \overline{U_\alpha}$ do not contain any new strata other than those already in the U_α . For instance if X is polyhedral we can take U_α to be the open stars of vertices, "shrunk" a little bit.

Now for $\epsilon > 0$ we modify the overlapping maps $\psi_{\alpha\beta} : \mathbb{T}^{N_\alpha} \dashrightarrow \mathbb{T}^{N_\beta}$ by precomposing them with the translation by $\epsilon\tau_{\alpha\beta}$. Since $\tau_{\alpha\beta} = -\tau_{\beta\alpha}$ the new relation is reflexive. Also since τ is a cocycle the new maps $\psi_{\alpha\beta}^{\epsilon\tau}$ satisfy the composition rule. Thus they define a new equivalence relation and we call the corresponding quotient space $X_{\epsilon\tau}$ the deformation of X .

Proposition 3.7. *For $\epsilon > 0$, small enough, $X_{\epsilon\tau}$ is a tropical space.*

Proof. We only need to show that $X_{\epsilon\tau}$ is of finite type and each of the U_α is still an open subset in $X_{\epsilon\tau}$. For the latter it is enough to show that each $U_\alpha \cap U_\beta$ is open.

But this is clear since by condition that slight enlargements of U_α contain no new strata, no new strata can appear in $U_\alpha \cap U_\beta$ for small enough ϵ . The argument for the finite type condition is similar. \square

The deformed tropical space is especially easy to visualize in the polyhedral case. Namely, $X_{\epsilon\tau}$ has the same combinatorial face structure, but the faces of $X_{\epsilon\alpha}$ themselves may have different shapes and sizes. E.g. if X is 1-dimensional, the lengths of the edges of X and $X_{\epsilon\alpha}$ may be different.

4. STRAIGHT CLASSES

4.1. Straight cycles in tropical homology. We start with a natural generalization of balanced polyhedral complexes in \mathbb{T}^N to a situation where a facet can have a weight. A weighted balanced polyhedral complex $Y \subset \mathbb{T}^N$ is a union of a finite number of facets D as before, but now each D is enhanced with an integer weight $w(D) \in \mathbb{Z}$ subject to the following weighted balancing condition for every $(n-1)$ -dimensional mobile face $E \subset Y$. As in (1.3) we consider all facets $D_1, \dots, D_l \subset \mathbb{T}^N$ adjacent to E and take the quotient of \mathbb{R}^N by the linear subspace parallel to E° , the non-infinite part of E . The weighted balanced condition is

$$(4.1) \quad \sum_{k=1}^l w(D_k) \epsilon_k = 0.$$

We say that the weighted balanced complex Y is *effective* if the weights of all its facets are positive.

Just as balanced polyhedral complexes form local models for tropical spaces, effective weighted balanced polyhedral complexes form models for *weighted tropical spaces*.

Definition 4.1. A weighted tropical space is a topological space X enhanced with a weight function $w : X \dashrightarrow \mathbb{N}$ defined on an open dense set $A \subset X$ and a sheaf \mathcal{O}_X of functions to \mathbb{T} such that there exists a finite covering of compatible charts $\phi_\alpha : U_\alpha \rightarrow Y_\alpha \subset \mathbb{T}^{N_\alpha}$ with the following properties.

- Y_α is an effective weighted balanced polyhedral complex in \mathbb{T}^{N_α} .
- For the relative interior D° of any facet $D \subset Y_\alpha$ we have $\phi_\alpha^{-1}(D^\circ) \subset A$ while the weight function w is constant on $\phi_\alpha^{-1}(D^\circ)$ and equal to the weight of D .
- For each facet $D \subset Y_\alpha$ there exists a \mathbb{Z} -linear transformation $\Phi_D : \mathbb{Z}^{N_\alpha} \rightarrow \mathbb{Z}^{N_\alpha}$ of determinant $w(D)$ such that $\mathcal{O}_X|_{D^\circ \cap U_\alpha}$ is induced by $\Phi_D^{-1} \circ \phi_\alpha$.

We may reformulate the last condition of this definition by saying that each facet D comes with a sublattice of index $w(D)$ of the tangent lattice $T_{\mathbb{Z}}(x)$, $x \in D$. This sublattice is locally constant and does not depend on the choice of charts. Note that not every weighted balanced polyhedral complex in \mathbb{T}^N is a weighted tropical space in this sense as it is not always possible to consistently choose such a sublattice. However no such sublattice for the facets of Z is needed for the following definition.

Definition 4.2 (cf. [MR12], [Sh12]). Let X be a tropical space. A subspace $Z \subset X$ enhanced with a weight function

$$w : Z \dashrightarrow \mathbb{Z}$$

defined on an open dense set $A \subset Z$ is called a *straight tropical p -cycle* if for every chart $\phi_\alpha : U_\alpha \rightarrow Y_\alpha \subset \mathbb{T}^{N_\alpha}$ of X there exists a weighted p -dimensional balanced polyhedral complex $Z_\alpha \subset \mathbb{T}^{N_\alpha}$ such that $\phi_\alpha : Z \cap U_\alpha \rightarrow Z_\alpha$ is an open embedding, and for the relative interior D° of any facet $D \subset Z_\alpha$ we have $\phi_\alpha^{-1}(D^\circ) \subset A$. The weight function w is constant on $\phi_\alpha^{-1}(D^\circ)$ and equal to the weight of D .

Proposition 4.3. *Each straight tropical p -cycle $Z \subset X$ gives rise to a canonical element $[Z] \in H_{p,p}(X)$ in the tropical homology group of X .*

Proof. We choose a sufficiently fine (topological) triangulation of $Z = \bigcup \sigma$ so that each p -simplex σ from the triangulation lies in a single chart U_α and in a single combinatorial stratum \mathcal{E} of X . In particular each σ carries the weight $w(\sigma)$ induced from Z . An orientation of σ defines the canonical volume element $\text{Vol}_\sigma \in \mathcal{F}_p^X(\sigma)$ given by the generator of $\Lambda^p(W_\mathbb{Z}^Z(\sigma)) \cong \mathbb{Z}$. Inverting the orientation of σ will simultaneously invert the sign of Vol_σ . Thus the product $\text{Vol}_\sigma \sigma$ is a well-defined tropical chain in $C_p(X; \mathcal{F}_p)$. Then the weighted balancing condition for Z ensures that

$$\gamma_Z = \sum_{\sigma \subset Z} w(\sigma) \text{Vol}_\sigma \sigma$$

is a cycle in $C_p(X; \mathcal{F}_p)$. Its class is clearly independent of the triangulation and gives the desired element $[Z] \in H_p(X; \mathcal{F}_p) = H_{p,p}(X)$. \square

Definition 4.4. Elements of $H_{p,p}$ realised by straight tropical cycles as in Proposition 4.3 are called straight homology classes (or, in other existing terminology, *special* or *algebraic*). They form a subgroup

$$H_{p,p}^{\text{straight}}(X) \subset H_{p,p}(X).$$

Example 4.5. Recall that the tropical N -dimensional projective space \mathbb{TP}^N may be obtained by gluing $N + 1$ affine charts \mathbb{T}^N with the help of integral affine maps, cf. e.g. [MR12]. A topological subspace $X \subset \mathbb{TP}^N$ is called a *projective tropical space* if the intersection of X with any such chart is a balanced polyhedral complex. A projective tropical space has a non-trivial straight homology class

$$[H_p^X] \in H_{p,p}^{\text{straight}}(X)$$

(called the *hyperplane section*) in any dimension $p = 0, \dots, n = \dim X$.

To see this we start from the case $X = \mathbb{TP}^N$. Consider the equations $x_j = c_j$, $j = p + 1, \dots, n$, $c_j \in \mathbb{R}$, in a chart $\mathbb{T}^N \subset \mathbb{TP}^N$. They define a p -dimensional linear space parallel to a coordinate plane. We may take for H_p the topological closure of this linear space in \mathbb{TP}^N . Clearly, the homology class $[H_p]$ does not depend on the choice of the \mathbb{T}^N -chart or on permutation of coordinates in this chart. Furthermore,

H_0 is a point and thus $[H_0] \neq 0$ in $H_{0,0}(\mathbb{TP}^N) \cong \mathbb{Z}$. Note that this also implies that $[H_p] \neq 0$ in $H_{p,p}(\mathbb{TP}^N)$ as we may choose the transverse representatives H_p and $H_{p'}$ so that $H_p \cap H_{p'} = H_{p+p'-N}$, cf. [Sh12]. It is easy to show that any element of $H_{*,*}(\mathbb{TP}^N)$ is generated by $[H_p]$, $p = 0, \dots, N$.

A similar construction can be made for general projective tropical spaces $X \subset \mathbb{TP}^N$. We take $H_p^X = H_{N+p-n} \cap X$ where H_{N+p-n} is chosen to be transverse to X with the help of translations in \mathbb{R}^N . But in addition to those hyperplane sections and their powers $H_{*,*}(X)$ may have additional, more interesting, straight classes.

4.2. Straight cowaves. A notion of straight classes exists also for cowaves. Once again, let $Z \subset X$ be a subspace such that each chart ϕ_α takes Z to a q -dimensional polyhedral complex in \mathbb{T}^{N_α} (which we no longer assume balanced). We refer to such subspace of X as a *straight subspace*.

In this subsection we assume that $\dim W(x) = m$ for some m almost everywhere on Z . In other words we assume that each open facet of Z sits in the m -skeleton of X , but outside of the $(m-1)$ -skeleton of X . We call such straight subspaces Z *purely m -skeletal*. E.g. Z is n -skeletal if no open facets of Z intersect $\text{Sk}_{n-1}(X)$.

Definition 4.6. A *coweight function* on Z is a function

$$x \mapsto \text{cow}(x) \in W^m(x)$$

defined on an open dense set $A \subset Z$. Here we assume that $\dim W(x) = m$ whenever $x \in A$, so we have $W^m(x) \approx \mathbb{Z}$.

This is a dual notion to the weight function. But while the weight function was integer-valued, here we do not have a canonical isomorphism between $W^m(x)$ and \mathbb{Z} , it is only canonical up to sign.

Let $x \in A$ be inside of a facet of Z parallel to a q -dimensional affine space L (in a chart ϕ_α). As in the previous subsection, we may consider the volume element $\text{Vol}_L \in W_q(x)$ which is well-defined by the integer lattice in L and a choice of orientation of L . Given this choice we have a well-defined map

$$\lambda \mapsto \text{cow}(x)(\lambda \wedge \text{Vol}_L),$$

$\lambda \in W_{m-q}(x)$ and thus an element in $W^{m-q}(x)$, a group that depends only on the open facet of Z containing x . Thus any q -simplex σ embedded to the same facet and parallel to L defines a canonical chain with coefficients in $W^{m-q}(x)$.

In particular, a triangulation of a coweighted purely m -skeletal q -dimensional polyhedral pseudocomplex Y gives rise to a cowave chain in $C_q(X; \mathcal{W}^{m-q})$. Such cowave chains are called *straight*.

As in Proposition 4.3 we may associate a singular chain with the coefficients in W^{m-q} to Z by using a combinatorial stratification of Z .

Definition 4.7. A coweighted straight subspace $Z \subset X$ is called *cobalanced* if the resulting chain is a cycle. We may refine this into a local notion by saying that

Z is cobalanced at $x \in Z$ if x is disjoint from the support of the boundary of the resulting special cowave cochain.

Note that once an orientation of $W(x)$ is chosen we may identify coweight and weight at x .

Proposition 4.8. *Suppose that a q -dimensional coweighted straight subspace Z is purely m -skeletal and that $x \in Z$ belongs to a relative interior of a $(q-1)$ -dimensional face (in a chart) with $\dim W(x) = m$. Then Z is cobalanced at x if and only if Z is balanced at x .*

Proof. Note that x must belong to the same combinatorial stratum of X as its small open neighbourhood in Z , since Z is purely m -skeletal and $\dim W(x) = m$. Thus $\mathcal{W}^m|_Z$ is locally trivial near x and we may translate coweights into weights simultaneously for the whole neighbourhood with the help of an arbitrary orientation of $W(x)$. \square

At the same time if $\dim W(x) < m$ then the cobalancing condition is different from the balancing condition. We believe that study of straight cowaves might be useful, particularly in the context of mirror symmetry.

5. THE EIGENWAVE

5.1. The eigenwave ϕ . There is a canonical element $\phi \in H^1(X; \mathcal{W}_1)$ for every compact tropical space X . Unfortunately, it does not have a preferred representative as a singular wave cocycle in the case when X has points of positive sedentarity. Rather we shall represent it in the quotient space $C^1(X; \mathcal{W}_1)/B_{div}^1(X; \mathcal{W}_1)$ where the subspace $B_{div}^1(X; \mathcal{W}_1) \subset C^1(X; \mathcal{W}_1)$ will consist of certain coboundaries. Note that this ambiguity will not cause us any problems with the cap product of ϕ and the homology cycles because, as we will see, taking product with elements in $B_{div}^1(X; \mathcal{W}_1)$ annihilates any singular cycle.

Let $C_{div}^0(X; \mathcal{W}_1) \subset C^0(X; \mathcal{W}_1)$ be the subspace of 0-wave cochains whose values on points $x \in X$ are in $W^{div}(x)$. We let $B_{div}^1(X; \mathcal{W}_1) \subset C^1(X; \mathcal{W}_1)$ consist of the coboundaries of the cochains from $C_{div}^0(X; \mathcal{W}_1)$. The elements $\gamma \in B_{div}^1(X; \mathcal{W}_1)$ are characterized by the property that on any singular 1-simplex τ the values $\gamma(\tau)$ belong to the subspace $W^{div}(\tau) \subset W(\tau)$ spanned by the divisorial subspaces at the boundary points of τ .

We are ready to define the eigenwave class $\phi \in C^1(X; \mathcal{W}_1)/B_{div}^1(X; \mathcal{W}_1)$. Let us first consider the case when all points of X have zero sedentarity, in particular $B_{div}^1(X; \mathcal{W}_1) = 0$. In such case we define the value of ϕ on a singular 1-simplex $\tau : [0, 1] \rightarrow X$ as $\tau(1) - \tau(0)$. Recall that our singular chains are assumed to be compatible with the combinatorial stratification of X so that $\tau((0, 1))$ is contained in a single combinatorial stratum and a single tropical chart. This means that the difference $\tau(1) - \tau(0)$ can be interpreted as a vector in the tangent space to this stratum and therefore in $W(\tau)$.

Returning to the general case, if $x \in X$ is of positive sedentarity we choose a nearby mobile point y_x which maps to x under the projection along divisorial directions. If $x \in X$ is mobile we set $y_x = x$.

Definition 5.1. The element $\phi \in C^1(X; \mathcal{W}_1)/B_{div}^1(X; \mathcal{W}_1)$ is defined on a 1-simplex $\tau : [0, 1] \rightarrow X$ as the vector $w_\tau := y_{\tau(1)} - y_{\tau(0)} \in W(\tau)$.

Clearly the ambiguity in w_τ resulting from different choices of y_x is confined to $B_{div}^1(X; \mathcal{W}_1)$. The next proposition asserts that ϕ defines a class in $H^1(X; \mathcal{W}_1)$, which we call the *eigenwave* of X . We denote this class also by ϕ , this should not cause any confusion.

Proposition 5.2. $\delta\phi = 0$.

Proof. By definition the value of $\delta\phi$ on a 2-simplex σ is the sum of the values of ϕ on the three edges τ_1, τ_2, τ_3 of σ . This is clearly zero (perhaps after applying the maps $\pi : W(\tau) \rightarrow W(\sigma)$ in case some of the τ_i land in different strata). \square

5.2. Action of the eigenwave ϕ and its powers on tropical homology. The k -th cup powers of ϕ are also (higher degree) wave classes $\phi^k \in H^k(X; \mathcal{W}_k)$. One can define the value of ϕ^k on a k -simplex σ modulo the ideal in $W_k(\sigma)$ generated by the W^{div} for all vertices in σ . Namely, for an edge $\tau \prec \sigma$ let $w_\tau \in W(\sigma)$ stand for the vector $y_{\tau(1)} - y_{\tau(0)} \in W(\tau)$ pushed to $W(\sigma)$. Then

$$(5.1) \quad \phi^k(\sigma) = w_{\sigma_{01}} \wedge \cdots \wedge w_{\sigma_{k-1,k}} =: w_\sigma \in W_k(\sigma).$$

Taking the cap product with $\phi^k = [\phi_{sing}^k]$ gives us the homomorphism:

$$(5.2) \quad \phi^k \cap : H_q(X; \mathcal{F}_p \otimes \mathbb{R}) \rightarrow H_{q-k}(X; \mathcal{F}_{p+k} \otimes \mathbb{R}).$$

In case X is compact and polyhedral we consider its barycentric subdivision and think of the $H_q(X; \mathcal{F}_p)$ as simplicial or cellular homology groups. The advantage is that we can define the cap product with ϕ^k on the cycle level

$$(5.3) \quad \phi^k : C_q^{cell}(\mathcal{F}_p) \rightarrow C_{q-k}^{bar}(\mathcal{F}_{p+k} \otimes \mathbb{R}).$$

Below we give two different descriptions of the map (5.3) depending on the choice of vertex ordering. The first result is a cycle in $C_{q-k}^{bar}(\mathcal{F}_{p+k} \otimes \mathbb{R})$ while the second one is still in $C_{q-k}^{cell}(\mathcal{F}_{p+k} \otimes \mathbb{R}) \subset C_{q-k}^{bar}(\mathcal{F}_{p+k} \otimes \mathbb{R})$.

We recall the notion of the dual cells in the first barycentric subdivision of a polyhedral complex. Let $\Delta \in X$ be a q -cell. For any *finite* j -dimensional face $\Delta' \prec \Delta$ of the sedentarity $s(\Delta') = s(\Delta)$ its *dual cell* $\hat{\Delta}'_\Delta$ in the barycentric subdivision of Δ is defined as the union of all $(q-j)$ -simplices in $bar(\Delta)$ containing the barycenters of Δ and Δ' . We can think of $\hat{\Delta}'_\Delta$ as a simplicial $(q-j)$ -chain. The orientations of the pair Δ' and $\hat{\Delta}'_\Delta$ are taken to agree with the original orientation of Δ .

Let $\gamma = \sum \beta_\Delta \Delta$ be a cycle in $C_q^{cell}(X; \mathcal{F}_p)$. Then according to Lemma 2.3 the coefficients β_Δ for all $\Delta \subset X$ have to be divisible by the divisorial directions of Δ . In

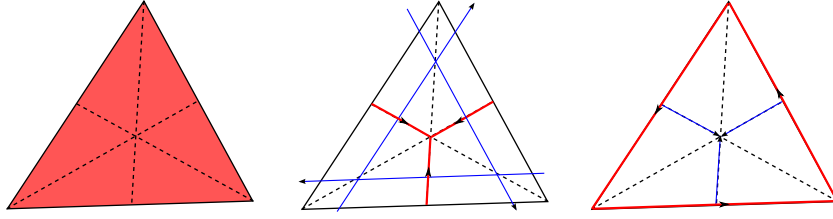

FIGURE 5. The two descriptions of the wave action on a 2-cell σ . The support of $\phi_{sing} \cap \sigma$ is red and the framing is blue.

particular, the wedge product of β_Δ with any element in $\wedge^k(W(\Delta)/W^{div}(\Delta))$ gives a well-defined element in $\mathcal{F}_{p+k}(\Delta) \otimes \mathbb{R}$. We can also think of $\gamma = \sum_{\sigma \in bar(\Delta)} \beta_\Delta \sigma$ as an element in $C_q^{bar}(X; \mathcal{F}_p)$.

Description 1: We label the vertices of each q -simplex σ in $bar(\Delta)$ according to the dimension of the largest cells whose baricenters they represent (recall that several faces of Δ of different sedentarity may have the same baricenter). In this case the cycle $\phi^k \cap \gamma \in C_{q-k}^{bar}(X; \mathcal{F}_{p+k})$ is supported on the dual subdivision inside the q -skeleton of X .

Precisely, for every k -face Δ' of Δ let $w_{\Delta'} \in W_k(\Delta)$ denote the volume element associated to Δ' as in (5.1). Clearly, $w_{\Delta'}$ equals the sum of all $w_{\sigma_{0\dots k}}$ (taken with appropriate signs) for the k -simplices $\sigma_{0\dots k}$ forming the barycentric triangulation of Δ' . Then one can easily calculate from the definition of the cap product:

$$(5.4) \quad \phi^k \cap \left(\sum_{\sigma \in bar(\Delta)} \beta_\Delta \sigma \right) = \sum_{\Delta' \prec \Delta} (w_{\Delta'} \wedge \beta_\Delta) \hat{\Delta}'_{\Delta'},$$

where the sum is taken over all k -dimensional faces of Δ . Note that higher sedentary k -faces don't appear in the sum because β_Δ vanishes when pushed to these higher sedentary faces.

Description 2: Here we label the vertices of each σ in the opposite order to the description 1. That is the baricenters with the smaller numbers correspond to the larger faces. Now the cycle $\phi^k \cap \gamma \in C_{q-k}^{bar}(X; \mathcal{F}_{p+k})$ is supported on the $(q-k)$ -skeleton of X .

Precisely, for every $(q-k)$ -face Δ' of Δ let $\hat{w}_{\Delta'} \in W_k(\Delta)$ denote the polyvector corresponding to the integration along the chain $\hat{\Delta}'_{\Delta'}$. Note that the faces $\sigma_{k\dots q}$ lie in the $(q-k)$ -faces of Δ . The polyvectors $w_{\sigma_{0\dots k}}$ sum to $\hat{w}_{\Delta'}$ for those simplices $\sigma \in bar(\Delta)$ whose faces $\sigma_{k\dots q}$ give the same simplex in $bar(\Delta')$. Then again from the definition of the cap product we can write:

$$(5.5) \quad \phi^k \cap \left(\sum_{\sigma \in bar(\Delta)} \beta_\Delta \sigma \right) = \sum_{\Delta' \prec \Delta} (\hat{w}_{\Delta'} \wedge \beta_\Delta) \Delta',$$

where the sum is taken now over all $(q-k)$ -dimensional faces of Δ .

It is straight forward to check that in both cases the resulting chain

$$\phi^k \cap \left(\sum_{\Delta} \sum_{\sigma \in \text{bar}(\Delta)} \beta_{\Delta} \sigma \right)$$

is a cycle.

Conjecture 5.3. *Let X be a smooth compact tropical variety. Then for $q \geq p$*

$$\phi^{q-p} \cap : H_q(X; \mathcal{F}_p \otimes \mathbb{R}) \rightarrow H_p(X; \mathcal{F}_q \otimes \mathbb{R})$$

is an isomorphism.

We will prove the conjecture in the realizable case in Section 7 though we believe that realizability assumption is not necessary. Certain amount of smoothness, on the other hand, is essential. In the non-smooth case even the ranks of $H_q(X; \mathcal{F}_p)$ and $H_p(X; \mathcal{F}_q)$ may not agree. A simple example is provided by the nodal genus 2 curve (see Example 3.3).

The action of the eigenwave ϕ is trivial on straight tropical (p, p) -classes.

Theorem 5.4. *If $\gamma \in H_{p,p}^{\text{straight}}(X)$ then $\phi \cap \gamma = 0$.*

Proof. Any vector parallel to a simplex σ of a special tropical cycle turns to zero after the wedge product with the volume element of σ . \square

6. INTERMEDIATE JACOBIANS

6.1. Tropical tori. Let V be a g -dimensional real vector space containing two lattices Γ_1, Γ_2 of maximal rank, that is $V \cong \Gamma_{1,2} \otimes \mathbb{R}$. Suppose we are given an isomorphism $Q : \Gamma_1 \rightarrow \Gamma_2^*$, which is symmetric if thought of as a bilinear form on V .

Definition 6.1. The torus $J = V/\Gamma_1$ is the *principally polarized tropical torus* with Q being its polarization. The tropical structure on J is given by the lattice Γ_2 . If, in addition Q is positive definite, we say that J is an *abelian variety*.

Remark 6.2. The map $Q : \Gamma_1 \rightarrow \Gamma_2^*$ provides an isomorphism of $J = V/\Gamma_1$ with the tropical torus V^*/Γ_2^* . The tropical structure on the latter is provided by the lattice Γ_1^* .

Remark 6.3. The above data $(V, \Gamma_1, \Gamma_2, Q)$ is equivalent to a non-degenerate real-valued quadratic form Q on a free abelian group $\Gamma_1 \cong \mathbb{Z}^g$. The other lattice $\Gamma_2 \subset V := \Gamma_1 \otimes \mathbb{R}$ is defined as the dual lattice to the image of Γ_1 under the isomorphism $V \rightarrow (V)^*$ given by Q .

Let us take the free abelian group $\Gamma_1 = H_q(X; \mathcal{F}_p) \cong \mathbb{Z}^g$ with $p + q = \dim X$, and $p \leq q$. We define the tropical intermediate Jacobian as the torus above together with a symmetric bilinear form Q on $H_q(X; \mathcal{F}_p)$.

The form Q is a certain intersection product on tropical cycles which we define in two ways. The first definition is manifestly symmetric while the second definition descends to homology. And then we show that the two definitions are equivalent.

Unfortunately we are not able to show in this paper that the form is non-degenerate, though we believe that in the smooth and compact case this should be true (cf. Conjecture 6.15).

6.2. Intersection product. Let X be a compact tropical space of dimension n . For a singular simplex σ we denote its relative interior by $\text{int}(\sigma)$. We abuse the notation $\text{int}(\sigma)$ to denote also its image in X .

Definition 6.4. We say that a tropical chain $\sum \beta_\sigma \sigma \in C_q(X; \mathcal{F}_p)$ is *transversal to the combinatorial stratification of X* (or, simply, transversal) if for any simplex σ and any face $\tau \prec_k \sigma$ we have

- $\text{int}(\tau)$ meets strata of X only of dimension $(n - k)$ and higher;
- if τ lies in a sedentary stratum of X then β_σ is divisible by all corresponding divisorial directions.

Definition 6.5. We say that two transversal tropical chains $\sum \beta_{\sigma'} \sigma' \in C_{q'}(X; \mathcal{F}_{p'})$ and $\sum \beta_{\sigma''} \sigma'' \in C_{q''}(X; \mathcal{F}_{p''})$ form a *transversal pair* if the following holds. For every pair of simplices σ', σ'' from these chains and any choice of their faces $\tau' \prec \sigma', \tau'' \prec \sigma''$, if the interiors $\text{int}(\tau'), \text{int}(\tau'')$ lie in the same stratum \mathcal{E} then $\text{int}(\tau'), \text{int}(\tau'')$ are transversal in the usual sense as smooth maps to \mathcal{E} .

If a pair of simplices σ', σ'' from the transversal pair have non-empty intersection then all three submanifolds $\sigma', \sigma'', \sigma' \cap \sigma''$ are supported on the same maximal stratum $\mathcal{E}_{\sigma' \cap \sigma''}$ of X (and on no smaller strata). The oriented triple $\sigma', \sigma'', \sigma' \cap \sigma''$ determines an integral volume element $\text{Vol}_{\mathcal{E}_{\sigma' \cap \sigma''}}$ as well as its dual volume form $\Omega_{\mathcal{E}_{\sigma' \cap \sigma''}}$. By transversality, $\sigma' \cap \sigma''$ has dimension $q' + q'' - n$. We can choose a singular chain $\sum \tau$ representing its relative fundamental class agreeing with the orientation of $\sigma' \cap \sigma''$.

Let $\gamma' = \sum \beta_{\sigma'} \sigma' \in C_{q'}(X; \mathcal{F}_{p'})$ and $\gamma'' = \sum \beta_{\sigma''} \sigma'' \in C_{q''}(X; \mathcal{F}_{p''})$ be a transversal pair of tropical chains. We define the following bilinear product with values in the cowave chains:

$$(6.1) \quad \gamma' \cdot \gamma'' = \sum_{\tau \subset \sigma' \cap \sigma''} \Omega_{\mathcal{E}_\tau}(\beta_{\sigma'} \wedge \beta_{\sigma''}) \cdot \tau \in C_{q'+q''-n}(X; \mathcal{W}^{n-p'-p''}).$$

Remark 6.6. Note that $\gamma' \cdot \gamma''$ has no support on infinite simplices $\tau \subset \sigma' \cap \sigma''$ since the divisorial directions in $W^{\text{div}}(\tau)$ divide both $\beta_{\sigma'}$ and $\beta_{\sigma''}$.

Remark 6.7. If $q' + q'' < n$ or $p' + p'' > n$ then $\gamma' \cdot \gamma'' = 0$ for dimensional reasons. In what follows we will tacitly assume this is not the case.

From now on we assume that X is a compact smooth tropical space. Our goal will be to show that in this case the above product descends to homology.

First we show that we can deform all cycles to a transverse position. Since the question is local we can work in a chart $\phi_\alpha : U_\alpha \rightarrow Y \subset \mathbb{T}^N$. The next lemma says that we can move a tropical cycle γ off a face E of Y , if it intersects it in higher than expected dimension, not changing it outside the open star $\text{St}(E)$.

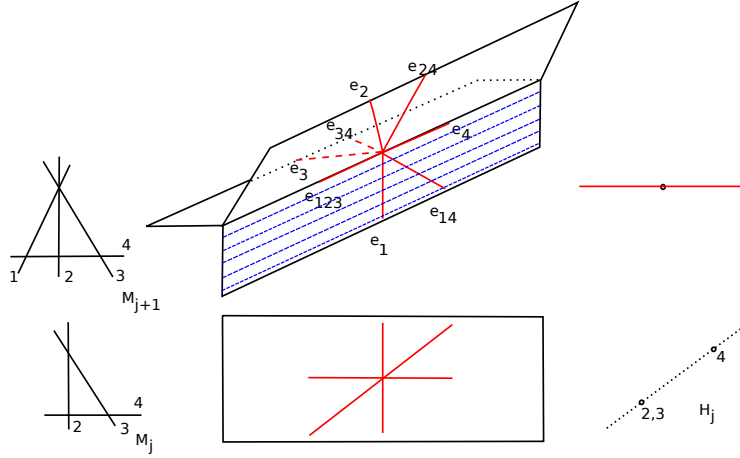

FIGURE 6. The matroids M_{j+1} , M_j and H_j and their corresponding fans. The fan $Y'_{M_{j+1}}$ is the unshaded part of $Y_{M_{j+1}}$. The shaded part of $Y_{M_{j+1}}$ is $\text{St}(e_{\epsilon_{j+1}})$.

Lemma 6.8. *Let $\gamma \in C_q(X, \mathcal{F}_p)$ be a (singular) tropical cycle in a tropical n -dimensional manifold X and let E be an l -face of Y in a chart $\phi_\alpha : U_\alpha \rightarrow Y \subset \mathbb{T}^N$. Then there exists a cycle $\gamma' = \sum \beta_\sigma \sigma \in C_q(X; \mathcal{F}_p)$ homologous to γ and such that for any $(q-k)$ -face τ of a simplex σ we have $\text{int}(\tau) \cap E = \emptyset$, i.e. τ is not supported on E whenever $k+l < n$. In addition, γ' satisfies to the following properties:*

- $\gamma \cap (X \setminus (U_\alpha \cap \text{St}(E))) = \gamma' \cap (X \setminus (U_\alpha \cap \text{St}(E)))$,
- the chain $\gamma - \gamma'$ is the boundary of a tropical $(q+1)$ -chain supported in $U_\alpha \cap \text{St}(E)$,
- if E has positive sedentarity then any simplex σ such that $\sigma \cap E \neq \emptyset$ has its coefficient β_σ divisible by all divisorial vectors corresponding to E .

Proof. First let us consider the case when E is mobile. Working in a chart we can assume Y is the Bergman fan for some loopless matroid M . Clearly, any matroid M contains a uniform submatroid $M_0 \subset M$ of the same rank $r(M)$ (by submatroid we mean a subset with the restriction of the rank function). Thus, we have a sequence $M_0 \subset \dots \subset M_{|M|-r(M)} = M$ of submatroids of M such that M_{j+1} is obtained from M_j by adding one element ϵ_{j+1} . We may form a matroid H_j of rank $r(M_j) - 1$ by setting a new rank function r_{H_j} on M_j , $r_{H_j}(A) = r_M(A \cup \epsilon_{j+1}) - 1$ for $A \subset M_j$.

The fan $Y_{M_{j+1}} \subset \mathbb{R}^{|M_{j+1}|}$ maps to the fan $Y_{M_j} \subset \mathbb{R}^{|M_j|-1}$ by projection along the coordinate corresponding to the element ϵ_{j+1} . If the matroid H_j has loops this map

$$\tau_j : Y_{M_{j+1}} \rightarrow Y_{M_j}$$

is an isomorphism. Otherwise note that the Bergman fan Y_{H_j} is a subfan of Y_{M_j} . Also we denote by $Y'_{M_{j+1}}$ the subfan of $Y_{M_{j+1}}$ containing only those cones whose corresponding flags do *not* have two flats differing just by ϵ_{j+1} , see Fig. 6. Then

$\tau_j : Y'_{M_{j+1}} \rightarrow Y_{M_j}$ is a one-to-one map linear on the cones, cf. [Sh12]. Indeed, τ_j contracts precisely those cones of $Y_{M_{j+1}}$ which are parallel to $e_{\epsilon_{j+1}}$.

Y_{M_0} is a complete fan in $\mathbb{R}^{r(M)-1}$ and the lemma is trivial since the coefficients $\mathcal{F}_p = \Lambda^p \mathbb{Z}^{r(M)-1}$ are constant on all strata and we may deform γ into a general position (subdividing simplices in γ if needed to keep the chain strata-compatible). Inductively we suppose that the lemma holds for Y_{M_j} and the matroid H_j is loopless and then prove that the lemma holds for $Y_{M_{j+1}}$.

We denote by $\text{St}(e_{\epsilon_{j+1}})$ the complement of $Y'_{M_{j+1}}$ in $Y_{M_{j+1}}$. It really is the open star of $e_{\epsilon_{j+1}}$ (in the coarsest face structure of $Y_{M_{j+1}}$). Note that $\text{St}(e_{\epsilon_{j+1}}) \cong Y_{H_j} \times \mathbb{R}$.

If $E \subset \text{St}(e_{\epsilon_{j+1}})$ we may use the inductive assumption for projections to Y_{H_j} (it has smaller dimension) together with a deformation along a generic vector field parallel to $e_{\epsilon_{j+1}}$.

If $E \not\subset \text{St}(e_{\epsilon_{j+1}})$, that is E is contained in $Y'_{M_{j+1}}$ we have $\dim(\tau_j(E)) = \dim(E) = l$. Consider singular q -simplices from γ with the interiors mapped to $\text{St}(E)$ and such that their closures intersect E . These simplices form a chain γ_E which can be considered as a relative cycle modulo its boundary $\partial\gamma_E$. We have $\partial\gamma_E \cap E = \emptyset$. Furthermore, $\tau_j(\partial\gamma_E)$ is a $(q-1)$ -cycle in the $(n-1)$ -dimensional tropical manifold Y_{H_j} . By induction on dimension we may assume that $\tau_j(\partial\gamma_E) \cap \text{St}(e_{\epsilon_{j+1}})$ can be deformed in Y_{H_j} to a cycle with simplices without faces of dimension larger than $q-n+l$ whose relative interiors are contained in E . As $\text{St}(e_{\epsilon_{j+1}}) \cong Y_{H_j} \times \mathbb{R}$ such deformation lifts to $Y_{M_{j+1}}$ and can be extended to a deformation of γ in $Y_{M_{j+1}}$.

By induction on j there exists a tropical chain $b_j \in C_{q+1}(Y_{M_j}; \mathcal{F}_p)$ such that the relative interiors of k -faces of singular simplices of $\gamma'_j = \partial B_j - \tau_j(\gamma)$ are disjoint from E . This assumption holds for any face structure on Y_{M_j} , in particular for the one compatible with Y_{H_j} . Then the relative interiors of all q -dimensional simplices are disjoint from Y_{H_j} and we can form $\tilde{b}_j \in C_{q+1}(Y_{M_{j+1}}; \mathcal{F}_p)$ and $\tilde{\gamma}'_j \in C_{q+1}(Y_{M_{j+1}}; \mathcal{F}_p)$ by applying $\tau_j^{-1}|_{Y_{M_j} \setminus Y_{H_j}}$ to b_j and γ'_j . Note that $\partial\tilde{b}_j - \gamma - \tilde{\gamma}'_j$ must have the coefficients vanishing under τ_j , even though generated from the facets of $Y'_{M_{j+1}}$. Such coefficients must be supported on $\text{St}(e_{\epsilon_{j+1}})$ and thus we may apply the same reasoning as in the case of $E \subset \text{St}(e_{\epsilon_{j+1}})$.

Finally, let us now consider the sedentary case, that is let E be a sedentarity s face of $Y_M \times \mathbb{T}^s$ with $s = |I| > 0$. Let ξ_j be the divisorial vectors, and let $V_J := \wedge_{j \in J} \xi_j$ denote the divisorial $|J|$ -polyvector for each $J \subset I$. We will need to deform γ to γ' so that no $(q-s)$, or smaller, -dimensional face of a simplex σ in γ' meets $Y_M \times \{-\infty\}$ (here $\{-\infty\} \in \mathbb{T}^s$ is the point of sedentarity s). In $Y_M \times \mathbb{R}^I$ the groups \mathcal{F}_p split into the direct sum $\bigoplus_{J \subset I} \mathcal{F}_p^J$, where \mathcal{F}_p^J consists of elements divisible by the polyvector V_J , and no larger $V_{J'}$. (The splitting is not canonical, it depends on a chart). Accordingly, we have a decomposition $\gamma = \sum_{J \subset I} \gamma_J$ into cycles.

If $J \neq I$, that is there exists $j \notin J$, we may push γ_J from E with the help of a vector field parallel to x_j . Note that γ_J remains a cycle after such deformation as

ξ_j is not present in the coefficients of γ_J . Thus by induction on sedentarity we may assume $J = I$.

The cycle γ_I has coefficients in $\mathcal{F}_{p-s}^{Y_M} \otimes V_I$, and hence can be interpreted as a relative cycle modulo $\partial\mathbb{T}^I = \mathbb{T}^I \setminus \mathbb{R}^I$ with coefficients in $\mathcal{F}_{p-s}^{Y_M}$ (as V_I vanishes on $\partial\mathbb{T}^I$ and constant otherwise) and $(\mathbb{T}^I, \partial\mathbb{T}^I)$ is homeomorphic to the pair $\mathbb{R}^{s-1} \times (\mathbb{R}_{\geq 0}, \{0\})$ of a half-space and its boundary. Thus γ_I may be deformed to a product (after simplicial subdivision) of the relative fundamental cycle in the s -dimensional half-space with some $(q-s)$ -dimensional singular cycle. In particular, E will not meet any codimension $< s$ face of a q -simplex in a deformed cycle. \square

Remark 6.9. Let $\Sigma = \bigcup \sigma$ be an integral polyhedral fan (with its cones σ oriented). Then using the inclusion homomorphisms (2.1) we can form the complex $C_k^{(p)} := \bigoplus_{\dim \sigma = k} \mathcal{F}_p(\sigma)$. In case Σ is a matroidal fan the statement of Lemma 6.8 is equivalent to that the complex $C_{\bullet}^{(p)}$ has only the highest homology.

Remark 6.10. When X is not smooth the statement of the Lemma is not true. For example let X be a union of two 2-planes in \mathbb{R}^4 intersecting in a point. Consider an unframed path (that is cycle in $C_1(X; \mathcal{F}_0)$) through the vertex which starts in one plane and ends in the other plane. Any deformation of this path will still have to go through the vertex.

Corollary 6.11. *Let X be a tropical manifold. Then*

- (1) *Every class in $H_q(X; \mathcal{F}_p)$ is represented by a transversal cycle.*
- (2) *Every pair of classes in $H_{q'}(X; \mathcal{F}_{p'})$ and $H_{q''}(X; \mathcal{F}_{p''})$ is represented by a transversal pair of cycles.*
- (3) *If γ'_1, γ'_2 are two cycles which represent the same class in $H_{q'}(X; \mathcal{F}_{p'})$ and both form transversal pairs with a cycle $\gamma'' \in C_{q''}(X; \mathcal{F}_{p''})$, then there is $b \in C_{q'+1}(X; \mathcal{F}_{p'})$ which form a transversal pair with γ'' , and such that $\partial b = \gamma'_1 - \gamma'_2$.*

Proof. We may start from any tropical cycle and deform it to a transversal position by applying Lemma 6.8 stratum by stratum starting from 0-dimensional faces and then higher-dimensional strata. (Note that in a chart the open star of any face can intersect only faces of higher dimension).

Suppose that we have two transversal cycles. Since any stratum \mathcal{E} is a manifold we can make interiors of faces of the simplices from these cycles transversal in \mathcal{E} by a small deformation with the help of the usual Sard's theorem. In any chart this deformation extends to a small deformation in $\text{St}(\mathcal{E})$. Making this procedure stratum by stratum in the order of non-decreasing dimension we make any pair of cycles transversal. A similar argument applies to the relative cycle in the last statement of the corollary. \square

If $p' + p'' + q' + q'' = 2n$ we can give a numerical value to the product $\gamma' \cdot \gamma''$ by integrating the $(n - p' - p'')$ -form $\Omega_{\mathcal{E}_\tau}(\beta_{\sigma'} \wedge \beta_{\sigma''})$ over the $(q' + q'' - n)$ -simplex

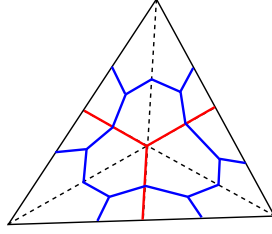

FIGURE 7. Intersection in σ' : $|\gamma''|$ (in red), $|\phi^k \cap \gamma'|$ (in blue).

τ . Indeed, since $\beta_{\sigma'} \wedge \beta_{\sigma''}$ is divisible by all divisorial directions corresponding to sedentary faces of $\tau = \sigma' \cap \sigma''$, the integration can be carried over in the quotient space to those (infinite) coordinates, thus giving a finite answer. Thus we define

$$(6.2) \quad \int \gamma' \cdot \gamma'' := \sum_{\tau \subset \sigma' \cap \sigma''} \int_{\tau} \Omega_{\mathcal{E}_{\tau}}(\beta_{\sigma'} \wedge \beta_{\sigma''}) \in \mathbb{R}.$$

The most interesting case to us is when $p' + q' = p'' + q'' = n$. Assuming $q' + q'' \geq n$ we can use the eigenwave action on one of the cycles in the pair to make them of complementary dimensions, after which the integration becomes just summing over the intersection points

$$\langle \gamma', \gamma'' \rangle := \int \gamma' \cdot \gamma'' = \sum_{x \in |\gamma'| \cap |\gamma''|} \Omega_x(\beta'_x \wedge \beta''_x),$$

where β'_x, β''_x are the coefficients at σ', σ'' for their intersection points $x \in \sigma' \cap \sigma''$.

Proposition 6.12. *Let $\gamma' = \sum \beta_{\sigma'} \sigma' \in C_{q'}(X; \mathcal{F}_{p'})$ and $\gamma'' = \sum \beta_{\sigma''} \sigma'' \in C_{q''}(X; \mathcal{F}_{p''})$ be a transversal pair of tropical cycles with $p' + q' = p'' + q'' = n$ and $q' + q'' \geq n$. Let $k := q' - p'' = q'' - p' \geq 0$. Then*

$$\langle \phi^k \cap \gamma', \gamma'' \rangle = \int \gamma' \cdot \gamma''.$$

Proof. First we need a representative of the cycle $\phi^k \cap \gamma'$ such that it still forms a transversal pair with γ'' . We fix first and second baricentric subdivisions of the simplices σ' in γ' . Then by transversality of γ'' we can assume that the intersection of each σ' with γ'' is supported on the star skeleton of σ' . That is $\sigma' \cap |\gamma''|$ consists of the k -simplices of the first baricentric subdivision of σ' spanned by the baricenters of the $q' - k, \dots, q'$ -dimensional faces τ of σ' . We label the k -simplices in the first baricentric subdivision of σ' by the flags of its faces $(\tau_0 \prec \dots \prec \tau_k)$.

Then the result of the wave action (5.4) from Description 1 on $\beta_{\sigma'} \sigma'$ gives the following chain (see Fig. 7)

$$\sum_{\tau_0 \prec \dots \prec \tau_k} (w_{\tau_0 \prec \dots \prec \tau_k} \wedge \beta_{\sigma'}) (\tau_0 \prec \widehat{\dots} \prec \tau_k),$$

where $w_{\tau_0 \prec \dots \prec \tau_k} \in W_k(\Delta_{\sigma'})$ is the polyvector associated to the simplex $(\tau_0 \prec \dots \prec \tau_k)$, and $(\tau_0 \prec \dots \prec \tau_k)$ is its star dual in the second barycentric subdivision (cf. definition in Section 5.2). When intersected with γ'' only the simplices $(\tau_0 \prec \dots \prec \tau_k)$ with maximal dimensional flags enter and we see that the result coincides with the definition of $\int \gamma' \cdot \gamma''$. \square

Proposition 6.13. *Let X be smooth. Then the intersection product $\langle \cdot, \cdot \rangle$ on cycles descends to a pairing on homology $H_q(X; \mathcal{F}_p) \otimes H_p(X; \mathcal{F}_q) \rightarrow \mathbb{R}$.*

Proof. Suppose that we have two homologous cycles $\gamma'_1 \in C_q(X; \mathcal{F}_p)$ and $\gamma'_2 \in C_q(X; \mathcal{F}_p)$. Let $b \in C_{q+1}(X; \mathcal{F}_p)$ be the connecting chain, i.e. $\partial b = \gamma'_1 - \gamma'_2$. According to Corollary 6.11 we can assume that each of the three γ'_1, γ'_2, b forms a transversal pair with a cycle $\gamma'' \in C_p(X; \mathcal{F}_q)$.

It is clear that $\partial(b \cdot \gamma'')$ coincides with the $\gamma'_1 \cdot \gamma'' - \gamma'_2 \cdot \gamma''$ on the interiors of the maximal strata of X . Thus it is enough to show that $b \cdot \gamma''$ has no boundary on codimension 1 mobile strata of X (according to Lemma 6.8 the intersection has no support on infinite simplices). This is local so we can work in a chart $\phi_\alpha : U_\alpha \rightarrow Y \subset \mathbb{T}^N$.

Let E be a codimension 1 face of Y and let D_1, \dots, D_k be the adjacent facets at E . We choose v_1, \dots, v_k , the corresponding primitive vectors such that $\sum_{i=1}^k v_i = 0$ (not just modulo the span of E). Let x be a point in the relative interior of E where b intersects γ'' , and let τ_1, \dots, τ_k be the intervals in the support of $b \cdot \gamma''$ adjacent to x . Each τ_i lies in D_i . Let $\beta'_i \in \mathcal{F}_p(D_i)$ and $\beta''_i \in \mathcal{F}_q(D_i)$ be the coefficients of the simplices of b and of γ'' , respectively, which intersect at the τ_i .

Since γ'' is a cycle, we have $\sum_i \beta''_i = 0$. We can write each

$$\beta''_i = v_i \wedge \bar{\alpha}''_i + \alpha''_i,$$

where $\bar{\alpha}''_i \in W_{q-1}(E)$ and $\alpha''_i \in W_q(E)$.

Recall that our tropical space X is smooth. In particular, this means that the fan at E modulo linear span of E is matroidal. That is, $\sum_{i=1}^k v_i = 0$ is the *only* linear relation among the v_i 's. This together with $\sum_i \beta''_i = 0$ implies that

$$\sum_{i=1}^k \alpha''_i = 0 \quad \text{and} \quad \bar{\alpha}''_1 = \dots = \bar{\alpha}''_k =: \bar{\alpha}''.$$

Similarly, $\sum_i \beta'_i = 0$ since ∂b cannot have support at x . Hence we can write

$$\beta'_i = v_i \wedge \bar{\alpha}' + \alpha'_i,$$

with $\sum \alpha'_i = 0$, $\alpha'_i \in W_p(E)$ and $\bar{\alpha}' \in W_{p-1}(E)$. Note that in the product

$$\beta'_i \wedge \beta''_i = (v_i \wedge \bar{\alpha}' + \alpha'_i) \wedge (v_i \wedge \bar{\alpha}'' + \alpha''_i) = v_i \wedge (\bar{\alpha}' \wedge \alpha''_i + \alpha'_i \wedge \bar{\alpha}'')$$

only the cross terms survive. Now we are ready to evaluate $\partial(b \cdot \gamma'')$ at x :

$$\begin{aligned} \sum_i \Omega_{\Delta_i} [v_i \wedge (\bar{\alpha}' \wedge \alpha_i'' + \alpha_i' \wedge \bar{\alpha}'')] &= \sum_i \Omega_{\Delta} (\bar{\alpha}' \wedge \alpha_i'' + \alpha_i' \wedge \bar{\alpha}'') \\ &= \Omega_{\Delta} (\bar{\alpha}' \wedge \sum_i \alpha_i'' + \sum_i \alpha_i' \wedge \bar{\alpha}'') = 0. \end{aligned}$$

□

Finally we restrict to the case when both γ', γ'' are cycles in $C_q(X; \mathcal{F}_p)$ with $p + q = n$. Then $\gamma' \cdot \gamma'' = \gamma'' \cdot \gamma'$. Indeed, assuming the orientation of τ is chosen, taking the product in the opposite order will result in the change of sign of the volume form $\Omega_{\mathcal{E}_\tau}$ according to the parity of p . On the other hand this parity will also affect the coefficients product: $\beta' \wedge \beta'' = (-1)^p \beta'' \wedge \beta'$, both effects cancel in $\Omega_{\mathcal{E}_\tau}(\beta' \wedge \beta'')$. This observation combined with Propositions 6.12 and 6.13 lead to the final statement.

Theorem 6.14. *Let X be compact and smooth. The product on cycles (6.2) descends to a symmetric bilinear form on $H_q(X; \mathcal{F}_p)$ for any $p + q = n$.*

Conjecture 6.15. *This form is non-degenerate.*

7. APPENDIX: KONSTRUKTOR AND THE EIGENWAVE ACTION IN THE REALIZABLE CASE

7.1. Tropical limit and the Steenbrink-Illusie spectral sequence. Suppose X is the tropical limit of a complex projective one-parameter degeneration $\mathcal{X} \rightarrow \Delta^*$. Then X is naturally polyhedral. We assume also that X is smooth. In this case the refined stable reduction theorem [KKMS73] allows us assume the following (see details in [IKMZ12]).

- X is unimodularly triangulated. This means that the finite cells are unimodular simplices and the infinite cells are products of unimodular simplices and unimodular cones spanned by the divisorial vectors.
- The finite part of X is identified with the dual Clemens complex of the degeneration with simple normal crossing central fiber $Z = \cup Z_\alpha$. This means that the components of Z are labelled by vertices of zero sedentarity and their intersections $Z_{\alpha_0} \cap \dots \cap Z_{\alpha_k} =: Z_\Delta$ are labelled by (finite) simplices $\Delta = \{\alpha_0 \dots \alpha_k\}$ of X of zero sedentarity.

Theorem 7.1. *Let X be a realizable smooth projective tropical variety. Then for $q \geq p$*

$$\phi^{q-p} : H_q(X; \mathcal{F}_p) \otimes \mathbb{Q} \rightarrow H_p(X; \mathcal{F}_q) \otimes \mathbb{Q}$$

is an isomorphism.

In this algebraic setting the eigenwave itself is an integral class in $H^1(X; \mathcal{W}_1)$ (recall that W carries a natural lattice). Hence in the statement we can avoid tensoring the tropical homology groups with \mathbb{R} . However its proof relies on the isomorphism in Theorem 7.2 which we can assert only over \mathbb{Q} . Although we believe that the theorem remains true over \mathbb{Z} its proof may be more delicate.

We will prove the theorem by comparing the eigenwave action with the classical monodromy action $T : H_k(X_t, \mathbb{Q}) \rightarrow H_k(X_t, \mathbb{Q})$, where X_t is a general fiber in \mathcal{X} . The idea that the monodromy can be represented by a cap product with certain cohomology class appeared before in the Calabi-Yau case. The second author [Zh00] proved a related conjecture of Gross [Gr98] that for toric hypersurfaces the monodromy can be described as the fiber-wise rotation by a natural section of the SYZ fibration. Later Gross and Siebert ([GS10], Section 5.1) explored the relation between the monodromy and the cap product in the logarithmic setting.

Notations:

- Δ or Δ' will always denote a finite face of X of sedentarity 0, in particular, a simplex.
- $H_{2l}(\Delta)[-r] = H_{2l}(Z_\Delta, \mathbb{Q})$, Tate twisted by $[-r, -r]$.
- $H_{2l}(k)[-r] = \bigoplus H_{2l}(\Delta)[-r]$, where Δ runs over all k -simplices in X as above.

First we recall the classical spectral sequence which calculates the limiting mixed Hodge structure of the family \mathcal{X} (see, e.g. [PS08], Chapter 11). This spectral sequence (from now on referred to as the Steenbrink-Illusie's, or SI for short) has the first term

$$E_{r, k-r}^1 = \bigoplus_{i \geq \max\{0, r\}} H_{k+r-2i}(2i-r)[r-i],$$

and it degenerates at E_2 abutting to homology of the smooth fiber X_t of \mathcal{Z} with the monodromy weight filtration.

Since all strata in Z are blow ups of projective spaces, the odd rows in Steenbrink-Illusie's E^1 vanish. Removing those and making shifts in the even rows we relabel the terms by

$$\tilde{E}_{q,p}^1 := E_{q-p, 2p}^1 = \bigoplus_{i \geq \max\{0, q-p\}} H_{2q-2i}(2i+p-q)[q-p-i].$$

The first differential $d = d' + d''$ consists of the map d' induced by strata inclusion and the Gysin map d'' :

$$\begin{aligned} d' : H_{2l}(k)[-r] &\rightarrow H_{2l}(k-1)[-r] \\ d'' : H_{2l}(k)[-r] &\rightarrow H_{2l-2}(k+1)[-r-1]. \end{aligned}$$

For reader's convenience we write the beginning of the \tilde{E}^1 term:

$$\begin{array}{ccccccc}
H_0(4)[-4] & & & & & & \\
\swarrow \nu & & & & & & \\
H_0(3)[-3] & \xleftarrow{d} & H_0(4)[-3] & & & & \\
& & \oplus H_2(2)[-2] & & & & \\
\swarrow \nu & & \swarrow \nu & & & & \\
H_0(2)[-2] & \xleftarrow{d} & H_0(3)[-2] & \xleftarrow{d} & H_0(4)[-2] & & \\
& & \oplus H_2(1)[-1] & & \oplus H_2(2)[-1] & & \\
& & & & \oplus H_4(0) & & \\
\swarrow \nu & & \swarrow \nu & & \swarrow \nu & & \\
H_0(1)[-1] & \xleftarrow{d} & H_0(2)[-1] & \xleftarrow{d} & H_0(3)[-1] & \xleftarrow{d} & H_0(4)[-1] \\
& & \oplus H_2(0) & & \oplus H_2(1) & & \oplus H_2(2) \\
\swarrow \nu & & \swarrow \nu & & \swarrow \nu & & \swarrow \nu \\
H_0(0) & \xleftarrow{d} & H_0(1) & \xleftarrow{d} & H_0(2) & \xleftarrow{d} & H_0(3) & \xleftarrow{d} & H_0(4)
\end{array}$$

The monodromy operator $\nu = \frac{1}{2\pi i} \log T$ acts along the diagonals by the Tate twist isomorphism $H_{2l}(k)[-r] \rightarrow H_{2l}(k)[-r-1]$ or by 0 if the corresponding group is missing (cf. [PS08], Chapter 11).

7.2. Propellers. Next we will give a combinatorial description of the SI groups and the differential in terms of *propellers* - the “local tropical cycles” in X .

Some more notations:

- Recall that $\Delta, \Delta', \Delta''$ always denote finite faces of X of sedentarity 0.
- We write $\Delta \prec_k \Delta'$ or $\Delta' \succ_k \Delta$, if Δ is a face of Δ' of codimension k .
- $\text{Link}_l(\Delta)$ consists of sets $\bar{q} = \{q_1, \dots, q_l\}$ where each q_i is either a vertex or a divisorial vector, such that the vertices of Δ together with elements of \bar{q} span a face (infinite, in case \bar{q} contains divisorial vectors) adjacent to Δ of dimension l higher. We denote the corresponding face by $\{\Delta\bar{q}\}$ and often drop the brackets from the notation (e.g., as below) when they become cumbersome.
- $\text{Link}_l^0(\Delta) \subset \text{Link}_l(\Delta)$ consists of those sets $\bar{q} = \{q_1, \dots, q_l\}$ where q_i are allowed to be only vertices (not the divisorial vectors). In this case $\{\Delta\bar{q}\}$ is finite.
- $\text{Vol}_{\Delta\bar{q}}$ is the integral volume element in the (oriented) face $\{\Delta\bar{q}\}$.

Let Δ be an oriented finite cell of sedentarity 0. One can naturally identify (see [IKMZ12] for details) the homology groups $H_{2l}(\Delta)$ with the space of local tropical

relative l -cycles around Δ . That is, we consider formal \mathbb{Q} -linear combinations

$$\sum_{\bar{q} \in \text{Link}_l(\Delta)} \rho_{\bar{q}} \{\Delta \bar{q}\}$$

of (possibly infinite) cells $\{\Delta \bar{q}\} \succ_l \Delta$ which are balanced along Δ . We call these local cycles *propellers* and abusing the notation we continue denoting this group by $H_{2l}(\Delta)$ (there is no Tate twist however).

Then one can identify the Gysin map $d'' : H_{2l}(\Delta) \rightarrow H_{2l-2}(\Delta')$ with the restriction of the propeller to a consistently oriented finite simplex $\Delta' \succ_1 \Delta$. Put together

$$(7.1) \quad d'' \left(\sum_{\bar{q} \in \text{Link}_l(\Delta)} \rho_{\bar{q}} \{\Delta \bar{q}\} \right) = \sum_{q \in \text{Link}_1^0(\Delta)} \left(\sum_{\bar{r} \in \text{Link}_{l-1}(\Delta q)} \rho_{q\bar{r}} \{\Delta q\bar{r}\} \right).$$

The inclusion map $d' : H_{2l}(\Delta) \rightarrow H_{2l}(\Delta')$, where $\Delta' = \Delta \setminus v$ is consistently oriented facet of Δ , is somewhat more tricky. Let $c = \sum_{\bar{q} \in \text{Link}_l(\Delta)} \rho_{\bar{q}} \{\Delta \bar{q}\}$ be an element in $H_{2l}(\Delta)$. For any $\bar{q} \in \text{Link}_l(\Delta)$ let $\{\Delta' \bar{q}\} = \{\Delta \bar{q} \setminus v\}$ be the corresponding cell containing Δ' . Then the image of $d'c$ in $H_{2l}(\Delta')$ will be

$$(7.2) \quad \sum_{\bar{q} \in \text{Link}_l(\Delta)} \rho_{\bar{q}} \{\Delta' \bar{q}\} + \sum_{\bar{r} \in \text{Link}_{l-1}(\Delta)} \rho_{v\bar{r}} \{\Delta \bar{r}\},$$

where the coefficients $\rho_{v\bar{r}} \in \mathbb{Q}$ are chosen to make the result balanced along Δ' . There is always a unique such choice (cf. [IKMZ12]), namely, the $\rho_{v\bar{r}}$ can be read off from the balancing condition for c along $\{\Delta \bar{r}\}$:

$$(7.3) \quad \sum_q \rho_{q\bar{r}} \overrightarrow{(\Delta' q)} + \rho_{v\bar{r}} \overrightarrow{(\Delta' v)} = 0 \quad \text{mod } \{\Delta' \bar{r}\},$$

where $\overrightarrow{(\Delta' q)}$ means the divisorial vector q , or the vector from any vertex of Δ' to q (well defined mod Δ') if q is a vertex, and same for $\overrightarrow{(\Delta' v)}$.

From now on we will not distinguish between the classical geometric Steenbrink-Illusie E_1 complex and its interpretation via complex of propellers. One of the main results in [IKMZ12] is the following statement.

Theorem 7.2 ([IKMZ12]). $\tilde{E}_{q,p}^2 \cong H_q(X; \mathcal{F}_p) \otimes \mathbb{Q}$.

7.3. Konstruktor. Now we provide another realization of the Steenbrink-Illusie's E_1 complex in terms of specific tropical simplicial chains. The collection of these chains which we call *konstruktor* forms a subcomplex of $C_{\bullet}^{bar}(X, \mathcal{F}_{\bullet})$, and we can refer to Theorem 7.2 to see that the inclusion is a quasi-isomorphism. A wonderful feature of the konstruktor is that the eigenwave acts on its elements precisely as the monodromy operator ν acts on the terms in the Steenbrink-Illusie's E_1 .

Let us fix the first barycentric subdivision of X . We elaborate a little bit on already used notation of the dual cell.

- For a pair $\Delta \succ \Delta'$ of finite simplices of sedentarity 0 in X , and $\bar{q} \in \text{Link}_l(\Delta)$ we let $\hat{\Delta}'_{\Delta\bar{q}}$ denote the dual cell to Δ' in the face $\{\Delta\bar{q}\}$ of X , that is the union of all simplices in the barycentric subdivision containing barycenters of both Δ' and $\{\Delta\bar{q}\}$.
- In the summation formulae to follow we assume the terms with $\hat{\Delta}'_{\Delta\bar{q}}$ are not present if Δ' is not a zero sedentarity finite face of $\{\Delta\bar{q}\}$.

Let Δ be a finite k -simplex of sedentarity 0 in X , and $r \leq k$ a non-negative integer. To any propeller, that is a local tropical l -cycle

$$c = \sum_{\bar{q} \in \text{Link}_l(\Delta)} \rho_{\bar{q}} \{\Delta\bar{q}\} \in H_{2l}(\Delta)$$

we associate a simplicial chain $c[-r] \in C_{k+l-r}^{\text{bar}}(X, \mathcal{F}_{l+r})$ as follows (note that $c[0]$ now has other meaning than just c):

$$c[-r] = \sum_{\bar{q} \in \text{Link}_l(\Delta)} \sum_{\substack{\Delta' \prec \Delta \\ \dim \Delta' = r}} (\rho_{\bar{q}} \text{Vol}_{\Delta'\bar{q}}) \hat{\Delta}'_{\Delta\bar{q}}.$$

The orientation of $\hat{\Delta}'_{\Delta\bar{q}}$ is consistent with the original orientation of Δ and the choice of the volume element $\text{Vol}_{\Delta'\bar{q}}$. Clearly for each r between 0 and k the map

$$(\cdot)[-r] : H_{2l}(k) \rightarrow C_{k+l-r}^{\text{bar}}(X, \mathcal{F}_{l+r})$$

is an injective group homomorphism. We denote its image in $C_{k+l-r}^{\text{bar}}(X, \mathcal{F}_{l+r})$ by $K_l(k)[-r]$.

Definition 7.3. The *konstruktor* is the subgroup of $C_{\bullet}^{\text{bar}}(X, \mathcal{F}_{\bullet})$ generated by the $K_l(k)[-r]$ for all k, l and r . Note that $K_l(k)[-r]$ intersect trivially for different triples k, l, r .

Next we want to show that for each p the $\oplus_r K_{p-r}(\bullet - p + 2r)[-r]$ is indeed a subcomplex of $C_{\bullet}^{\text{bar}}(X, \mathcal{F}_p)$ isomorphic to the SI complex $\tilde{E}_1^{\bullet, p}$. This follows at once from comparing the SI differentials $d = d' + d''$ with the simplicial boundary ∂ .

Proposition 7.4. $\partial(c[-r]) = (d'c)[-r] + (d''c)[-r - 1]$.

Proof. For the proof we need two linear algebra identities. Let σ', σ'' be two opposite faces in a unimodular simplex $\sigma = \{\sigma' \sigma''\}$. Then one has

$$\sum_{\tau'' \prec_1 \sigma''} \text{Vol}_{\sigma' \tau''} = \text{Vol}_{\sigma'} \wedge \text{Vol}_{\sigma''} = \sum_{\tau' \prec_1 \sigma'} \text{Vol}_{\tau' \sigma''},$$

where, say, the left equality easily follows from the case when σ' is a vertex. Here all τ' are oriented consistently with σ' , and all τ'' with σ'' . We will need this identity in the form

$$(7.4) \quad \sum_{\Delta' \prec_1 \Delta} \text{Vol}_{\Delta'\bar{q}} = \sum_{q \in \text{Link}_1^0(\Delta)} \text{Vol}_{\Delta\bar{q} \setminus q},$$

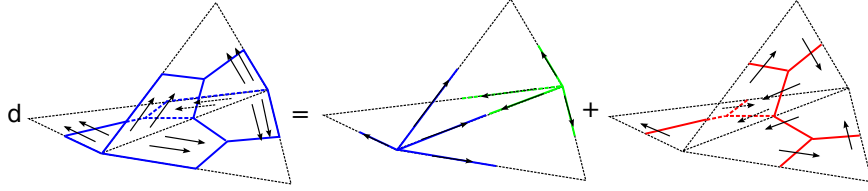

FIGURE 8. $d = d' + d'' : H_2(1) \rightarrow H_2(0) \oplus H_0(2)[-1]$. (Framing coefficient vectors are not to scale).

where Δ is a finite simplex and $\bar{q} \in \text{Link}_l(\Delta)$. Note that the divisorial vectors (if any) in \bar{q} just multiply both sides of the identity for finite simplices.

The second identity involves a relation among the balancing coefficients $\rho_{v\bar{r}}$ from (7.2) for $c = \sum \rho_{\bar{q}}\{\Delta\bar{q}\}$. One can show (cf. [IKMZ12]) that they satisfy a refined version of (7.3). Namely, for $\Delta' \prec \Delta \prec \{\Delta\bar{q}\}$ we have

$$\sum_q \rho_{q\bar{r}} \overrightarrow{(\Delta'q)} + \sum_{v \in \Delta \setminus \Delta'} \rho_{v\bar{r}} \overrightarrow{(\Delta'v)} = 0 \quad \text{mod } \{\Delta'\bar{r}\}$$

for faces $\Delta' \prec \Delta$ of codimension possibly higher than 1. Multiplying the above by $\text{Vol}_{\Delta'\bar{r}}$ we arrive at

$$(7.5) \quad \sum_{q \in \text{Link}_1(\Delta)} \rho_{q\bar{r}} \text{Vol}_{\Delta'q\bar{r}} = - \sum_{v \in \Delta \setminus \Delta'} \rho_{v\bar{r}} \text{Vol}_{\Delta'v\bar{r}}.$$

Now we are ready to prove the proposition. Let $c = \sum \rho_{\bar{q}}\{\Delta\bar{q}\}$, then we can write

$$c[-r] = \sum_{\substack{\Delta' \prec_{k-r} \Delta \\ \bar{q} \in \text{Link}_l(\Delta)}} (\rho_{\bar{q}} \text{Vol}_{\Delta'\bar{q}}) \hat{\Delta}'_{\Delta\bar{q}}.$$

The topological boundary of each cell $\Delta'_{\Delta\bar{q}}$ consists of two types:

- Type 1: cells in the form $\Delta''_{\Delta\bar{q}}$ for faces $\Delta'' \succ_1 \Delta'$ of $\{\Delta\bar{q}\}$. If the cell $\Delta'_{\Delta\bar{q}}$ includes divisorial directions then its coefficient $\text{Vol}_{\Delta'\bar{q}}$ in $c[-r]$ is divisible by all divisorial vectors. Hence the type 1 part of the boundary $\partial(c[-r])$ is, in fact, supported on the faces $\Delta''_{\Delta\bar{q}}$ for finite Δ'' . Thus $\Delta''_{\Delta\bar{q}}$ in the formulae below make sense.
- Type 2: cells in the form $\Delta'_{\Delta\bar{q}\setminus v}$ where v is a vertex or a divisorial vector in $\{\Delta\bar{q}\}$ which is not in Δ' .

Next we show that these two boundary types endowed with the framing correspond to the d'' and d' differentials in the SI complex, respectively, see Figure 8.

Boundary of type 1:

$$\begin{aligned}
& \sum_{\Delta', \bar{q}} \sum_{q \in \bar{q}} (\rho_{\bar{q}} \text{Vol}_{\Delta' \bar{q}}) \{\hat{\Delta}' q\}_{\Delta \bar{q}} + \sum_{\bar{q}} \sum_{\Delta' \prec_1 \Delta'' \prec \Delta} (\rho_{\bar{q}} \text{Vol}_{\Delta' \bar{q}}) \hat{\Delta}''_{\Delta \bar{q}} \\
&= \sum_{q \in \text{Link}_1^0(\Delta)} \left(\sum_{\substack{\Delta'' \prec \Delta q, \Delta'' \not\prec \Delta \\ \bar{r} \in \text{Link}_{l-1}(\Delta q)}} (\rho_{q\bar{r}} \text{Vol}_{\Delta'' \bar{r}}) \hat{\Delta}''_{\Delta q \bar{r}} + \sum_{\substack{\Delta'' \prec \Delta \\ \bar{r} \in \text{Link}_{l-1}(\Delta q)}} (\rho_{q\bar{r}} \text{Vol}_{\Delta'' \bar{r}}) \right) \hat{\Delta}''_{\Delta q \bar{r}} \\
&= \sum_{q \in \text{Link}_1^0(\Delta)} \sum_{\substack{\Delta'' \prec \Delta q \\ \bar{r} \in \text{Link}_{l-1}(\Delta q)}} (\rho_{q\bar{r}} \text{Vol}_{\Delta'' \bar{r}}) \hat{\Delta}''_{\Delta q \bar{r}}.
\end{aligned}$$

Here in the second summand we used the identity (7.4) for the pair $\Delta' \prec \Delta'' \bar{q}$. From (7.1) one can easily see that this coincides with $(d''c)[-r-1]$.

Boundary of type 2:

$$\begin{aligned}
& \sum_{q \in \text{Link}_1(\Delta)} \sum_{\substack{\Delta' \prec \Delta \\ \bar{r} \in \text{Link}_{l-1}(\Delta)}} (\rho_{q\bar{r}} \text{Vol}_{\tau q \bar{r}}) \hat{\Delta}'_{\Delta \bar{r}} + \sum_{v \in \Delta} \sum_{\substack{\Delta' \prec \Delta \setminus v \\ \bar{q} \in \text{Link}_l(\Delta)}} (\rho_{\bar{q}} \text{Vol}_{\Delta' \bar{q}}) \hat{\Delta}'_{\Delta \bar{q} \setminus v} \\
&= \sum_{\substack{v \in \Delta \\ \Delta' \prec \Delta \setminus v}} \left(\sum_{\bar{r} \in \text{Link}_{l-1}(\Delta)} (\rho_{v\bar{r}} \text{Vol}_{\tau v \bar{r}}) \hat{\Delta}'_{\Delta \bar{r}} + \sum_{\bar{q} \in \text{Link}_l(\Delta)} (\rho_{\bar{q}} \text{Vol}_{\tau \bar{q}}) \hat{\Delta}'_{\Delta \bar{q} \setminus v} \right).
\end{aligned}$$

Here in the first summand we used the identity (7.5) for each Δ', \bar{r} with the sign compensated by the orientation of $\hat{\Delta}'_{\Delta \bar{r}}$ and the choice of $\text{Vol}_{\tau v \bar{r}}$. Taking the sum of (7.2) over all vertices $v \in \Delta$ we easily identify the last expression with $(d'c)[-r]$. \square

Combining the above proposition with Theorem 7.2 we can conclude that the konstruktor complex can be used to calculate the tropical homology groups $H_q(X; \mathcal{F}_p)$:

Corollary 7.5. *The inclusion of the konstruktor $\oplus_r K_{p-r}(\bullet - p + 2r)[-r]$ into the complex $C_{\bullet}^{\text{bar}}(X; \mathcal{F}_p)$ is a quasi-isomorphism for each p .*

Finally, since all infinite cells in the konstruktor chains have coefficients divisible by the divisorial directions we can use the explicit description (5.2) of the eigenwave action on it. Then unveiling the konstruktor definition we arrive at the following.

Proposition 7.6. *For any $c \in H_{2l}(\Delta)$ one has $\phi \cap (c[-r]) = c[-r-1]$.*

Now we can combine all above observations to prove the claimed isomorphism

$$\phi^{q-p} : H_q(X; \mathcal{F}_p) \rightarrow H_p(X; \mathcal{F}_q).$$

Proof of Theorem 7.1. The cap product action of the eigenwave ϕ^{q-p} on the homology $H_q(X, \mathcal{F}_p)$ can be induced from its action on the konstruktor, which is a simplicial chain subcomplex. But it agrees there with the classical action of the

monodromy ν^{q-p} on the E_1 term of the SI spectral sequence. On the other hand it is well known that the ν^{q-p} induces an isomorphism on the associated graded pieces with respect to the monodromy weight filtration on $H_{p+q}(X_t)$, which are calculated on the E_2 term of the SI spectral sequence. \square

Acknowledgements. We are grateful to Ilia Itenberg for numerous useful discussions. We also wish to thank the referee for pointing out several mistakes and suggesting many exposition improvements. Finally we would like to thank the Max-Planck-Institut-für-Mathematik for its hospitality during the special program “Tropical Geometry and Topology”.

REFERENCES

- [AK06] F. Ardila and C. Klivans. *The Bergman Complex of a Matroid and Phylogenetic Trees*. J. Comb. Theory, Ser. B 96(1): 38-49 (2006).
- [Br97] G. Bredon. *Sheaf Theory*. Graduate Texts in Mathematics, 170 (2nd ed.), Berlin, New York: Springer-Verlag, 1997.
- [Gr98] M. Gross. *Special Lagrangian fibrations. I. Topology*. Integrable systems and algebraic geometry (Kobe/Kyoto, 1997), 156-193, World Sci. Publ., River Edge, NJ, 1998.
- [GS10] M. Gross and B. Siebert. *Mirror symmetry via logarithmic degeneration data, II*. J. Algebraic Geom. 19 (2010), no. 4, 679-780.
- [Ha77] R. Hartshorne. *Algebraic Geometry*. Graduate Texts in Mathematics, 52, Berlin, New York: Springer-Verlag, 1977.
- [IKMZ12] I. Itenberg, L. Katzarkov, G. Mikhalkin, I. Zharkov. *Tropical Homology*. In preparation.
- [KKMS73] G. Kempf, F. Knudsen, D. Mumford, B. Saint-Donat. *Toroidal Embeddings*. Lect. Notes in Math. 339, Springer 1973.
- [Mik06] G. Mikhalkin. *Tropical Geometry and its Application*. Proceedings of the International Congress of Mathematicians, Madrid 2006, 827-852.
- [MR12] G. Mikhalkin and J. Rau. Book in preparation.
- [PS08] C. Peters and J. Steenbrink. *Mixed Hodge structures*. Ergebnisse der Mathematik und ihrer Grenzgebiete, 52. Springer-Verlag, Berlin, 2008.
- [Sh12] K. Shaw. *Tropical intersection theory and surfaces*. Available at <http://www.math.toronto.edu/shawkm/>
- [Zh00] I. Zharkov. *Torus fibrations of Calabi-Yau hypersurfaces in toric varieties*. Duke Math. J. 101 (2000), no. 2, 237-257.

UNIVERSITÉ DE GENÈVE, MATHÉMATIQUES, VILLA BATTELLE, 1227 CAROUGE, SUISSE
E-mail address: grigory.mikhalkin@unige.ch

KANSAS STATE UNIVERSITY, 138 CARDWELL HALL, MANHATTAN, KS 66506 USA
E-mail address: zharkov@math.ksu.edu